

COMMERCIAL GAS WATER HEATERS



Ashland City, TN 37015
www.hotwater.com



WATER QUALITY Low Lead Content

POWER VENT/POWER DIRECT VENT GAS MODELS
WITH DIRECT SPARK IGNITION
MODELS BTX 100/ BTXL100 SERIES 130/131



WARNING: If the information in these instructions is not followed exactly, a fire or explosion may result causing property damage, personal injury or death.

- Do not store or use gasoline or other flammable vapors and liquids in the vicinity of this or any other appliance.
- WHAT TO DO IF YOU SMELL GAS:
 - Do not try to light any appliance.
 - Do not touch any electrical switch; do not use any phone in your building.
 - Immediately call your gas supplier from a neighbor's phone. Follow the gas supplier's instructions.
 - If you cannot reach your gas supplier, call the fire department.
- Installation and service must be performed by a qualified installer, service agency or the gas supplier.

Thank you for buying this energy efficient water heater. We appreciate your confidence in our products.



WARNING

Read and understand instruction manual and safety messages before installing, operating or servicing this water heater.

Failure to follow instructions and safety messages could result in death or serious injury.

Instruction manual must remain with water heater.

• **For Your Safety** •
AN ODORANT IS ADDED TO THE GAS USED BY THIS WATER HEATER.

ALL TECHNICAL AND WARRANTY QUESTIONS: SHOULD BE DIRECTED TO THE LOCAL DEALER FROM WHOM THE WATER HEATER WAS PURCHASED. IF YOU ARE UNSUCCESSFUL, CALL THE TECHNICAL SUPPORT PHONE NUMBER SHOWN ON THE WATER HEATER LABELING.

KEEP THIS MANUAL IN THE POCKET ON HEATER FOR FUTURE REFERENCE
WHENEVER MAINTENANCE ADJUSTMENT OR SERVICE IS REQUIRED.

TABLE OF CONTENTS





SAFE INSTALLATION, USE AND SERVICE.....	3	Filling The Water Heater.....	23
APPROVALS.....	3	INSTALLATION REQUIREMENTS FOR THE COMMONWEALTH OF MASSACHUSETTS.....	24
GENERAL SAFETY INFORMATION.....	4	VENTING INSTALLATION.....	25
Precautions.....	4	Vent Installation Considerations.....	25
Grounding Instructions.....	4	Approved Vent/Intake Material.....	25
Hydrogen Gas Flammable.....	4	Polypropylene Installations.....	26
INTRODUCTION.....	7	Vent Pipe Termination.....	27
Abbreviations Used.....	7	Planning The Vent System.....	27
Qualifications.....	7	Installation Of Horizontal Through The Wall Vent System.....	27
iCOMM™ & BACnet Compatible.....	7	Direct Vent Terminal Installation.....	28
Preparing For The Installation.....	7	Installation Sequence.....	28
DIMENSIONS AND CAPACITY DATA.....	8	Termination Clearances Sidewall Power Vent.....	29
Rough In Dimensions: 50 Gallon Unit.....	8	Termination Clearances Sidewall Direct Vent.....	30
Rough In Dimensions: 75 Gallon Unit.....	8	Vertical Vent Terminal Installation.....	31
FEATURES AND COMPONENTS.....	10	Direct Vent Diagram.....	32
Controls And Switches.....	13	Concentric Vent Installation.....	33
INSTALLATION CONSIDERATIONS.....	14	Low Profile Termination Installation.....	36
Locating The Water Heater.....	14	LIGHTING AND OPERATION LABELS.....	37
Insulation Blankets.....	15	TEMPERATURE REGULATION.....	38
Combustion Air And Ventilation.....	15	CONTROL SYSTEM OPERATION.....	39
Unconfined Space.....	16	Overview.....	39
Confined Space.....	16	Control System Navigation.....	39
Fresh Air Openings For Confined Spaces.....	16	User Settings & Control System Menus.....	42
Outdoor Air Through Two Openings.....	16	FOR YOUR INFORMATION.....	47
Outdoor Air Through One Opening.....	16	Start Up Conditions.....	47
Outdoor Air Through Two Horizontal Ducts.....	17	Operational Conditions.....	47
Air From Other Indoor Spaces.....	17	PERIODIC MAINTENANCE.....	48
INSTALLATION REQUIREMENTS.....	18	Venting System Inspection.....	48
Chemical Vapor Corrosion.....	18	Anode Rod INSPECTION.....	48
Water Piping.....	18	Powered Anode Rod (optional models).....	49
Power Supply.....	18	Temperature-Pressure Relief Valve Test.....	49
Mixing Valves.....	19	Draining and Flushing.....	49
Gas piping.....	19	Service.....	50
Gas Supply Systems.....	20	LEAKAGE CHECKPOINTS.....	51
Gas Pressure Requirements.....	20	TROUBLESHOOTING.....	52
Supply Gas Regulator.....	20	Installation Checklist.....	52
Dishwashing Machines.....	20	Sequence Of Operation.....	52
Space Heating And Potable Water System.....	21	Sequence Of Operation Flow Chart.....	53
Closed Water Systems.....	21	Operational Problems.....	54
Thermal Expansion.....	21	Fault And Alert Conditions.....	55
Temperature-Pressure Relief Valve.....	22	WIRING DIAGRAM.....	57
Condensate Piping.....	22	NOTES.....	58
Condensate Drain Installation.....	23	LIMITED WARRANTY.....	59
Installation Instructions.....	23		
High Altitude Installations.....	23		

SAFE INSTALLATION, USE AND SERVICE

The proper installation, use and servicing of this water heater is extremely important to your safety and the safety of others.

Many safety-related messages and instructions have been provided in this manual and on your own water heater to warn you and others of a potential injury hazard. Read and obey all safety messages and instructions throughout this manual. It is very important that the meaning of each safety message is understood by you and others who install, use, or service this water heater.

	<p>This is the safety alert symbol. It is used to alert you to potential personal injury hazards. Obey all safety messages that follow this symbol to avoid possible injury or death.</p>
---	---

	<p>DANGER indicates an imminently hazardous situation which, if not avoided, will result in injury or death.</p>
	<p>WARNING indicates a potentially hazardous situation which, if not avoided, could result in injury or death.</p>
	<p>CAUTION indicates a potentially hazardous situation which, if not avoided, could result in minor or moderate injury.</p>
	<p>CAUTION used without the safety alert symbol indicates a potentially hazardous situation which, if not avoided, could result in property damage.</p>

All safety messages will generally tell you about the type of hazard, what can happen if you do not follow the safety message, and how to avoid the risk of injury.

The California Safe Drinking Water and Toxic Enforcement Act requires the Governor of California to publish a list of substances known to the State of California to cause cancer, birth defects, or other reproductive harm, and requires businesses to warn of potential exposure to such substances.

This product contains a chemical known to the State of California to cause cancer, birth defects, or other reproductive harm. This water heater can cause low level exposure to some of the substances listed in the Act.

APPROVALS



GENERAL SAFETY INFORMATION

PRECAUTIONS

DO NOT USE THIS APPLIANCE IF ANY PART HAS BEEN EXPOSED TO FLOODING OR WATER DAMAGE. Immediately call a qualified service technician to inspect the water heater and to make a determination on what steps should be taken next.

If the unit is exposed to the following, do not operate heater until all corrective steps have been made by a qualified service technician.

1. External fire.
2. Damage.
3. Firing without water.

GROUNDING INSTRUCTIONS

This water heater must be grounded in accordance with the National Electrical Code and/or local codes. These must be followed in all cases. Failure to ground this water heater properly may also cause erratic control system operation.

This water heater must be connected to a grounded permanent wiring system; or an equipment grounding conductor must be run with the circuit conductors and connected to the equipment grounding terminal or lead on the water heater.

HYDROGEN GAS FLAMMABLE

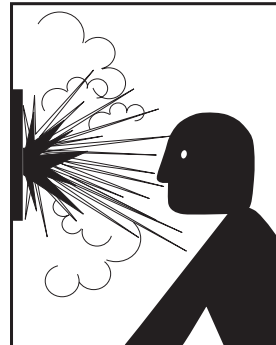

⚠️ WARNING

Explosion Hazard

- Flammable hydrogen gases may be present.
- Keep all ignition sources away from faucet when turning on hot water.

Hydrogen gas can be produced in a hot water system served by this water heater that has not been used for a long period of time (generally two weeks or more). Hydrogen gas is extremely flammable. To reduce the risk of injury under these conditions, it is recommended that a hot water faucet served by this water heater be opened for several minutes before using any electrical appliance connected to the hot water system. If hydrogen is present there will probably be an unusual sound such as air escaping through the pipe as the water begins to flow. THERE SHOULD BE NO SMOKING OR OPEN FLAME NEAR THE FAUCET AT THE TIME IT IS OPEN.

Verify the power to the water heater is turned off before performing any service procedures. The Enable/Disable switch on front panel disables the 24 volt gas valve. Electrical supply must be turned off at circuit breaker serving water heater.



⚠️ WARNING

Read and understand this instruction manual and the safety messages herein before installing, operating or servicing this water heater.

Failure to follow these instructions and safety messages could result in death or serious injury.

This manual must remain with the water heater.

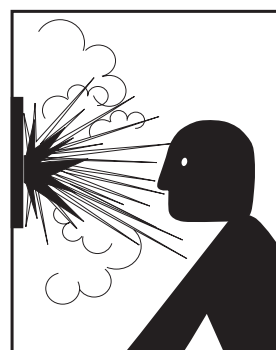

⚠️ WARNING

Explosion Hazard

- Overheated water can cause water tank explosion.
- Properly sized temperature and pressure relief valve must be installed in the opening provided.

⚠️ DANGER

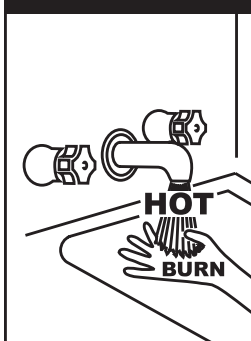

Water temperature over 125°F (52°C) can cause severe burns instantly resulting in severe injury or death.

Children, the elderly and the physically or mentally disabled are at highest risk for scald injury.

Feel water before bathing or showering.

Temperature limiting devices such as mixing valves must be installed when required by codes and to ensure safe temperatures at fixtures.

CAUTION

Improper installation, use and service may result in property damage.

- Do not operate water heater if exposed to flooding or water damage.
- Inspect anode rods regularly, replace if damaged.
- Install in location with drainage.
- Fill tank with water before operation.
- Properly sized thermal expansion tanks are required on all closed water systems.

Refer to this manual for installation and service.

GENERAL SAFETY INFORMATION

⚠ WARNING



- Before servicing the water heater, make sure the blower assembly is unplugged or the electrical supply to the water heater is turned "OFF".
- Label all wires prior to disconnection when servicing controls. Wiring error can cause improper and dangerous operation. Verify proper operation after servicing.
- Failure to do this could result in death, serious bodily injury, or property damage.

⚠ WARNING



Breathing Hazard - Carbon Monoxide Gas



- Install vent system in accordance with codes.
- Do not operate water heater if any part has been exposed to flooding or water damage.
- Special Consideration must be taken with installations above 10,100' (3,078m) for standard models.
- Do not operate if soot buildup is present.
- Do not obstruct water heater air intake with insulating jacket.
- Do not place chemical vapor emitting products near water heater.
- Gas and carbon monoxide detectors are available.
- No vent damper installation is compatible with this power vented water heater.
- Condensate lines (field supplied) must not be elevated above the exhaust elbow assembly drain outlet. This must be true for the entire length of the condensate lines including the exit into an appropriate drain.
- Condensate lines must be free and clear of debris and must not allow back flow through the lines. The condensate lines must be able to flow freely to an appropriate drain.
- Do not allow condensate lines to become crimped closed.
- Analyze the entire vent system to make sure that condensate will not become trapped in a section of vent pipe and therefore reduce the open cross sectional area of the vent.

Breathing carbon monoxide can cause brain damage or death.
Always read and understand instruction manual.

⚠ DANGER

⚠ Vapors from flammable liquids may explode and catch fire causing death or severe burns.

Do not use or store flammable products such as gasoline, solvents or adhesives in the same room or area near the water heater.

Keep flammable products:

1. far away from heater,
2. in approved containers,
3. tightly closed and
4. out of children's reach.

Water heater has a main burner and ignition device
The ignition device:

1. can come on at any time and
2. will ignite flammable vapors.

Vapors:

1. cannot be seen,
2. are heavier than air,
3. go a long way on the floor and
4. can be carried from other rooms to the ignition device by air currents.

GENERAL SAFETY INFORMATION

⚠️ WARNING

Fire or Explosion Hazard

- Do not store or use gasoline or other flammable vapors and liquids in the vicinity of this or any other appliance.
- Avoid all ignition sources if you smell gas.
- Do not expose water heater controls to excessive gas pressure.
- Use only the gas shown on the water heater rating plate.
- Maintain required clearances to combustibles.
- Keep ignition sources away from faucets after extended periods of non-use.



Read instruction manual before installing, using or servicing water heater.



⚠️ WARNING

Breathing Hazard - Carbon Monoxide Gas

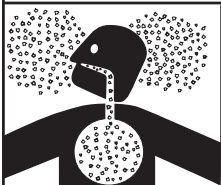

- Do not obstruct water heater air intake with insulating blanket.
- Gas and carbon monoxide detectors are available.
- Install water heater in accordance with the instruction manual.

Breathing carbon monoxide can cause brain damage or death. Always read and understand instruction manual.

CAUTION

Property Damage Hazard

- All water heaters eventually leak.
- Do not install without adequate drainage.

⚠️ WARNING

Electrical Shock Hazard



- Turn off power to the water heater before performing any service.
- Label all wires prior to disconnecting when performing service. Wiring errors can cause improper and dangerous operation.
- Verify proper operation after servicing.
- Failure to follow these instructions can result in personal injury or death.

⚠️ WARNING

Fire Hazard



For continued protection against risk of fire:

- Do not install water heater on carpeted floor.
- Do not operate water heater if exposed to flooding or water damage.

⚠️ WARNING

Fire and Explosion Hazard



- Use joint compound or Teflon tape compatible with propane gas.
- Leak test gas connections before placing the water heater in operation.
- Disconnect gas piping at main gas shutoff valve before leak testing.
- Install sediment trap in accordance with NFPA 54 or CAN/CSA B149.1.

⚠️ WARNING

Fire and Explosion Hazard



- Do not use water heater with any gas other than the gas shown on the rating plate.
- Excessive gas pressure to gas valve can cause serious injury or death.
- Turn off gas lines during installation.
- Contact a qualified installer or service technician for installation and service.

⚠️ WARNING

Jumping out control circuits or components can result in property damage, personal injury or death.

- Service should only be performed by a qualified service technician using proper test equipment.
- Altering the water heater controls and/or wiring in any way could result in permanent damage to the controls or water heater and is not covered under the limited warranty.



Any bypass or alteration of the water heater controls and/or wiring will result in voiding the appliance warranty.



INTRODUCTION

Thank You for purchasing this water heater. Properly installed and maintained, it should give you years of trouble free service.

ABBREVIATIONS USED

Abbreviations found in this Instruction Manual include :

- ANSI - American National Standards Institute
- ASME - American Society of Mechanical Engineers
- AHRI - Air-Conditioning, Heating and Refrigeration Institute
- NEC - National Electrical Code
- NFPA - National Fire Protection Association
- UL - Underwriters Laboratory
- CSA - Canadian Standards Association

QUALIFICATIONS

QUALIFIED INSTALLER OR SERVICE AGENCY

Installation and service of this water heater requires ability equivalent to that of a Qualified Agency (as defined by ANSI below) in the field involved. Installation skills such as plumbing, air supply, venting, gas supply and electrical supply are required in addition to electrical testing skills when performing service.

ANSI Z223.1 2006 Sec. 3.3.83: "Qualified Agency" - "Any individual, firm, corporation or company that either in person or through a representative is engaged in and is responsible for (a) the installation, testing or replacement of gas piping or (b) the connection, installation, testing, repair or servicing of appliances and equipment; that is experienced in such work; that is familiar with all precautions required; and that has complied with all the requirements of the authority having jurisdiction."

If you are not qualified (as defined by ANSI above) and licensed or certified as required by the authority having jurisdiction to perform a given task do not attempt to perform any of the procedures described in this manual. If you do not understand the instructions given in this manual do not attempt to perform any procedures outlined in this manual.

iCOMM™ & BACNET COMPATIBLE

This water heater is compatible with the iCOMM™ remote monitoring system. The iCOMM™ system hardware and monitoring service is purchased separately. It allows users to monitor critical operational, diagnostic and energy usage data from a secure web site.

The iCOMM™ system can automatically notify selected personnel via email and/or cellular phone text messages if operational problems or user defined Alert Conditions occur.

iCOMM™ system hardware is compatible with BACnet compliant supervisory controls and building management systems. For more information call 888 928-3702

PREPARING FOR THE INSTALLATION

1. Read the entire manual before attempting to install or operate the water heater. Pay close attention to the General Safety Information on Page 4 through Page 6. If you don't follow the safety rules, the water heater may not operate safely. It could cause property damage, injury and/or death.

This manual contains instructions for the installation, operation, and maintenance of the water heater. It also contains warnings throughout the manual that you must read and be aware of. All warnings and all instructions are essential to the proper operation of the water heater and your safety.

Detailed installation diagrams are also found in this manual. These diagrams will serve to provide the installer with a reference. It is essential that all venting, water piping, gas piping and wiring be installed as shown.

Particular attention should be given to the installation of thermometers at the locations indicated in the piping diagrams as these are necessary for checking the operation of the water heater.

The principal components of the water heater are identified in Features And Components on Page 10 & Page 11 in this manual. Use this reference to locate and identify various components on the water heater.

See the Installation Checklist and Troubleshooting on page 52. By using this checklist the user may be able to make minor operational adjustments and avoid unnecessary service calls. However, service and diagnostic procedures should only be performed by a Qualified Service Agency.

NOTE: Costs to correct installation errors are not covered under the limited warranty.

2. Be sure to turn off power when working on or near the electrical system of the water heater. Never touch electrical components with wet hands or when standing in water.
3. The installation must conform to all instructions contained in this manual and the local code authority having jurisdiction. These shall be carefully followed in all cases. Authorities having jurisdiction should be consulted before installation begins if there are any questions regarding compliance with local, state or national codes.

In the absence of local codes, the installation must comply with the current editions of the National Fuel Gas Code, ANSI Z223.1/NFPA 54 and the National Electrical Code, NFPA 70 or CAN/CSA-B149.1, the Natural Gas and Propane Installation Code and CSA C22.1, the Canadian Electrical Code. All documents are available from the Canadian Standards Association, 8501 East Pleasant Valley Road, Cleveland, OH 44131. NFPA documents are also available from the National Fire Protection Association, 1 Batterymarch Park, Quincy, MA 02269.

4. If after reading this manual you have any questions or do not understand any portion of the instructions, call the toll free number on the back cover of this manual for technical assistance. In order to expedite your request, please have the full Model, Serial and Series number of the water heater you are working with available for the technician. This information is located on the water heater's rating plate.
5. Carefully plan the placement of the water heater. Examine the location to ensure that it complies with the requirements in Locating The Water Heater on Page 14 and the Rough In Dimensions on Page 8.
6. For installation in California this water heater must be braced or anchored to avoid falling or moving during an earthquake. See instructions for correct installation procedures. Instructions may be obtained from California Office of the State Architect, 1102 Q Street, Suite 5100, Sacramento, CA 95811.
7. Massachusetts Code requires this water heater to be installed in accordance with Massachusetts 248-CMR 2.00: State Plumbing Code and 248-CMR 5. See Commonwealth of Massachusetts on Page 24.

DIMENSIONS AND CAPACITY DATA

ROUGH IN DIMENSIONS: 50 GALLON UNIT

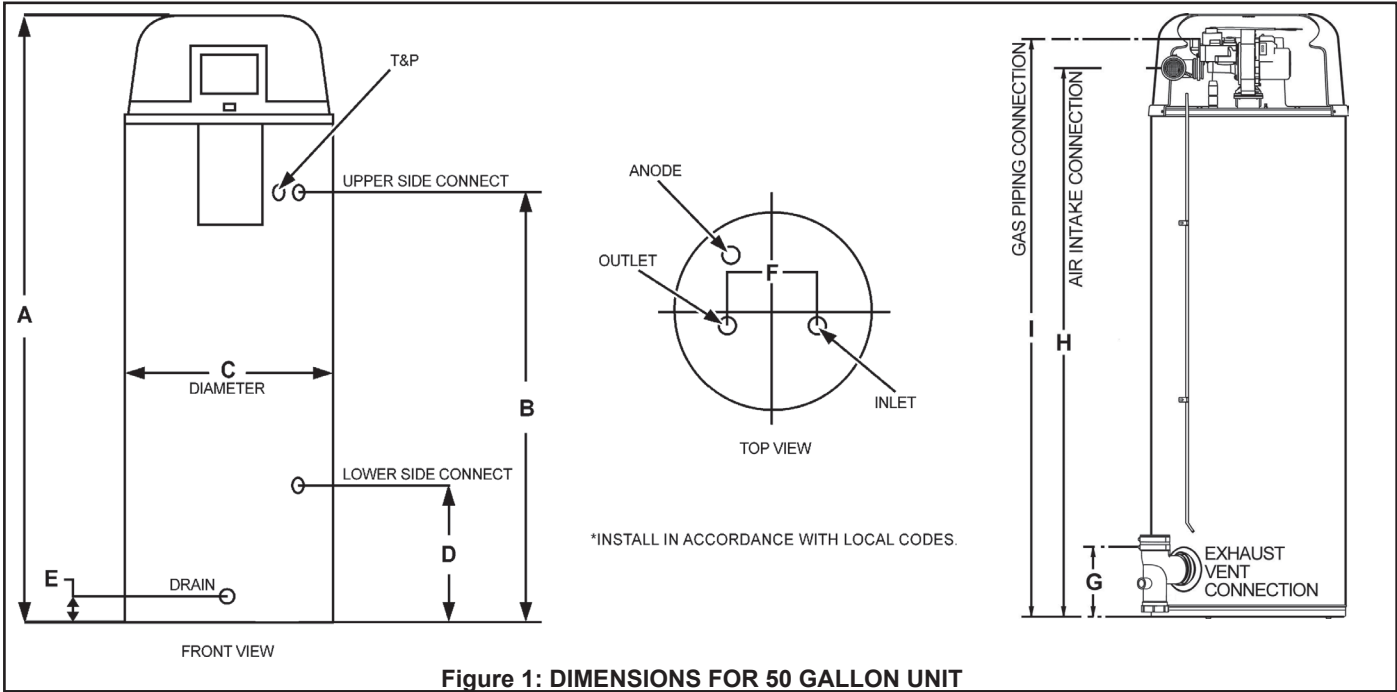

ROUGH IN DIMENSIONS: 75 GALLON UNIT

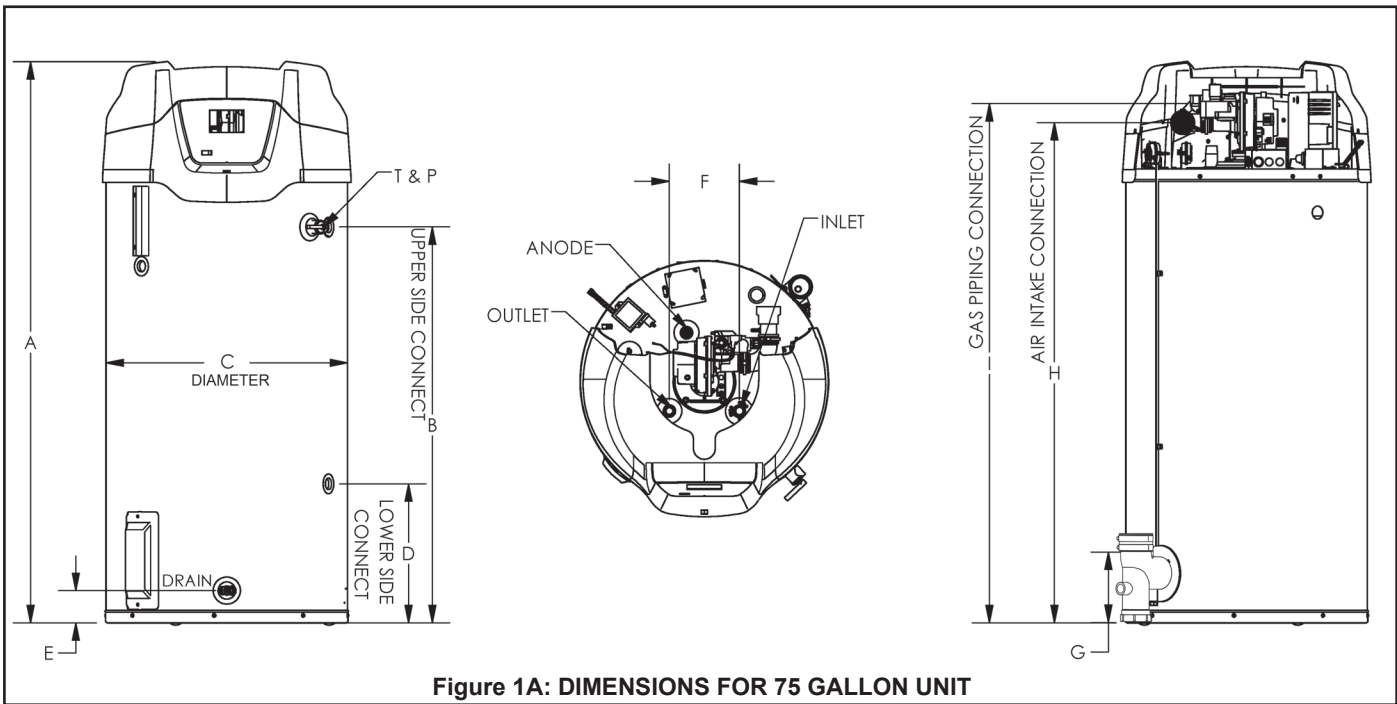

Table 1 – ROUGH-IN-DIMENSIONS

	Units	A	B	C	D	E	F	G	H	I
50G	Inches	66.75	49.25	22.00	15.75	3.00	8.00	8.00	62.00	65.00
	cm	169.5	125.09	55.88	40.00	7.62	20.32	20.32	157.48	165.1
75G	Inches	64.71	45.64	27.75	16.00	3.71	8.00	7.93	57.36	58.98
	cm	164.4	115.9	70.5	40.6	9.4	20.3	20.1	145.7	149.8

Top Inlet and Outlet: 50G - 3/4" NPT; 75G - 1" NPT
Side Inlet and Outlet: 3/4" NPT
Gas Inlet: 1/2" NPT
Condensate drain outlet: 1/2" NPT

DIMENSIONS AND CAPACITY DATA

Table 2 – CAPACITY, GAS AND ELECTRICAL CHARACTERISTICS

Approximate Capacity		*Manifold Pressure			Electrical Characteristics	
U.S. Gals.	Liters	Gas Type	"WC	kPA	Volts/Hz	Amperes
50	189	Nat./LP	0	0	120/60	<5
75	284	Nat./LP	0	0	120/60	<5

*The manifold pressure is the factory setting and is not adjustable. A negative pressure will be seen with just the blower running without the Gas Control Valve open.

All models - Maximum Supply Pressure: 14 inches W.C. (3.48kPa)

Minimum Supply Pressure for Natural Gas: 3.50" (.87kPa)

Minimum Supply Pressure for Propane Gas: 8.00" (1.99kPa)

Minimum pressure must be maintained under both load and no load (dynamic and static) conditions.

Table 3 – RECOVERY CAPACITIES

Input		Recovery Capacities													
Rating (Btu/hr)	Rating (kW)	Temp. Rise	F	30	40	50	60	70	80	90	100	110	120	130	140
			C	17	22	28	33	39	44	50	56	61	67	72	78
100,000	29.3	GPH		387	291	233	194	166	145	129	116	106	97	90	83
		LPH		1465	1102	882	734	628	549	488	439	401	367	341	314

Recovery capacity based on 96% thermal efficiency.

FEATURES AND COMPONENTS

50 GALLON UNIT

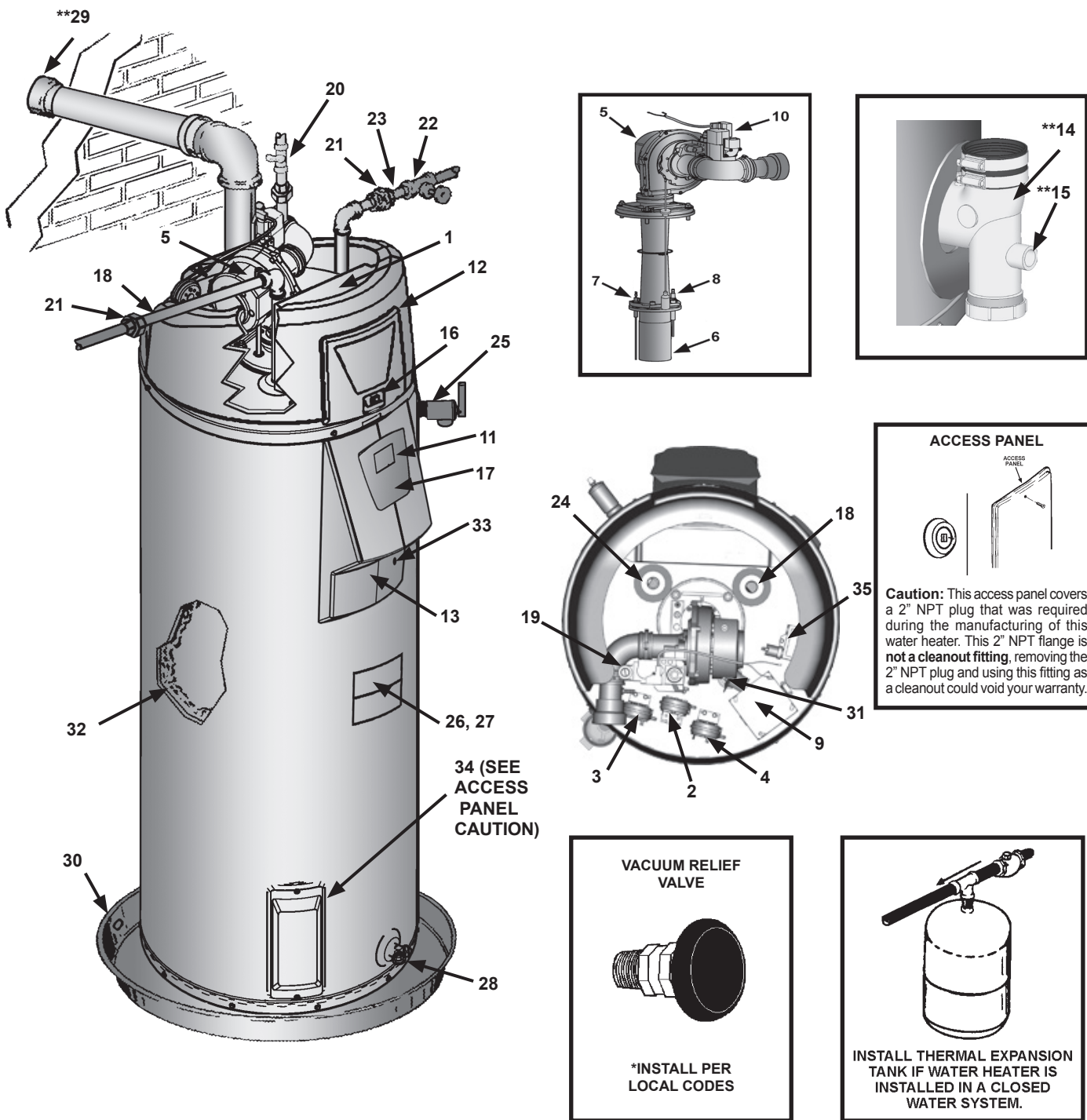

* CAUTION HARNESS HAS 120 VAC. IN OPERATION.
 ** See Venting Installation and Condensate Piping for more information.

Figure 1B: 50 GALLON UNIT

FEATURES AND COMPONENTS (CONT.)

75 GALLON UNIT

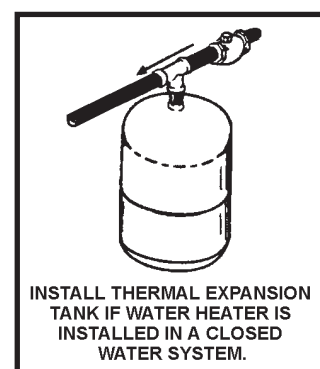
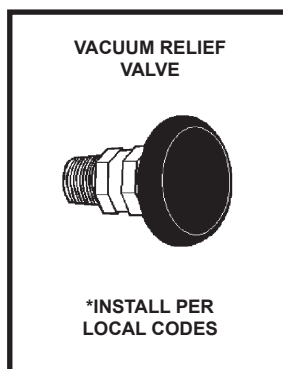
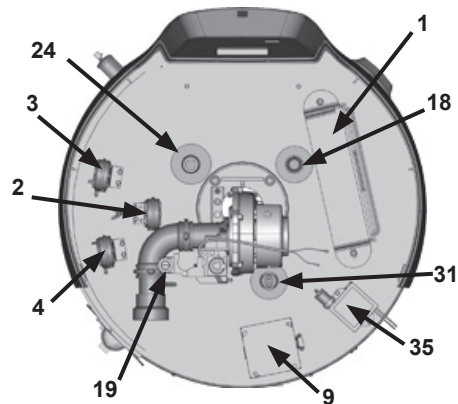
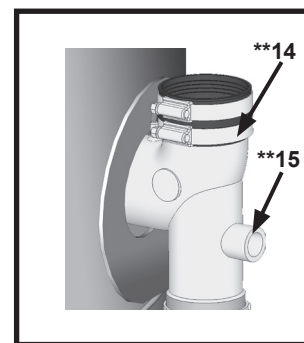
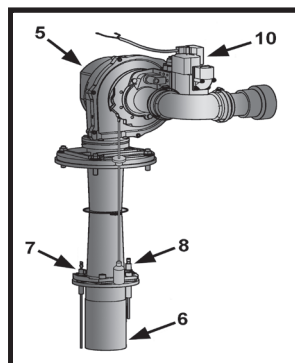
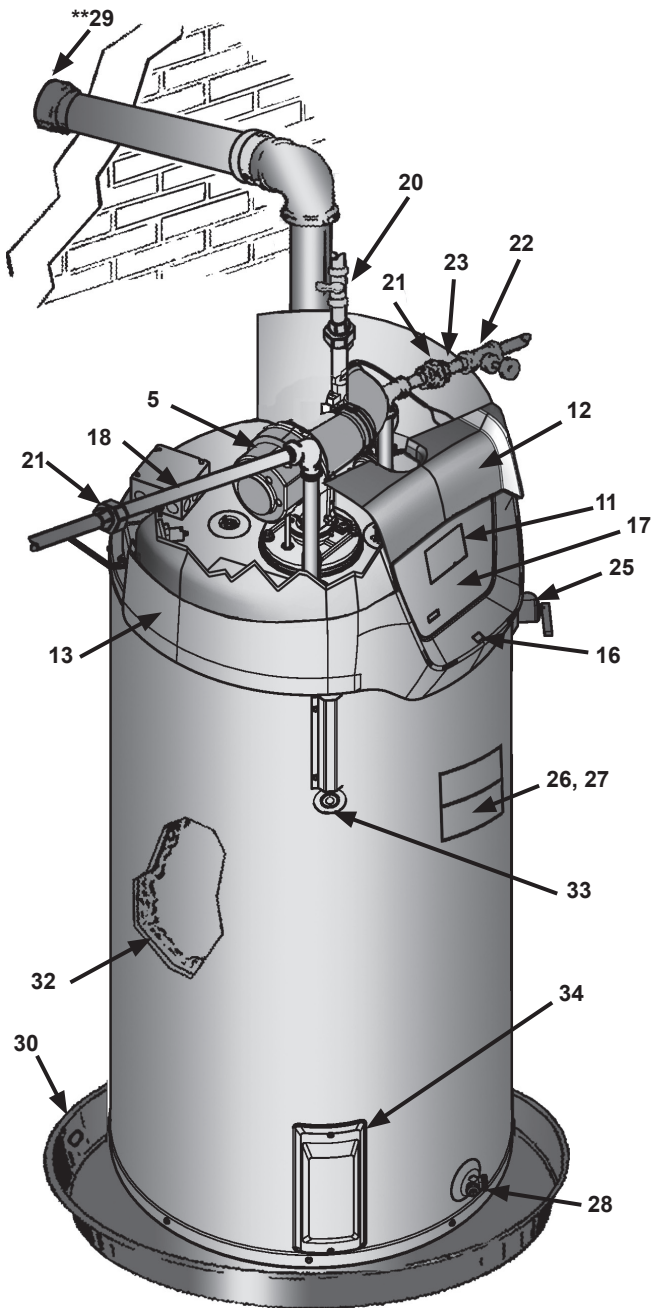

* CAUTION HARNESS HAS 120 VAC. IN OPERATION.
 ** See Venting Installation and Condensate Piping for more information.

Figure 1C: 75 GALLON UNIT

FEATURES AND COMPONENTS (CONT.)

- 1: Control Assembly
- 2: Blocked Intake Switch
- 3: Blocked Outlet Switch
- 4: Blower Prover Switch
- 5: Blower Assembly
- 6: Burner Assembly
- 7: Flame Sensor
- 8: Igniter Assembly
- 9: Junction Box
- 10: Gas Control Valve Assembly
- 11: Display Board
- 12: Top Plastic Enclosure
- 13: Display Enclosure
- ** 14: Exhaust Elbow Assembly
- ** 15: Condensate Drain Outlet
- 16: Enable / Disable Switch
- 17: Display Overlay
- 18: Hot Water Outlet
- 19: Gas Supply
- 20: Main Manual Gas Shutoff Valve
- 21: Union
- 22: Inlet Water Shutoff Valve
- 23: Cold Water Inlet
- 24: Inlet Dip Tube
- 25: T/P Relief Valve
- 26: Rating Plate
- 27: Labels
- 28: Drain Valve
- ** 29: Vent Terminal
- 30: Drain Pan
- 31: Anode Rod
- 32: Insulation
- 33: Temperature Probe
- 34: Access Door
- 35: Spark Module

CONTROLS AND SWITCHES

This model is provided with three pressure switches. These switches are essential to the safe and proper operation of the unit. All switches are wired in series. The controller is set up to shut the unit down whenever there is a failure of any of the switches. It is important to understand the purpose of each switch.

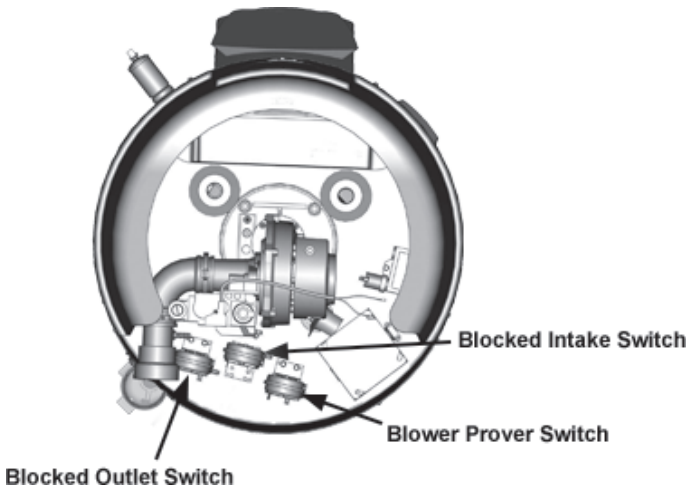

50 GALLON UNIT

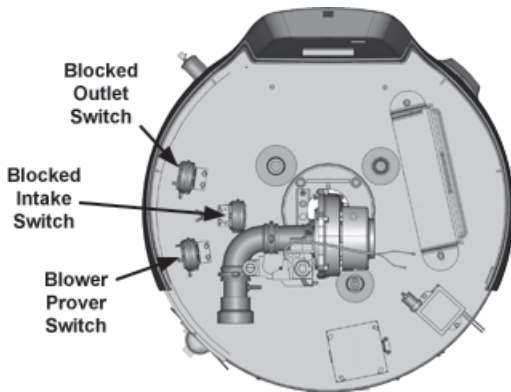

75 GALLON UNIT

Figure 2

BLOWER PROVER SWITCH

The Blower Prover Switch is provided on the heater to verify that the fan is operating. It is a positive pressure switch whose electrical contacts are normally open. When the fan increases the pressure in the burner, the pressure switch will allow the electrical contacts to

close. The pressure switch is connected to the blower pressure tap by a piece of tygon tubing. This tubing must be connected in order for the switch to change the electrical contacts. The controller requires that the electrical contacts on this air flow switch be open before it will allow the blower to come on.

BLOCKED OUTLET SWITCH

The Blocked Exhaust Switch is set up to shut the unit off when a build-up of positive pressure in the exhaust vent pipe occurs. This switch is a positive pressure switch that requires an increase in pressure to change the electrical contacts from normally closed to open. When this switch prevents the unit from igniting, most likely the exhaust is blocked by some means. Check to see if the condensate is allowed to flow freely from the exhaust elbow and for obstructions in the exhaust venting and exhaust vent terminal. Also verify that the vent length does not exceed the maximum allowed as shown in the Vent Section of this manual.

BLOCKED INTAKE SWITCH

The Blocked Intake Switch is set up to shut the unit off when a build-up of negative pressure in the intake air pipe occurs. This switch is a negative pressure switch that requires an increase in negative pressure to change the electrical contacts from normally closed to open. The switch is connected to the pressure tap on the PVC pipe connected to the inlet of the blower. When this switch prevents the unit from igniting, most likely the intake is blocked. Verify that the screen on the intake air connection (conventional vent), the intake air pipe and termination (direct vent installations) are free of obstructions that may prevent air from entering the unit. Insure the screen on intake air connection has been removed on direct vent installations, see Figure 14. Also verify the intake air pipe length does not exceed the maximum allowed as shown in the Vent Section of this manual.

WATER HEATING ENABLE/DISABLE SWITCH

IMPORTANT: The Enable/Disable switch listed in this manual is NOT an "on/off" switch and does not disconnect 120 volt power to the CCB and other heater components.

Water Heater's Enable/Disable Switch. When in the "Disabled" position the switch removes electrical power from the gas valve so that water heating is disabled. The display, CCB, and other electrical components will still be energized and the display will read "Water Heating Disabled".

SPARK IGNITER

The Spark Igniter is a device that ignites the main burner by spark. When high voltage is applied to the igniter, spark is generated to ignite the main burner.

CONFIGURATION KEY

The configuration key is located inside the control box. It provides for the ability of the heater to retain information collected over its lifetime, even if the control board is replaced because of failure.

The configuration key should stay with the heater.

INSTALLATION CONSIDERATIONS

LOCATING THE WATER HEATER

Carefully choose a location for the new water heater. The placement is a very important consideration for the safety of the occupants in the building and for the most economical use of the water heater.

CAUTION

Property Damage Hazard

- All water heaters eventually leak.
- Do not install without adequate drainage.

Whether replacing an existing water heater or installing the water heater in a new location observe the following critical points:

1. The water heater must be located indoors.
2. The water heater must not be located in an area where it will be subject to freezing temperatures.
3. Locate the water heater so it is protected and not subject to physical damage by a moving vehicle.
4. Locate the water heater on a level surface.
5. Locate the water heater near a floor drain. The water heater should be located in an area where leakage of the tank or connections will not result in damage to the area adjacent to the water heater or to lower floors of the structure. When such locations cannot be avoided, it is recommended that a metal drain pan, piped to adequate drain, be installed under the water heater. Drain pan should be fabricated with sides at least 2" deep with diameter at least 2" greater than diameter of heater. Pan must not restrict combustion air flow.
6. Locate the water heater close to the point of major hot water usage.
7. Locate the water heater close to a 120 VAC power supply. See Power Supply on Page 18 for requirements.
8. Locate the water heater where an adequate supply of fresh air for combustion and ventilation can be obtained. See Combustion Air and Ventilation on Page 15.
9. Locate the water heater where the vent and intake air piping, when installed, will remain within the maximum equivalent lengths allowed. See Venting Installation on page 25.
10. Do not locate the water heater where noise (such as the Combustion Blower) during normal operation will be objectionable in adjacent areas.
11. Do not locate the water heater where the subsequent installation of the vent (exhaust) or intake air terminations would be objectionable due to noise at the termination(s). This includes locations close to or across from windows and doors. See Venting Installation on page 25.

Do not locate water heater areas where flammable liquids (vapors) are likely to be present or stored (garages, storage and utility areas, etc.): Flammable liquids (such as gasoline, solvents, propane (LP or butane, etc.) and other substances

(such as adhesives, etc.) emit flammable vapors which can be ignited by a gas water heater's ignition device or main burner. The resulting flashback and fire can cause death or serious burns to anyone in the area.

Also, the water heater must be located and/or protected so it is not subject to physical damage by a moving vehicle.

WARNING

Fire or Explosion Hazard

- Do not store or use gasoline or other flammable vapors and liquids in the vicinity of this or any other appliance.
- Avoid all ignition sources if you smell LP gas.
- Do not expose water heater control to excessive gas pressure.
- Use only gas shown on rating plate.
- Maintain required clearances to combustibles.
- Keep ignition sources away from faucets after extended period of non-use.



Read instruction manual before installing, using or servicing water heater.



DANGER



⚠ Vapors from flammable liquids may explode and catch fire causing death or severe burns.

Do not use or store flammable products such as gasoline, solvents or adhesives in the same room or area near the water heater.

Keep flammable products:

1. far away from heater,
2. in approved containers,
3. tightly closed and
4. out of children's reach.

Water heater has a main burner and ignition device
The ignition device:

1. can come on at any time and
2. will ignite flammable vapors.

Vapors:

1. cannot be seen,
2. are heavier than air,
3. go a long way on the floor and
4. can be carried from other rooms to the ignition device by air currents.

When the water heater is installed directly on carpeting, the water heater shall be installed on a metal or wood panel extending beyond the full width and depth of the water heater by at least 3 in (76.2 mm) in any direction or, if the water heater is installed in an alcove or closet, the entire floor shall be covered by the panel. The panel must be strong enough to carry the weight of the heater when full of water.

⚠ WARNING
Fire or Explosion Hazard

Read instruction manual before installing, using or servicing water heater.

- Improper use may result in fire or explosion.
- Maintain required clearances to combustibles.



Minimum clearances between the water heater and combustible construction are 0 inch at the sides and rear, 5.5" (14.0 cm) from the front and 18" (45.7 cm) from the top. (Standard clearance.) If clearances stated on the heater differ from standard clearances, install water heater according to clearances stated on the heater.

Adequate clearance 30" (76 cm) for servicing this water heater should be considered before installation, such as changing the anode rods, control system components and gas control valve.

A minimum clearance of 5.5" (14.0 cm) must be allowed for access to replaceable and/or serviceable parts such as the thermostats, drain valve, condensate drain, temperature-pressure relief valve, clean out opening, and the vent connection (exhaust elbow).

When installing the heater, consideration must be given to proper location. Location selected should be as close to the wall as practicable and as centralized with the water piping system as possible.

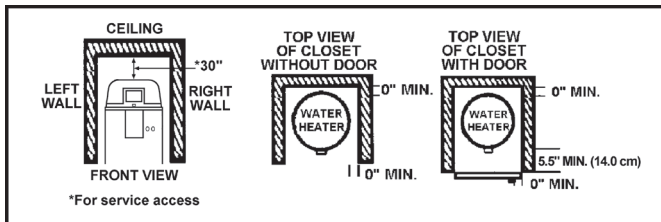



Figure 3: CLEARANCES

INSULATION BLANKETS

⚠ WARNING
Breathing Hazard - Carbon Monoxide Gas



- Do not obstruct water heater air intake with insulating blanket.
- Gas and carbon monoxide detectors are available.
- Install water heater in accordance with the instruction manual.

Breathing carbon monoxide can cause brain damage or death. Always read and understand instruction manual.

Insulation blankets are available to the general public for external use on gas water heaters but are not necessary with these products. The purpose of an insulation blanket is to reduce the standby heat loss encountered with storage tank heaters. Your water heater meets or exceeds the Energy Policy Act standards with respect to insulation and standby loss requirements, making an insulation blanket unnecessary.

Should you choose to apply an insulation blanket to this heater, you should follow these instructions (For identification of components

mentioned below, see Figure 1B & Figure 1C). Failure to follow these instructions can restrict the air flow required for proper combustion, potentially resulting in fire, asphyxiation, serious personal injury or death.

- Do not apply insulation to the top of the water heater, as this will interfere with safe operation of the blower assembly.
- Do not cover the control system LCD on top of the water heater.
- Do not cover the outer door, thermostat or temperature & pressure relief valve.
- Do not cover the instruction manual. Keep it on the side of the water heater or nearby for future reference.
- Do obtain new warning and instruction labels from the manufacturer for placement on the blanket directly over the existing labels.
- Do inspect the insulation blanket frequently to make certain it does not sag, thereby obstructing combustion air flow.

COMBUSTION AIR AND VENTILATION

A gas water heater cannot operate properly without the correct amount of air for combustion. Do not install in a confined area such as a closet, unless you provide air as shown in the Locating The Water Heater section. Never obstruct the flow of ventilation air. If you have any doubts or questions at all, call your gas supplier. Failure to provide the proper amount of combustion air can result in a fire or explosion and cause death, serious bodily injury, or property damage.

⚠ WARNING
Breathing Hazard - Carbon Monoxide Gas



- Install water heater in accordance with the instruction manual and NFPA 54 or CAN/CSA-B149.1
- To avoid injury, combustion and ventilation air must be taken from outdoors.
- Do not place chemical vapor emitting products near water heater.

Breathing carbon monoxide can cause brain damage or death. Always read and understand instruction manual.

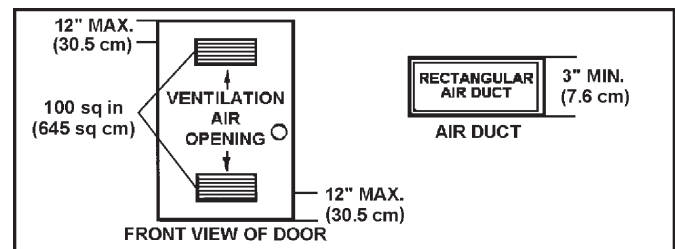

Figure 4: COMBUSTION AIR AND VENTILATION

If this water heater will be used in beauty shops, barber shops, cleaning establishments, or self-service laundries with dry cleaning equipment, it is imperative that the water heater(s) be installed direct vent so that all air for combustion and ventilation is taken from outdoors.

Propellants of aerosol sprays and volatile compounds, (cleaners, chlorine based chemicals, refrigerants, etc.) in addition to being highly flammable in many cases, will also react to form corrosive acids when exposed to the combustion products of the water heater. The results can be hazardous, and also cause product failure.

UNCONFINED SPACE

An Unconfined Space is one whose volume IS NOT LESS THAN 50 cubic feet per 1,000 Btu/hr (4.8 cubic meters per kW) of the total input rating of all appliances installed in the space. Rooms communicating directly with the space, in which the appliances are installed, through openings not furnished with doors, are considered a part of the unconfined space.

Makeup air requirements for the operation of exhaust fans, kitchen ventilation systems, clothes dryers and fireplaces shall also be considered in determining the adequacy of a space to provide combustion, ventilation and dilution air.

UNUSUALLY TIGHT CONSTRUCTION

In unconfined spaces in buildings, infiltration may be adequate to provide air for combustion, ventilation and dilution of flue gases. However, in buildings of unusually tight construction (for example, weather stripping, heavily insulated, caulked, vapor barrier, etc.) additional air must be provided using the methods described in the Confined Space section that follows.

CONFINED SPACE

A Confined Space is one whose volume IS LESS THAN 50 cubic feet per 1,000 Btu/hr (4.8 cubic meters per kW) of the total input rating of all appliances installed in the space.

Openings must be installed to provide fresh air for combustion, ventilation and dilution in confined spaces. The required size for the openings is dependent on the method used to provide fresh air to the confined space AND the total Btu/hr input rating of all appliances installed in the space.

DIRECT VENT APPLIANCES

Appliances installed in a Direct Vent configuration that derive all air for combustion from the outdoor atmosphere through sealed intake air piping are not factored in the total appliance input Btu/hr calculations used to determine the size of openings providing fresh air into confined spaces.

EXHAUST FANS

Where exhaust fans are installed, additional air shall be provided to replace the exhausted air. When an exhaust fan is installed in the same space with a water heater, sufficient openings to provide fresh air must be provided that accommodate the requirements for all appliances in the room and the exhaust fan. Undersized openings will cause air to be drawn into the room through the water heater's vent system causing poor combustion. Sooting, serious damage to the water heater and the risk of fire or explosion may result. It can also create a risk of asphyxiation.

LOUVERS AND GRILLES

The free areas of the fresh air openings in the instructions that follow do not take in to account the presence of louvers, grilles or screens in the openings.

The required size of openings for combustion, ventilation and dilution air shall be based on the net free area of each opening. Where the free area through a design of louver or grille or screen is known, it shall be used in calculating the size of opening required to provide the free area specified. Where the louver and grille design and free area are not known, it shall be assumed that wood louvers will have 25% free area and metal louvers and grilles will have 75% free area. Non motorized louvers and grilles shall be fixed in the open position.

FRESH AIR OPENINGS FOR CONFINED SPACES

The following instructions shall be used to calculate the size, number and placement of openings providing fresh air for combustion, ventilation and dilution in confined spaces. The illustrations shown in this section of the manual are a reference for the openings that provide fresh air into confined spaces only. **DO NOT** refer to these illustrations for the purpose of vent installation. See Venting Installation on Page 25 for complete venting installation instructions.

OUTDOOR AIR THROUGH TWO OPENINGS

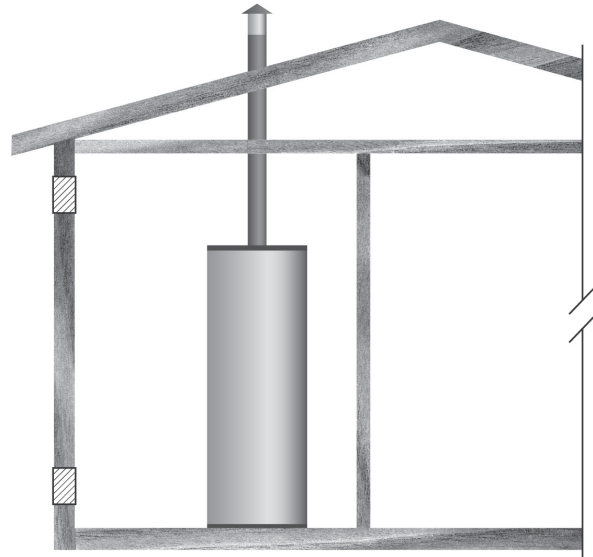

Figure 5

The confined space shall be provided with two permanent openings, one commencing within 12 inches (300 mm) of the top and one commencing within 12 inches (300 mm) of the bottom of the enclosure. The openings shall communicate directly with the outdoors. See Figure 5.

Each opening shall have a minimum free area of 1 square inch per 4,000 Btu/hr (550 mm² per kW) of the aggregate input rating of all appliances installed in the enclosure. Each opening shall not be less than 100 square inches (645 cm²).

OUTDOOR AIR THROUGH ONE OPENING

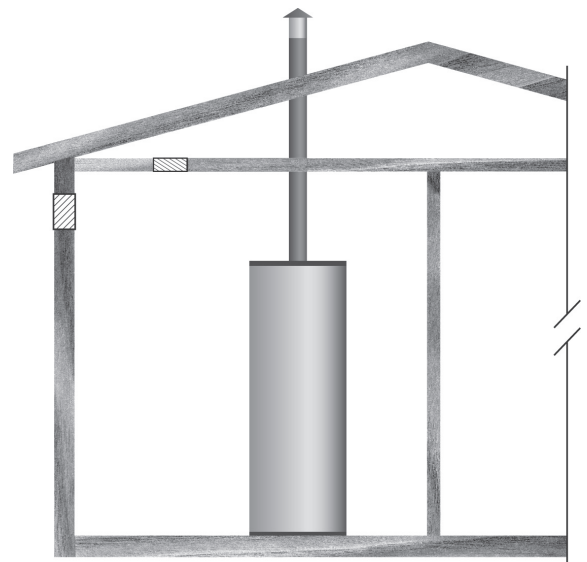

Figure 6

Alternatively a single permanent opening, commencing within 12 inches (300 mm) of the top of the enclosure, shall be provided. See Figure 6. The water heater shall have clearances of at least 1 inch (25 mm) from the sides and back and 6 inches (150 mm) from the front of the appliance. The opening shall directly communicate with the outdoors or shall communicate through a vertical or horizontal duct to the outdoors or spaces that freely communicate with the outdoors and shall have a minimum free area of the following:

1. 1 square inch per 3000 Btu/hr (733 mm² per kW) of the total input rating of all appliances located in the enclosure, and
2. Not less than the sum of the areas of all vent connectors in the space.

OUTDOOR AIR THROUGH TWO HORIZONTAL DUCTS

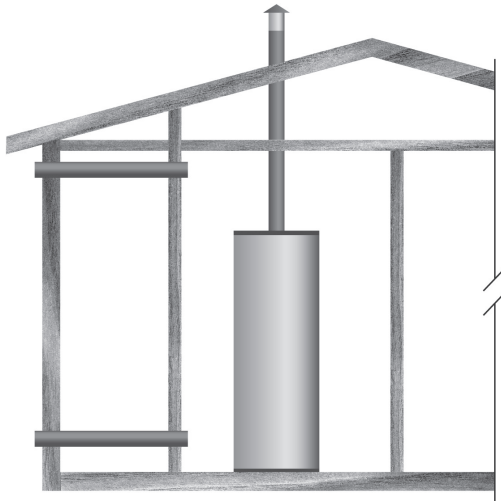

Figure 7

The confined space shall be provided with two permanent horizontal ducts, one commencing within 12 inches (300 mm) of the top and one commencing within 12 inches (300 mm) of the bottom of the enclosure. The horizontal ducts shall communicate directly with the outdoors. See Figure 7.

Each duct opening shall have a minimum free area of 1 square inch per 2,000 Btu/hr (1100 mm² per kW) of the aggregate input rating of all appliances installed in the enclosure.

When ducts are used, they shall be of the same cross sectional area as the free area of the openings to which they connect. The minimum dimension of rectangular air ducts shall be not less than 3 inches.

AIR FROM OTHER INDOOR SPACES

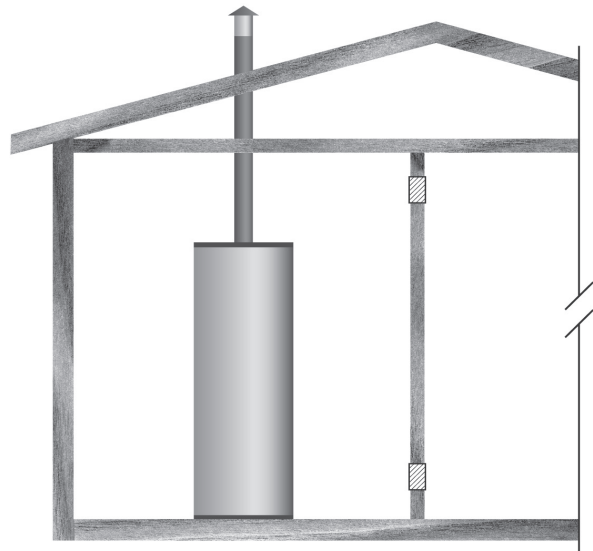

Figure 8

The confined space shall be provided with two permanent openings, one commencing within 12 inches (300 mm) of the top and one commencing within 12 inches (300 mm) of the bottom of the enclosure. See Figure 8.

Each opening shall communicate directly with an additional room(s) of sufficient volume so that the combined volume of all spaces meets the criteria for an Unconfined Space.

Each opening shall have a minimum free area of 1 square inch per 1,000 Btu/hr (2200 mm² per kW) of the aggregate input rating of all appliances installed in the enclosure. Each opening shall not be less than 100 square inches (645 cm²).

INSTALLATION REQUIREMENTS

CHEMICAL VAPOR CORROSION

Corrosion of the flueways and vent system may occur if air for combustion contains certain chemical vapors. Such corrosion may result in failure and risk of asphyxiation.

Spray can propellants, cleaning solvents, refrigerator and air conditioning refrigerants, swimming pool chemicals, calcium and sodium chloride (water softener salt), waxes, and process chemicals are typical compounds which are potentially corrosive.

Do not store products of this sort near the heater. Also, air which is brought in contact with the heater should not contain any of these chemicals. If necessary, uncontaminated air should be obtained from remote or outside sources. The limited warranty is voided when failure of water heater is due to a corrosive atmosphere. (See limited warranty for complete terms and conditions).

WATER PIPING

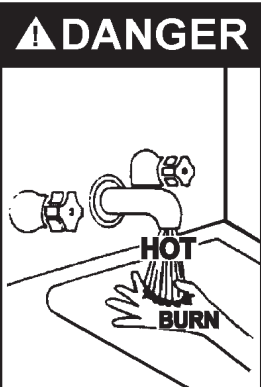
	<p>⚠ DANGER</p> <p>Water temperature over 125°F (52°C) can cause severe burns instantly resulting in severe injury or death.</p> <p>Children, the elderly, and the physically or mentally disabled are at highest risk for scald injury.</p> <p>Feel water before bathing or showering.</p> <p>Temperature limiting valves are available.</p> <p>Read instruction manual for safe temperature setting.</p>
---	---

HOTTER WATER CAN SCALD:

Water heaters are intended to produce hot water. Water heated to a temperature which will satisfy space heating, clothes washing, dish washing, cleaning and other sanitizing needs can scald and permanently injure you upon contact. Some people are more likely to be permanently injured by hot water than others. These include the elderly, children, the physically or developmentally disabled. If anyone using hot water fits into one of these groups or if there is a local code or state law requiring a certain temperature water at the hot water tap, then you must take special precautions. In addition to using the lowest possible temperature setting that satisfies your hot water needs, a means such as a mixing valve should be used at the hot water taps used by these people or at the water heater, see Figure 9. Valves for reducing point of use temperature by mixing cold and hot water are also available:

Consult a Qualified Installer or Service Agency. Follow manufacturer's instructions for installation of the valves. Before changing the factory setting on the thermostat, read the Temperature Regulation section in this manual.

⚠ WARNING

Toxic Chemical Hazard

- Do not connect to non-potable water system.

This water heater shall not be connected to any heating systems or component(s) used with a non-potable water heating appliance.

All piping components connected to this unit for space heating applications shall be suitable for use with potable water.

Toxic chemicals, such as those used for boiler treatment shall not be introduced into this system.

When the system requires water for space heating at temperatures higher than required for domestic water purposes, a mixing valve must be installed. Please refer to Figure 9 for suggested piping arrangement.

These water heaters cannot be used in space heating applications only.

POWER SUPPLY

The water heaters covered in this manual require a 120 VAC, 1Ø (single phase), 60Hz, 5 amp power supply and must also be electrically grounded in accordance with local codes or, in the absence of local codes, with the National Electrical Code, ANSI/NFPA 70 or the Canadian Electrical Code, CSA C22.1.

If any of the original wire as supplied with the water heater must be replaced, it must be replaced with 105°C rated wiring or its equivalent, except in the burner housing. In this case 200°C rated wire must be used.

DEDICATED POWER WIRING AND BREAKERS

Dedicated power supply wires, ground wiring and dedicated circuit breakers often prevent electrical line noise and should be considered when installing the water heater.

POWER FLUCTUATIONS AND ELECTRICAL NOISE

The water heater's control system requires a source of stable clean electricity for proper operation. Connecting the water heater to a branch circuit that is subject to fluctuations in voltage level or electrical line noise such as EMI (electro magnetic interference) or RFI (radio frequency interference) may cause erratic control system operation and malfunction.

A high quality power supply filter/suppressor must be installed if the above conditions exist. Call the technical support phone number listed on the back cover of this manual for more information.

NOTE: Malfunctions caused by the power supply and the costs to install power supply filters are not covered under the limited warranty.

MIXING VALVES

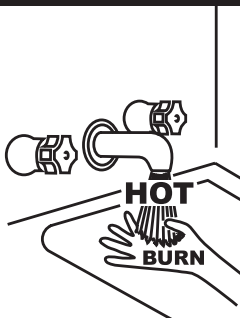

⚠ DANGER Water temperature over 125°F (52°C) can cause severe burns instantly resulting in severe injury or death.

Children, the elderly and the physically or mentally disabled are at highest risk for scald injury.

Feel water before bathing or showering.

Temperature limiting devices such as mixing valves must be installed when required by codes and to ensure safe temperatures at fixtures.

Water heated to a temperature which will satisfy clothes washing, dish washing, and other sanitizing needs can scald and cause permanent injury upon contact. Short repeated heating cycles caused by small hot water uses can cause temperatures at the point of use to exceed the water heater's temperature setting by up to 20°F (11°C).

Some people are more likely to be permanently injured by hot water than others. These include the elderly, children, the infirm and the physically/mentally disabled. Table 4 shows the approximate time-to-burn relationship for normal adult skin. If anyone using hot water provided by the water heater being installed fits into one of these groups or if there is a local code or state law requiring a certain water temperature at the point of use, then special precautions must be taken.

In addition to using the lowest possible temperature setting that satisfies the demand of the application a Mixing Valve should be installed at the water heater (see Figure 9) or at the hot water taps to further reduce system water temperature.

Mixing valves are available at plumbing supply stores. Consult a Qualified Installer or Service Agency. Follow mixing valve manufacturer's instructions for installation of the valves.

In all cases, the following burn table must be used.

Table 4

Water Temperature °F (°C)	Time for 1st Degree Burn (Less Severe Burns)	Time for Permanent Burns 2nd & 3rd Degree (Most Severe Burns)
110 (43.3)	(normal shower temp.)	
116 (46.7)	(pain threshold)	
116 (46.7)	35 minutes	45 minutes
122 (50)	1 minute	5 minutes
131 (55)	5 seconds	25 seconds
140 (60)	2 seconds	5 seconds
149 (65)	1 second	2 seconds
154 (67.8)	instantaneous	1 second

(U.S. Government Memorandum, C.P.S.C., Peter L. Armstrong, Sept. 15, 1978)

GAS PIPING

Make sure gas supplied is same type listed on model rating plate. The inlet gas pressure must not exceed 14 inch water column (3.5 kPa) for natural and propane gas (L.P.). The minimum inlet gas pressure shown on rating plate is that which will permit firing at rated input.

Schedule 40 Steel or Wrought Iron Pipe is the preferred material for the gas line of this water heater. It is imperative to follow the sizing recommendations in the latest version of the National Fuel Gas Code if Corrugated Stainless Steel Tubing (CSST) is used as the gas line for this water heater.

SEDIMENT TRAPS



⚠ WARNING

Fire and Explosion Hazard

- Contaminants in gas lines can cause fire or explosion.
- Clean all gas piping before installation.
- Install drip leg in accordance with NFPA54 or CAN/CSA-B149.1.

A sediment trap shall be installed as close to the gas inlet of the water heater as practical at the time of water heater installation. The sediment trap shall be either a tee fitting with a capped nipple in the bottom outlet or other device recognized as an effective sediment trap.

Contaminants in the gas lines may cause improper operation of the gas control valve that may result in fire or explosion. Before attaching the gas line be sure that all gas pipe is clean on the inside. To trap any dirt or foreign material in the gas supply line, a sediment trap must be incorporated in the piping. The sediment trap must be readily accessible. Install in accordance with the Gas Piping section. Refer to the current edition of the National Fuel Gas Code (ANSI Z223.1/NFPA 54) or the Natural Gas and Propane Installation Code (CAN/CSA B149.1)



⚠ WARNING

Fire and Explosion Hazard

- Use joint compound or tape compatible with propane.
- Leak test before operating heater.
- Disconnect gas piping and shut-off valve before pressure testing system.

Use pipe joint compound or teflon tape marked as being resistant to the action of petroleum [Propane (L.P.)] gases.

The water heater and its gas connection must be leak tested before placing the water heater in operation.

The water heater and its individual Shut-off valve shall be disconnected from the gas supply piping system during any pressure testing of that system at test pressures in excess of 1/2 pound per square inch (3.5 kPa). It shall be isolated from the gas supply piping system by closing its individual manual Shut-off valve during any pressure testing of the gas supply piping system at test pressures equal to or less than 1/2 pound per square inch (3.5 kPa).



⚠ WARNING

Fire and Explosion Hazard

- Do not use water heater with any gas other than the gas shown on the rating plate.
- Excessive pressure to gas control valve can cause serious injury or death.
- Turn off gas lines during installation.
- Contact qualified installer or service agency.

GAS SUPPLY SYSTEMS

Low pressure building gas supply systems are defined as those systems that cannot under any circumstances exceed 14" W.C. (1/2 PSI Gauge). These systems do not require pressure regulation. Measurements should be taken to insure that gas pressures are stable and fall within the requirements stated on the water heater rating plate. Readings should be taken with all gas burning equipment off (static pressure) and with all gas burning equipment running at maximum rate (dynamic pressure). The gas supply pressure must be stable within 1.5" W.C. from static to dynamic pressure to provide good performance. Pressure drops that exceed 1.5" W.C. may cause rough starting, noisy combustion or nuisance outages. Increases or spikes in static pressure during off cycles may cause failure to ignite or in severe cases damage to water heater gas control valves. If your low pressure system does NOT meet these requirements, the installer is responsible for the corrections.

High pressure building supply systems use pressures that exceed 14" W.C. (1/2 PSI Gauge). These systems must use field supplied regulators to lower the gas pressure to less than 14" W.C. (1/2 PSI Gauge). Appliances require gas regulators that are properly sized for the water heater input and deliver the rating plate specified pressures. Gas supply systems where pressure exceeds 5 PSI often require multiple regulators to achieve desired pressures. Systems in excess of 5 PSI building pressure should be designed by gas delivery professionals for best performance. Water heaters connected to gas supply systems that exceed 14" W.C. (1/2 PSI Gauge) at any time must be equipped with a gas supply regulator.

GAS PRESSURE REQUIREMENTS

All models require a minimum gas supply pressure of 3.5" W.C.(0.87 kPa) for natural gas and 8.0" W.C. (1.99 kPa) for propane. The minimum supply pressure is measured while gas is not flowing (static pressure) AND while gas is flowing (dynamic pressure). The supply pressure (static and dynamic) should never fall below 3.5" W.C.(0.87 kPa) for natural gas or 8.0" W.C. (1.99 kPa) for propane. The supply pressure should be measured with all gas fired water heaters connected to the common main firing at full capacity. If the supply pressure drops more than 1.5" W.C. (0.37 kPa) as gas begins to flow to the water heater then the supply gas system including the gas line and/or the gas regulator may be restricted or undersized. See Supply Gas Regulator section and Gas Piping section of this manual. The gas control valve on all models has a maximum gas supply pressure limit of 14" W.C.(3.48 kPa) The maximum supply pressure is measured while gas is not flowing (static pressure) AND while gas is flowing (dynamic pressure).

SUPPLY GAS REGULATOR

The maximum allowable gas supply pressure for this water heater is 14 inches W.C. (3.5 kPa). Install a positive lock-up gas pressure regulator in the gas supply line if inlet gas pressure can exceed 14 inches W.C. (3.5 kPa) at any time. Regulators must be sized/used according to manufacturer's specifications.

If a positive lock-up regulator is required follow these instructions:

1. Positive lock-up gas pressure regulators must be rated at or above the input Btu/hr rating of the water heater they supply.
2. Supply gas regulators shall have inlet and outlet connections not less than the minimum supply gas line size for the water heater they supply
3. Positive lock-up gas pressure regulator(s) should be installed no closer than 3 feet (1 meter) and no farther than 8 feet (2.4 meters) from the water heater's inlet gas connection.
4. After installing the positive lock-up gas pressure regulator(s) an initial nominal supply pressure setting of 7.0" W.C.(1.74 kPa) for Natural Gas and 11.0" W.C. (2.74 kPa) for Propane (LP) while the water heater is operating is recommended and will generally provide good water heater operation. Some additional adjustment may be required later to maintain a steady gas supply pressure.

5. When installing multiple water heaters in the same gas supply system it is recommended that individual positive lock-up gas pressure regulators be installed at each unit.

All gas piping must comply with local codes and ordinances or with the current editions National Fuel Gas Code (ANSI Z223.1/ NFPA-54) or the Natural Gas and Propane Installation Code (CAN/CSA B149.1) whichever applies. Copper or brass tubing and fittings (except tin lined copper tubing) shall not be used.

If the gas control valve is subjected to pressures exceeding 1/2 psi (3.5 kPa), the damage to the gas control valve could result in a fire or explosion from leaking gas.

If the main gas line Shut-off serving all gas water heaters is used, also turn off the gas at each water heater. Leave all gas appliances shut off until the water heater installation is complete.

A gas line of sufficient size must be run to the water heater. Consult the current edition of National Fuel Gas Code (ANSI Z223.1/NFPA 54) or the Natural Gas and Propane Installation Code (CAN/CSA B149.1) and your gas supplier concerning pipe size.

There must be:

- A readily accessible manual shut off valve in the gas supply line serving the water heater, and
- A sediment trap ahead of the gas control valve to help prevent dirt and foreign materials from entering the gas control valve.
- A ground joint union of proper size between the manual shut off valve and control valve to permit servicing of the unit.

Be sure to check all the gas piping for leaks before lighting the water heater. Use a soapy water solution, not a match or open flame. Rinse off soapy solution and wipe dry.

DISHWASHING MACHINES

All dishwashing machines meeting the National Sanitation Foundation requirements are designed to operate with water flow pressures between 15 and 25 pounds per square inch (103 kPa and 173 kPa). Flow pressures above 25 pounds per square inch (173 kPa), or below 15 pounds per square inch (103 kPa), will result in improperly sanitized dishes. Where pressures are high, a water pressure reducing or flow regulating control valve should be used in the 180°F (82°C) line to the dishwashing machine and should be adjusted to deliver water pressure between these limits.

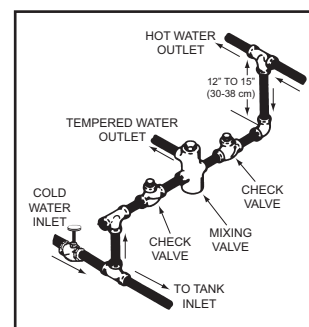

Figure 9

The National Sanitation Foundation also recommends circulation of 180°F (82°C) water. The circulation should be just enough to provide 180°F (82°C) water at the point of take-off to the dishwashing machine.

Adjust flow by throttling a full port ball valve installed in the circulating line on the outlet side of the pump. Never throttle flow on the suction side of a pump.

Note: To comply with NSF Standard 5 installation requirements the bottom of the water heater must be sealed to the floor with a silicone based sealant or elevated 6 inches above the floor.

SPACE HEATING AND POTABLE WATER SYSTEM

Your water heater is equipped with inlet/outlet connections for use in space heating applications (see Figure 10). If this water heater is to be used to supply both space heating and potable (drinking) water, the instructions listed below must be followed:

- Be sure to follow the manual(s) shipped with the air handler or other type heating system.
- This water heater cannot be used in space heating applications only.
- This water heater is not to be used as a replacement for an existing boiler installation.
- Do not use with piping that has been treated with chromates, boiler seal or other chemicals and do not add any chemicals to the water heater piping
- If the space heating system requires water temperatures in excess of 120°F, a mixing valve must be installed per the manufacturer's instructions in the potable hot water supply to limit the risk of scald injury.
- Pumps, valves, piping and fittings must be compatible with potable water.
- A properly installed flow control valve is required to prevent thermosiphoning. Thermosiphoning is the result of a continuous flow of water through the air handler circuit during the off cycle. Weeping (blow off) of the temperature and pressure relief valve (T & P relief valve) or higher than normal water temperatures are the first signs of thermosiphoning.
- The hot water line from the water heater should be vertical past any mixing valve or supply line to the heating system to remove air bubbles from the system. Do not connect the water heater to any system or components previously used with non-potable water heating appliances when used to supply potable water.

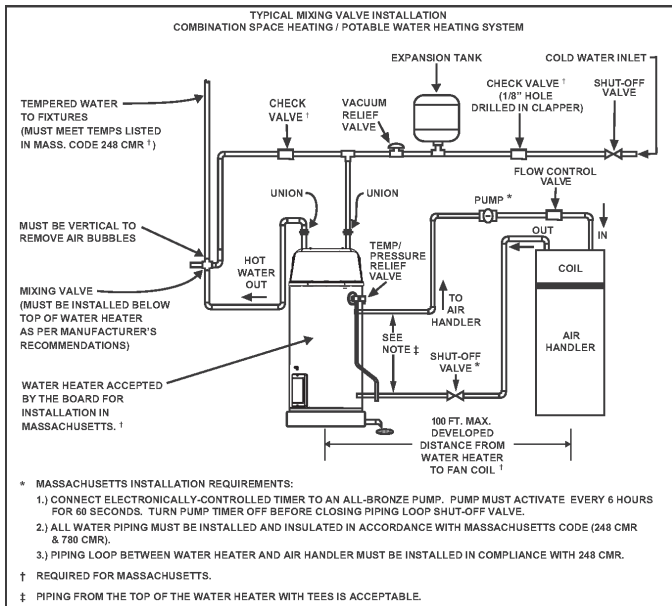

Figure 10

CLOSED WATER SYSTEMS

Water supply systems may, because of code requirements or such conditions as high line pressure, among others, have installed devices such as pressure reducing valves, check valves, and back flow preventers. Devices such as these cause the water system to be a closed system.

THERMAL EXPANSION

As water is heated, it expands (thermal expansion). In a closed system the volume of water will grow when it is heated. As the volume of water grows there will be a corresponding increase in water pressure due to thermal expansion. Thermal expansion can cause premature tank failure (leakage). This type of failure is not covered under the limited warranty. Thermal expansion can also cause intermittent temperature-pressure relief valve operation: water discharged from the valve due to excessive pressure build up. This condition is not covered under the limited warranty. The temperature-pressure relief valve is not intended for the constant relief of thermal expansion.

A properly sized thermal expansion tank should be installed on all closed systems to control the harmful effects of thermal expansion. Contact a local plumbing service agency to have a thermal expansion tank installed.

CAUTION	
Property Damage Hazard	
<ul style="list-style-type: none"> • Avoid water heater damage. • Install thermal expansion tank if necessary. • Do not apply heat to cold water inlet. • Contact qualified installer or service agency. 	

NOTE: To protect against untimely corrosion of hot and cold water fittings, it is strongly recommended that di-electric unions or couplings be installed on this water heater when connected to copper pipe, see Figure 11 also.

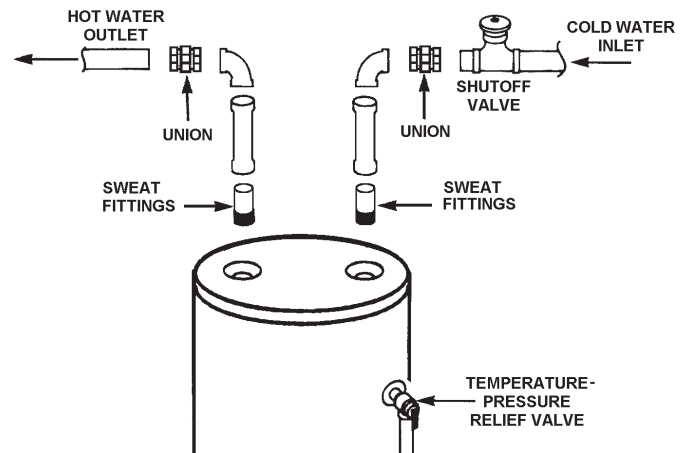

Figure 11

Figure 11 show the typical attachment of the water piping to the water heater. The water heater is equipped with 3/4 inch NPT water connections for 50 gallon unit and 1 inch NPT water connections for 75 gallon unit..

NOTE: If using copper tubing, solder tubing to an adapter before attaching the adapter to the water heater connections. Do not solder the water lines directly to the water heater connections. It will harm the dip tube and damage the tank, T & P Valve and Pipe Insulation (if supplied)

Fit pipe insulation over the incoming cold water line and the hot water line. Make sure that the insulation is against the top cover of the heater. Fit T & P valve insulation over valve. Make sure that the insulation does not interfere with the lever of the T & P valve.

Secure all insulation using tape.

TEMPERATURE-PRESSURE RELIEF VALVE

This water heater is provided with a properly rated/sized and certified combination Temperature-Pressure Relief Valve (T&P relief valve) by the manufacturer. The valve is certified by a nationally recognized testing laboratory that maintains periodic inspection of production of listed equipment of materials as meeting the requirements for Relief Valves for Hot Water Supply Systems, ANSI Z21.22 • CSA 4.4, and the code requirements of ASME.

If replaced, the new T&P valve must meet the requirements of local codes, but not less than a combination Temperature-Pressure Relief Valve rated/sized and certified as indicated in the above paragraph. The new valve must be marked with a maximum set pressure not to exceed the marked hydrostatic working pressure of the water heater (150 psi = 1,035 kPa) and a discharge capacity not less than the water heater Btu/hr or kW input rate as shown on the water heater's model rating plate.

NOTE: In addition to the factory installed Temperature-Pressure Relief Valve on the water heater, each remote storage tank that may be installed and piped to a water heating appliance must also have its own properly sized, rated and approved Temperature-Pressure Relief Valve installed.

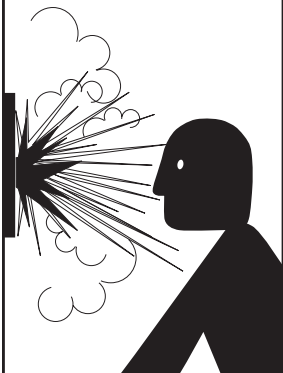
	<h3>! WARNING</h3> <h4>Explosion Hazard</h4>
	<ul style="list-style-type: none"> • Temperature-Pressure Relief Valve must comply with ANSI Z21.22- CSA 4.4 and ASME code. • Properly sized temperature-pressure relief valve must be installed in opening provided. • Can result in overheating and excessive tank pressure. • Can cause serious injury or death.

For safe operation of the water heater, the Temperature-Pressure Relief Valve must not be removed from its designated opening nor plugged. The Temperature-Pressure Relief Valve must be installed directly into the fitting of the water heater designed for the relief valve. Install discharge piping so that any discharge will exit the pipe within 6 inches (15.2 cm) above an adequate floor drain, or external to the building. In cold climates it is recommended that it be terminated at an adequate drain inside the building. Be certain that no contact is made with any live electrical part. The discharge opening must not be blocked or reduced in size under any circumstances. Excessive length, over 30 feet (9.14 m), or use of more than four elbows can cause restriction and reduce the discharge capacity of the valve.

No valve or other obstruction is to be placed between the Temperature-Pressure Relief Valve and the tank. Do not connect discharge piping directly to the drain unless a 6" (15.2 cm) air gap is provided. To prevent bodily injury, hazard to life, or property damage, the temperature-pressure relief valve must be allowed to discharge water in adequate quantities should circumstances demand. If the discharge pipe is not connected to a drain or other suitable means, the water flow may cause property damage.

<h3>CAUTION</h3> <h4>Water Damage Hazard</h4>
<ul style="list-style-type: none"> • Temperature-Pressure Relief Valve discharge pipe must terminate at adequate drain.

T&P VALVE DISCHARGE PIPE REQUIREMENTS:

- Shall not be smaller in size than the outlet pipe size of the valve, or have any reducing couplings or other restrictions.
- Shall not be plugged or blocked.
- Shall not be exposed to freezing temperatures.
- Shall be of material listed for hot water distribution.
- Shall be installed so as to allow complete drainage of both the Temperature-Pressure Relief Valve and the discharge pipe.
- Must terminate a maximum of six inches (15.2 cm) above a floor drain or external to the building. In cold climates, it is recommended that the discharge pipe be terminated at an adequate drain inside the building.
- Shall not have any valve or other obstruction between the temperature-pressure relief valve and the drain.

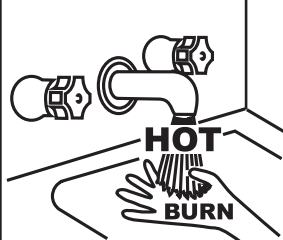
<h3>! DANGER</h3> 	<ul style="list-style-type: none"> • Burn hazard. • Hot water discharge. • Keep clear of Temperature-Pressure Relief Valve discharge outlet.
--	---

The Temperature-Pressure Relief Valve must be manually operated at least twice a year. Caution should be taken to ensure that (1) no one is in front of or around the outlet of the Temperature-Pressure Relief Valve discharge line, and (2) the water manually discharged will not cause any bodily injury or property damage because the water may be extremely hot. If after manually operating the valve, it fails to completely reset and continues to release water, immediately close the cold water inlet to the water heater, follow the draining instructions in this manual, and replace the Temperature-Pressure Relief Valve with a properly rated/sized new one.

NOTE: The purpose of a Temperature-Pressure Relief Valve is to prevent excessive temperatures and pressures in the storage tank. The T&P valve is not intended for the constant relief of thermal expansion. A properly sized thermal expansion tank must be installed on all closed systems to control thermal expansion, see Closed Water Systems and Thermal Expansion on Page 21.

If you do not understand these instructions or have any questions regarding the Temperature-Pressure Relief Valve call the toll free number listed on the back cover of this manual for technical assistance.

CONDENSATE PIPING

The water heaters covered in this manual are condensing appliances and require a building drain to be located in close proximity to allow the condensate to drain safely.

Condensate drains from the water heater at the exhaust elbow located at the bottom. The field installed condensate drain line must not be elevated above the condensate drain connection on the condensate trap, see Figure 12. If the condensate does not drain properly it will build up in the exhaust (vent) elbow. This will restrict the flow of flue gases and cause the Blocked Exhaust pressure switch to open its contacts. The control system monitors all pressure switches, if the Blocked Exhaust Switch contacts are open the control system will lock out and disable heating operation. The "Blocked Exhaust" Fault message will be displayed on the control system's LCD.

The Condensate Cleanout Cap must be on and tight when unit is in operation.

NOTE: If the "Blocked Exhaust " Fault message is ever displayed on the control system LCD, check the condensate drain first and ensure it is not blocked.

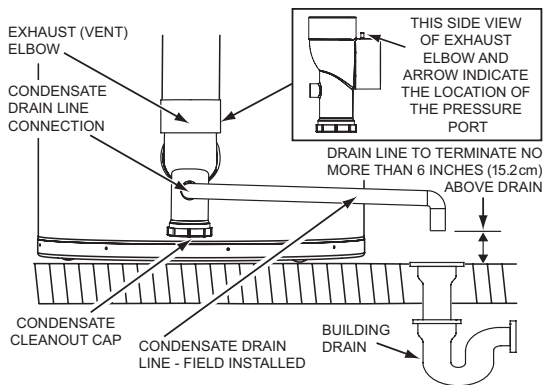

Figure 12

DO NOT remove the factory installed exhaust/condensate elbow for any reason, see Figure 12. The water heater's vent pipe is under a slight positive pressure while unit is in operation. The water trap inside of the exhaust/condensate elbow prevents flue gases from escaping into the installed space.

Do not install any external condensate trap. The exhaust elbow assembly has an internal condensate trap.

CONDENSATE DRAIN INSTALLATION

Installation must conform with these instructions and local building codes.

Field supplied materials required for installation include:

- Approved PVC cement and PVC primer.
- 1/2 inch PVC pipe - minimum length to equal the distance between the water heater and a suitable building drain.
- 1/2 inch PVC fittings (elbows, couplings, and adapters) necessary to install a condensate drain line between the Exhaust/Condensate Elbow Assembly and a suitable building drain.
- Floor mounted standoffs to brace the drain line.

INSTALLATION NOTES

1. The condensate drains from the water heater's covered by this instruction have PH levels between 4.3 and 5.0. Install a commercially available neutralizing kit if required by local codes. Lower PH levels are acidic. Do not connect a metal condensate drain line, such as copper pipe, to the water heater for this reason.
2. The field installed condensate drain line must not be less than 1/2 inch PVC in size.
3. **DO NOT** remove, modify or alter the factory condensate trap.

INSTALLATION INSTRUCTIONS

1. Ensure the water heater's enable/disable switch is in the "disable" position.
2. Install a 1/2 inch PVC condensate drain line between condensate drain connection on the Exhaust/Condensate Elbow and a suitable building drain with a slight downward slope to drain. The exhaust elbow has a "built in" condensate trap. Do not install an additional trap in the condensate drain piping. See Figure 12.
3. Terminate the condensate drain piping with an elbow above the drain. Ensure that any discharge will exit the condensate drain line no more than 6 inches (15.2 cm) above a suitable building drain, or external to the building, see Figure 12.

NOTE: In cold climates it is recommended the condensate drain be terminated at a suitable drain inside the building.

4. Ensure the condensate drain line is not elevated above the condensate drain connection on the Exhaust/Condensate Elbow, see Figure 12.
5. Brace the condensate drain line with floor mounted standoffs every three feet.
6. Ensure the condensate drains freely during start up and the condensate clean out cap is on and tight when unit is in operation.

7. Condensate clean out cap must be on and tight when unit is in operation.

HIGH ALTITUDE INSTALLATIONS

⚠ WARNING	
Breathing Hazard - Carbon Monoxide Gas	
	<ul style="list-style-type: none"> • Special consideration must be taken with installations above 10,100 feet (3,078 m). • Please contact an AO Smith qualified service agent to obtain the proper setup and instructions before lighting. • Failure to implement the proper setup will result in improper and inefficient operation of the appliance resulting in production of increased levels of carbon monoxide gas in excess of the safe limits which could result in serious personal injury or death.
<p>Breathing carbon monoxide can cause brain damage or death. Always read and understand instruction manual.</p>	

This high efficiency water heater is certified for use without modification for an altitude of 10,100 feet (3,078 m). Consult the factory for installation at altitudes over 10,100 feet (3,078 m).

Some gas utility companies derate their gas for altitude, making it unnecessary to install high altitude orifices. Call the local gas or utility company to verify BTU content.

Due to the input rate reduction at high altitudes, the output rating of the water heater is also reduced and should be compensated for in the sizing of the equipment for applications.

FILLING THE WATER HEATER

CAUTION	
Property Damage Hazard	
<ul style="list-style-type: none"> • Avoid water heater damage. • Fill tank with water before operating. 	

Never use this water heater unless it is completely full of water. To prevent damage to the tank, the tank must be filled with water. Water must flow from the hot water faucet before turning ON gas to the water heater.

To fill the water heater with water:

1. Close the water heater drain valve by turning the handle to the right (clockwise). The drain valve is on the lower front of the water heater.
2. Open the cold water supply valve to the water heater. **NOTE:** The cold water supply valve must be left open when the water heater is in use.
3. To insure complete filling of the tank, allow air to exit by opening the nearest hot water faucet. Allow water to run until a constant flow is obtained. This will let air out of the water heater and the piping.
4. Check all water piping and connections for leaks. Repair as needed.

INSTALLATION REQUIREMENTS FOR THE COMMONWEALTH OF MASSACHUSETTS

For all side wall terminated, horizontally vented power vent, direct vent, and power direct vent gas fueled water heaters installed in every dwelling, building or structure used in whole or in part for residential purposes, including those owned or operated by the Commonwealth and where the side wall exhaust vent termination is less than seven (7) feet above finished grade in the area of the venting, including but not limited to decks and porches, the following requirements should be satisfied:

INSTALLATION OF CARBON MONOXIDE DETECTORS At the time of installation of the side wall horizontal vented gas fueled equipment, the installing plumber or gasfitter should observe that a hard wired carbon monoxide detector with an alarm and battery back-up is installed on the floor level where the gas equipment is to be installed. In addition, the installing plumber or gasfitter should observe that a battery operated or hard wired carbon monoxide detector with an alarm is installed on each additional level of the dwelling, building or structure served by the sidewall horizontal vented gas fueled equipment. It should be the responsibility of the property owner to secure the services of qualified licensed professionals for the installation of hard wired carbon monoxide detectors.

In the event that the side wall horizontally vented gas fueled equipment is installed in a crawl space or an attic, the hard wired carbon monoxide detector with alarm and battery back-up may be installed on the next adjacent floor level.

In the event that the requirements of this subdivision can not be met at the time of completion of installation, the owner should have a period of thirty (30) days to comply with the above requirements provided that during said thirty (30) day period, a battery operated carbon monoxide detector with an alarm should be installed.

APPROVED CARBON MONOXIDE DETECTORS Each carbon monoxide detector as required in accordance with the above provisions should comply with NFPA 720 and be ANSI/UL 2034 listed and CSA certified.

SIGNAGE A metal or plastic identification plate should be permanently mounted to the exterior of the building at a minimum height of eight (8) feet above grade directly in line with the exhaust vent terminal for the horizontally vented gas fueled heating appliance or equipment. The sign should read, in print size no less than one-half (1/2) inch in size, **GAS VENT DIRECTLY BELOW. KEEP CLEAR OF ALL OBSTRUCTIONS.**

INSPECTION The state or local gas inspector of the side wall horizontally vented gas fueled equipment should not approve the installation unless, upon inspection, the inspector observes carbon monoxide detectors and signage installed in accordance with the provisions of 248 CMR 5.08(2)(a) 1 through 4.

EXEMPTIONS: The following equipment is exempt from 248 CMR 5.08(2)(a)1 through 4:

1. The equipment listed in Chapter 10 entitled Equipment Not Required To Be Vented in the most current edition of NFPA 54 as adopted by the Board; and
2. Product Approved side wall horizontally vented gas fueled equipment installed in a room or structure separate from the dwelling, building, or structure used in whole or in part for residential purposes.

MANUFACTURER REQUIREMENTS - GAS EQUIPMENT VENTING SYSTEM PROVIDED When the manufacturer of Product Approved side wall horizontally vented gas equipment provides a venting system design or venting system components with the equipment, the instructions provided by the manufacturer for installation of the equipment and the venting system should include:

1. Detailed instructions for the installation of the venting system design or the venting system components; and
2. A complete parts list for the venting system design or venting system.

MANUFACTURER REQUIREMENTS - GAS EQUIPMENT VENTING SYSTEM NOT PROVIDED When the manufacturer of a Product Approved side wall horizontally vented gas fueled equipment does not provide the parts for venting the flue gases, but identifies special venting systems, the following requirements should be satisfied by the manufacturer:

1. The referenced special venting system instructions should be included with the appliance or equipment installation instructions; and
2. The special venting systems should be Product Approved by the Board, and the instructions for that system should include a parts list and detailed installation instructions.

A copy of all installation instructions for all Product Approved side wall horizontally vented gas fueled equipment, all venting instructions, all parts lists for venting instructions, and/or all venting design instructions should remain with the appliance or equipment at the completion of the installation.

VENTING INSTALLATION

⚠ WARNING

Breathing Hazard - Carbon Monoxide Gas



- Install vent system in accordance with these instructions and local codes.
- Do not operate water heater if flood damaged.
- Do not operate if soot buildup.
- Do not obstruct water heater air intake with insulating jacket.
- Do not place chemical vapor emitting products near water heater.
- Gas and carbon monoxide detectors are available.
- Never operate the heater unless it is vented to the outdoors and has adequate air supply to avoid risks of improper operation, fire, explosion or asphyxiation.
- Analyze the entire vent system to make sure that condensate will not become trapped in a section of vent pipe and therefore reduce the open cross sectional area of the vent.

Breathing carbon monoxide can cause brain damage or death.
Always read and understand instruction manual.

VENT INSTALLATION CONSIDERATIONS

This water heater can be vented using room air for intake combustion air, or direct vented so that all intake air for combustion comes from the outside through a sealed pipe.

This water heater may be installed in 4 separate orientations depending on the requirements of the building and the water heater. The installer must decide which method is most appropriate for each installation. These orientations are:

1. Vertical Termination - vertical vent termination through unenclosed or enclosed areas with roof penetration, refer to Vertical Vent Terminal Installation on Page 31.
2. Through-the-Wall Termination - horizontal vent termination directly through an outside wall, see Figure 13 on Page 27.
3. Horizontal Direct Vent - using Through-the-Wall Termination to exhaust flue products and piping to bring combustion air to the water heater from the outside. See Figure 15 on Page 28 and Figure 23 and Figure 24 on page 32.
4. Vertical Direct Vent - using a vertical vent termination to exhaust flue products and piping to bring combustion air to the water heater from outside, see Figure 21 & Figure 22 on Page 32.

In cold climates any water vapor remaining in the flue gases will condense into a cloud of vapor at the point where the vent system exits the building. Special consideration is recommended, before locating the vent termination near walkways, windows and building entrances.

Direct venting into dead spaces such as alleys, atriums, and inside corners can cause recirculation of flue gases. Recirculation of flue gases will cause sooting, and icing of the combustion air intake during severe cold weather. To prevent the recirculation of flue gases, maintain as much distance as possible between the combustion air intake and the exhaust vent terminal refer to Figure 16 and Figure 17 on Page 29 & Page 30 respectively.

APPROVED VENT/INTAKE MATERIAL

Approved vent and intake air pipe materials that may be used in the United States:

PVC pipe materials:

- DWV ASTM-D2665 or CSA B181.2
- Schedule 40, 80, 120 ASTM-D1785 or CSA B137.3
- SDR Series ASTM-2241 or CSA B137.3

CPVC pipe materials:

- CPVC 41 ASTM-D2846 or CSA B137.6
- Schedule 40, 80 ASTM-F441 or CSA B137.6
- SDR Series ASTM-F442

Polypropylene - See page 26

- M & G Duravent PolyPro vent system
- Centrotherm InnoFlue vent system

Approved vent pipe materials that must be used in Canada:

- ULC S636 PVC / CPVC
- ULC S636 Polypropylene - See page 26

Approved intake air pipe materials that must be used in Canada:

PVC pipe materials:

- DWV ASTM-D2665 or CSA B181.2
- Schedule 40, 80, 120 ASTM-D1785 or CSA B137.3
- SDR Series ASTM-D2241 or CSA B137.3

CPVC pipe materials:

- CPVC 41 ASTM-D2846 or CSA B137.6
- Schedule 40, 80 ASTM-F441 or CSA B137.6
- SDR Series ASTM-F442

Polypropylene - See page 26

- M & G Duravent PolyPro vent system
- Centrotherm InnoFlue vent system

NOTE:

The use of cellular core PVC (ASTM F891), cellular core CPVC, or Radel® (polyphenolsulfone) in non-metallic venting systems is prohibited. Covering non-metallic vent pipe and fittings with thermal insulation is prohibited.

If the water heater is being installed as a replacement for an existing power vented heater in pre-existing venting, a thorough inspection of existing venting system must be performed prior to any installation work. Verify that correct material as detailed above has been used, and that the minimum or maximum vent lengths and terminal location as detailed in this manual have been met. Carefully inspect the entire venting system for any signs of cracks or fractures, particularly at joints between elbows and other fittings and straight runs of vent pipe. Check system for signs of sagging or other stresses in joints as a result of misalignment of any components in the system. If any of these conditions are found, they must be corrected in accordance with the venting instructions in this manual before completing installation and putting the water heater into service.

NOTE: For water heaters in locations with high ambient temperatures above 100°F (38°C) it is recommended that CPVC or Polypropylene pipe and fittings be used.

All vent (exhaust) pipes must be pitched a minimum of a 1/4" per foot back to the water heater to allow drainage of condensation.

Never operate the water heater unless it is vented to the outdoors.

The instructions in this section of the manual must be followed to avoid choked combustion or recirculation of flue gases. Such conditions cause sooting of the combustion chamber, burners and flue tubes and creates a risk of asphyxiation.

For direct vent application where combustion air might be supplied from extremely cold ambient through fresh air intake piping system, it is recommended that a backflow preventer be installed at the intake vent terminal close to the blower before proceeding with installation of the rest of the fresh air intake piping. Call the technical support phone number listed on the back cover of this manual for more information.

POLYPROPYLENE INSTALLATIONS

The water heater has been approved to be installed with Polypropylene vent material as shown in Table 5 and Table 6. The approved application of single wall, non-flexible, non-concentric Polypropylene vent material is offered by two specific manufacturers (Centrotherm ECO Systems and DuraVent Polypropylene). These listed products must be installed by following the vent manufacturer's instructions. Refer to Table 7 on Page 27 to determine the maximum pipe length and number of elbows that can be used.

Insulation should not be used on Polypropylene venting materials. The use of insulation will cause increased vent wall temperatures, which could result in vent pipe failure.

Use only the adapters and vent system listed in Tables below. DO NOT mix vent systems of different types or manufacturers. Failure to comply could result in severe personal injury, death, or substantial property damage.

Installations must comply with applicable national, state, and local codes. For Canadian installation, Polypropylene vent must be listed as a ULC-S636 approved system. If Polypropylene vent is not required by your local code, you may use either PVC or CPVC pipes for your water heater that allows non-metallic venting material installations.

Polypropylene vent systems do not use cement to connect the pipe and elbow sections but use a push together gasket seal method. Do not attempt to connect Polypropylene with sealant cement. All vent connections MUST be secured by the vent manufacturer's joint connector. The installer must use a specific vent starter adapter at the flue connection. The adapter is supplied by the vent manufacturer to adapt to its vent system.

In order to be in full compliance with UL 1738 or ULC-S636 and to meet the requirements of the water heater manufacturer, you must use the metal joint connector rings, available from the Polypropylene vent manufacturer, to stiffen the joints of 2", and 3" diameter pipes.

Table 5

M & G DuraVent PolyPro						
Nominal Pipe Diameter	Flue Outlet Adapter	Adapter Connector	Ring Connector	90 Degree Elbow	Vent Material	Terminal(s)
2"	2PPS-AD	PPS-PAC	2PPS-LB	2PPS-E90	2PPS	2PPS & 2PPS-BG for Exhaust; 2PPS-E90 & 2PPS-BG for Intake (Direct Vent only)
3"	3PPS-AD	PPS-PAC	3PPS-LB	3PPS-E90	3PPS	3PPS & 3PPS-BG for Exhaust; 3PPS-E90 & 3PPS-BG for Intake (Direct Vent only)

Table 6

Centrotherm InnoFlue SW						
Nominal Pipe Diameter	Flue Outlet Adapter	Adapter Connector	Ring Connector	90 Degree Elbow	Vent Material	Terminal(s)
2"	ISAGL 0202	IAFC02	IANS02	ISELL0287	ISVL02	ISVL02 & IASPP02 for Exhaust; ISELL0287 & IASPP02 for Intake (Direct Vent only)
3"	ISAGL 0303	IAFC03	IANS03	ISELL0387	ISVL03	ISVL03 & IASPP03 for Exhaust; ISELL0387 & IASPP03 for Intake (Direct Vent only)

VENT PIPE TERMINATION

The first step is to determine where the vent pipe will terminate. See Figure 13, Figure 14A, and Figure 15. The vent may terminate through a sidewall as shown in Figure 13, Figure 14A and Figure 15 or through the roof as shown in Figure 18, Figure 19 and Figure 20.

The vent system must terminate so that proper clearances are maintained as cited in local codes or the current edition of the National Fuel Gas Code, (ANSI Z223.1, 12.9.1 through 12.9.4) or the Natural Gas and Propane Installation Code (CAN/CSA-B149.1). See Figure 16 and Figure 17.

Instructions on proper installation through a sidewall are provided in Figure 13, Figure 14A, and Figure 15.

Plan the vent system layout so that proper clearances are maintained from plumbing and wiring.

Vent pipes serving power vented water heaters are classified by building codes as vent connectors. Required clearances from combustible materials must be provided in accordance with information in this manual under Locating The Water Heater and Installation Requirements, and with the National Fuel Gas Code and local codes.

PLANNING THE VENT SYSTEM

Plan the route of the vent system from the exhaust elbow to the planned location of the vent terminal.

1. Layout total vent system to use a minimum of vent pipe and elbows.
2. This water heater is capable of venting flue gases in equivalent feet of pipe as listed in Table 7.

Table 7

Number of 90° Elbows	2" Maximum Pipe - ft. (m)	3" Maximum Pipe - ft. (m)
1	40 (12.19)	120 (36.57)
2	35 (10.66)	115 (35.05)
3	30 (9.14)	110 (33.52)
4	25 (7.62)	105 (32)
5	20 (6.09)	100 (30.48)
6	15 (4.57)	95 (28.95)

The minimum vent length for each of the pipe size is one 90° elbow plus 2' and 7' (0.61 m and 2.1 m) of straight pipe for air intake and exhaust vent respectively and the appropriate termination.

NOTE: The equivalent feet (m) of pipe listed above are exclusive of the termination. That is, the termination, with an installed screen, is assumed to be in the system and the remainder of the system must not exceed the lengths and number of elbows shown in Table 7.

If using 2" inch vent pipe: A 2" diameter vent pipe must be inserted and fastened to the exhaust elbow assembly.

If using 3" inch vent pipe: Two inches (5.1cm) of 2" diameter pipe must be inserted and fastened to the exhaust elbow assembly before adding a 2' x 3" reducer to acquire the desired pipe diameter. A 3" coupling (supplied locally-a schedule 40 DWV) vent terminal must be obtained. A 3" diameter screen is supplied in the vent kit.

INSTALLATION OF HORIZONTAL THROUGH THE WALL VENT SYSTEM

If you are installing your system so that it vents through roof, please refer to section titled VERTICAL VENT TERMINAL INSTALLATION.

VENT TERMINAL INSTALLATION, SIDEWALL

1. Install the vent terminal by using the cover plate as a template to mark the hole for the vent pipe to pass through the wall. BEWARE OF CONCEALED WIRING AND PIPING INSIDE THE WALL.
2. If the Vent Terminal is being installed on the outside of a finished wall, it may be easier to mark both the inside and outside wall. Align the holes by drilling a hole through the center of the template from the inside through to the outside. The template can now be positioned on the outside wall using the drilled hole as a centering point for the template.

3. A) MASONRY SIDE WALLS

Chisel an opening approximately one half inch (1.3 cm) larger than the marked circle.

B) WOODEN SIDE WALLS

Drill a pilot hole approximately one quarter inch (0.64 cm) outside of the marked circle. This pilot hole is used as a starting point for a saws-all or sabre saw blade. Cut around the marked circle staying approximately one quarter inch (0.64 cm) outside of the line. (This will allow the vent to easily slide through the opening. The resulting gap will be covered up by the Vent Terminal wall plate.) Repeat this step on inside wall if necessary.

Cut a length of pipe about 3.5 inches (8.9 cm) longer than the wall thickness at the opening. Glue the vent terminal to this section of pipe. Slide the wall plate over the pipe to stop against the vent terminal. Place a bead of caulking (not supplied) around the gap between the pipe and cover plate. Apply enough to fill some of the gap between the pipe and wall. Place some of the caulking on the back of the plate to hold it against the wall after installation. If the vent pipe is installed up to the wall, with a coupling on the end against the wall opening, the pipe with the vent terminal can be prepared for gluing before inserting through the wall. Slide the pipe through the wall and insert into the coupling on the other side of the wall, making sure that the vent terminal ends up pointed in the correct position, see Figure 13.

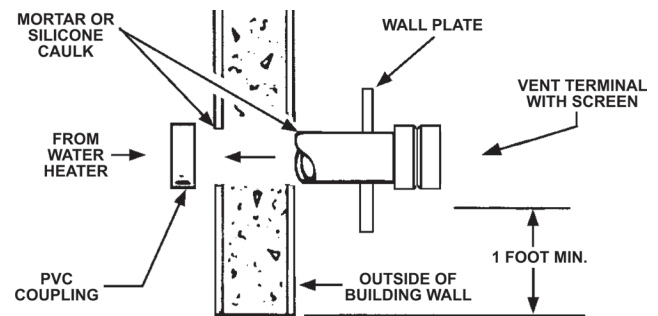

Figure 13: VENT TERMINATION

DIRECT VENT TERMINAL INSTALLATION

The air intake provided on the unit contains an air intake screen to prevent large particles from entering the unit.

Blower Air Inlet Assembly



Figure 14: Air Intake Screen

When the unit is to be set up as a direct vent, the air intake screen must be removed. The air intake pipe may then be glued to the air intake (see Figure 14) provided on the unit.

This unit consists of two terminals - an air intake terminal and an exhaust vent terminal. The air intake terminal is a 2" 90° pvc elbow with an air intake screen and the exhaust vent terminal is a 2" straight pvc coupling with a mesh wire screen.

Note: to prevent exhausting products from circulating to the air intake in windy/cold areas, the maximum practical distance between these two terminals is recommended.

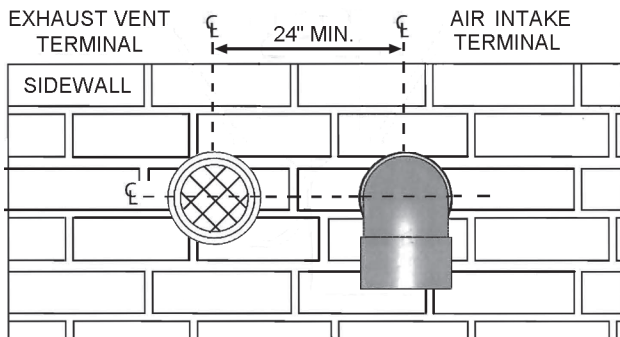
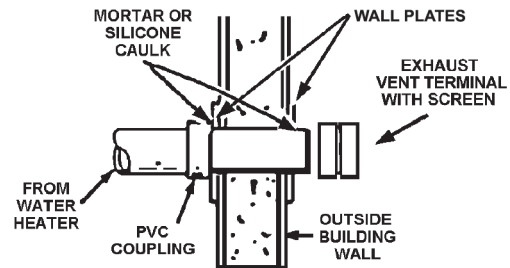

Figure 14A

B.) WOODEN SIDE WALLS Drill a pilot hole approximately one quarter inch outside of the marked circle. This pilot hole is used as a starting point for a saws-all or sabre saw blade. Cut around the marked circle staying approximately one quarter inch outside of the line. (This will allow the vent pipe to easily slide through the opening. The resulting gap will be covered by the vent terminal cover plates.) Repeat this step on the inside wall if necessary.

2. Cut a length of pipe about 3.5" (8.9 cm) longer than the wall thickness at the opening.
3. Glue the air intake terminal to the section of the pipe.
4. Slide the wall plate over pipe to stop against air intake terminal.
5. Place a bead of caulking (not supplied) around the gap between the pipe and the wall. Place some of the caulking on the back of the plate to hold it against the wall after installation.
6. If the air intake pipe is installed up to the wall, with a coupling on the end against the wall opening, the pipe with the air intake terminal can be prepared for gluing before inserting through the wall. Slide the pipe through the wall and insert into coupling on the other side of the wall, making sure that the air intake terminal ends up pointed in the correct position (Figure 14A and Figure 15).



EXHAUST VENT TERMINAL - ALL MODELS

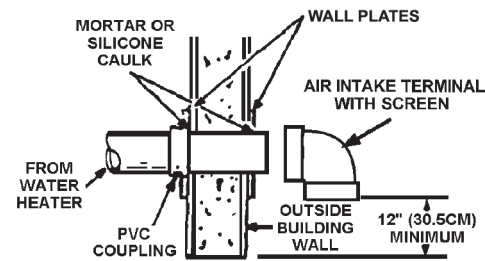

AIR INTAKE TERMINAL - ALL MODELS

Figure 15

INSTALLATION SEQUENCE

1. After the points of termination have been determined, use the cover plates as templates to mark the holes for the vent pipes to be inserted through the wall. BEWARE OF CONCEALED WIRING AND PIPING INSIDE OF WALL. If the vent terminals are being installed on the outside of a finished wall, it may be easier to mark both the inside and outside wall. Align the holes by drilling a hole through the center of the template from the inside through to the outside. The template can now be positioned on the outside wall using the drilled holes as a centering point for the template.

A.) MASONRY SIDE WALLS Chisel an opening approximately 1/2" (1.3 cm) larger than the marked circle.

TERMINATION CLEARANCES SIDEWALL POWER VENT

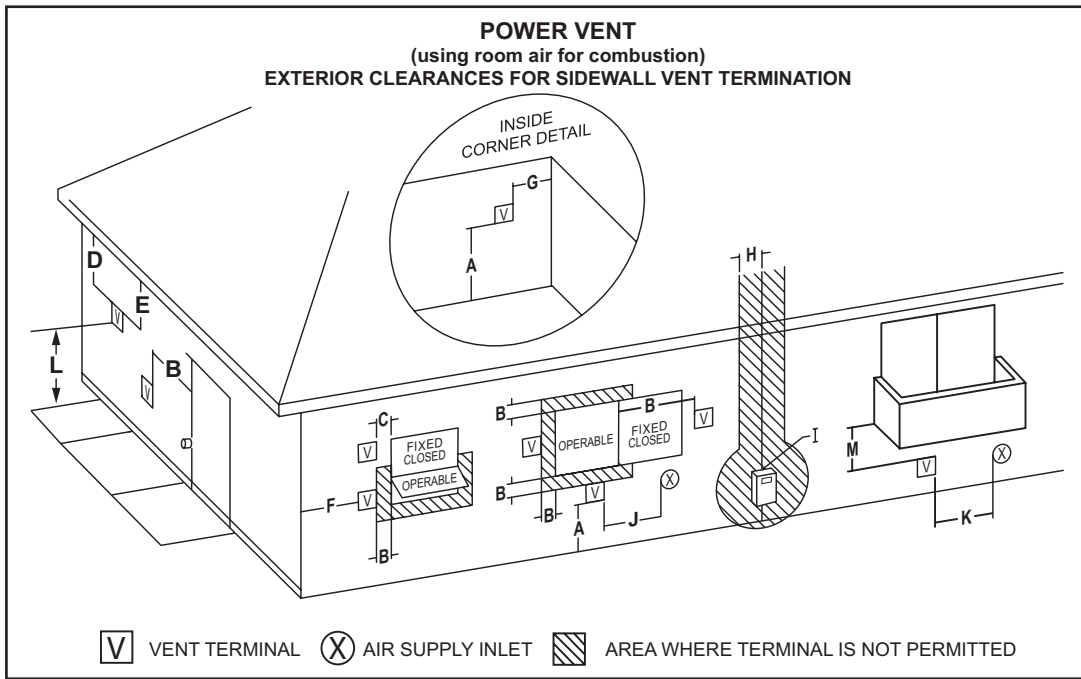

Figure 16

Vent terminal clearances for “Power Vent” installations. Power Vent configurations use room air for combustion.

	CANADIAN INSTALLATIONS ¹		US INSTALLATIONS ²		CANADIAN INSTALLATIONS ¹		US INSTALLATIONS ²	
A	Clearance above grade, veranda, porch, deck or balcony	12 inches (30 cm)	12 inches (30 cm)	H	Clearance to each side of center line extended above meter/regulator assembly	3 feet (91 cm) within a height 15 feet (4.5 m) above the meter/regulator assembly	3 feet (91 cm) within a height 15 feet (4.5 m) above the meter/regulator assembly*	
B	Clearance to window or door that may be opened	6 inches (15 cm) for appliances up to 10,000 Btu/hr (3 kW), 12 inches (30 cm) for appliances between 10,000 Btu/hr (3 kW) and 100,000 Btu/hr (30 kW), 36 inches (91 cm) for appliances above 100,000 Btu/hr (30 kW)	4 feet (1.2 m) below or to side of opening; 1 foot (30 cm) above opening	I	Clearance to service regulator vent outlet	3 feet (91 cm)	3 feet (91 cm)*	
C	Clearance to permanently closed window	*	12 inches (30 cm)*	J	Clearance to a non mechanical air supply inlet into building or combustion air inlet to any other appliance	6 inches (15 cm) for appliances up to 10,000 Btu/hr (3 kW), 12 inches (30 cm) for appliances between 10,000 Btu/hr (3 kW) and 100,000 Btu/hr (30kW), 36 inches (91cm) for appliances above 100,000 Btu/hr (30 kW)	4 feet (1.2 m) below or to side of opening; 1 foot (30 cm) above opening.	
D	Vertical clearance to ventilated soffit located above the terminal within a horizontal distance of 2 feet (61 cm) from the center line of the terminal	*	12 inches (30 cm)*	K	Clearance to a mechanical air supply inlet	6 feet (1.83 m)	3 feet (91 cm) above if within 10 feet (3 m) horizontally	
E	Clearance to unventilated soffit	*	12 inches (30 cm)*	L	Clearance above paved sidewalk or paved driveway located on public property	7 feet (2.13 m)†	7 feet (2.13 m)	
F	Clearance to outside corner	2 feet (60 cm)*	2 feet (60 cm)*	M	Clearance under veranda, porch, deck, or balcony	12 inches (30 cm) ‡	12 inches (30 cm) ‡	
G	Clearance to inside corner	18 inches (45 cm)*	18 inches (45 cm)*					

¹ In accordance with the current CSA B149.1, Natural Gas and Propane Installation Code.

² In accordance with the current ANSI Z223.1/NFPA 54, National Fuel Gas Code.

† A vent shall not terminate where it may cause hazardous frost or ice accumulations on adjacent property surfaces.

‡ Permitted only if veranda, porch, deck, or balcony is fully open on a minimum of two sides beneath the floor.

* Clearance in accordance with local installation codes and the requirements of the gas supplier and the manufacturer's installation instructions.

TERMINATION CLEARANCES SIDEWALL DIRECT VENT

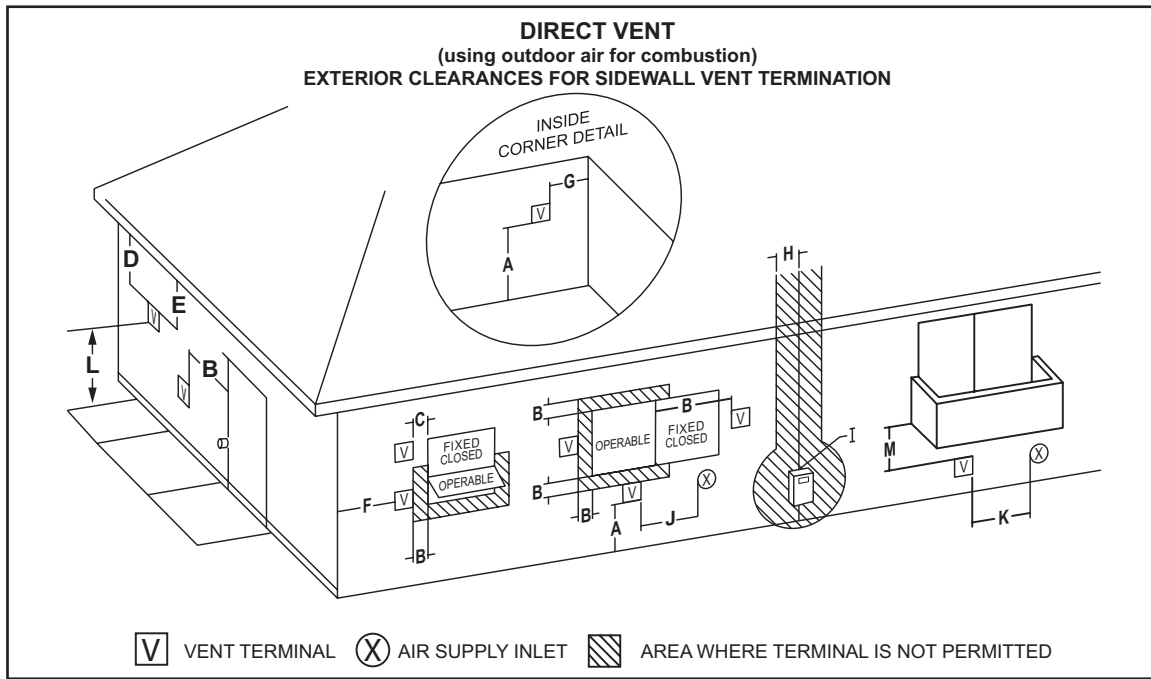

Figure 17

Vent terminal clearances for “Direct Vent” installations. Direct Vent configurations use outdoor air for combustion.

		CANADIAN INSTALLATIONS ¹		US INSTALLATIONS ²		CANADIAN INSTALLATIONS ¹		US INSTALLATIONS ²	
A	Clearance above grade, veranda, porch, deck or balcony	12 inches (30 cm)	12 inches (30 cm)	H	Clearance to each side of center line extended above meter/regulator assembly	3 feet (91 cm) within a height 15 feet (4.5 m) above the meter/regulator assembly	3 feet (91 cm) within a height 15 feet (4.5 m) above the meter/regulator assembly*		
B	Clearance to window or door that may be opened	6 inches (15 cm) for appliances up to 10,000 Btu/hr (3 kW), 12 inches (30 cm) for appliances between 10,000 Btu/hr (3 kW) and 100,000 Btu/hr (30 kW), 36 inches (91 cm) for appliances above 100,000 Btu/hr (30 kW)	6 inches (15 cm) for appliances up to 10,000 Btu/hr (3 kW), 9 inches (23 cm) for appliances between 10,000 Btu/hr (3 kW) and 50,000 Btu/hr (15 kW), 12 inches (30 cm) for appliances above 50,000 Btu/hr (15 kW)	I	Clearance to service regulator vent outlet	3 feet (91 cm)	3 feet (91 cm)*		
C	Clearance to permanently closed window	*	6 inches (15 cm)*	J	Clearance to a non mechanical air supply inlet into building or combustion air inlet to any other appliance	6 inches (15 cm) for appliances up to 10,000 Btu/hr (3 kW), 12 inches (30 cm) for appliances between 10,000 Btu/hr (3 kW) and 100,000 Btu/hr (30 kW), 36 inches (91 cm) for appliances above 100,000 Btu/hr (30 kW)	6 inches (15 cm) for appliances up to 10,000 Btu/hr (3 kW), 9 inches (23 cm) for appliances between 10,000 Btu/hr (3 kW) and 50,000 Btu/hr (15 kW), 12 inches (30 cm) for appliances above 50,000 Btu/hr (15 kW)		
D	Vertical clearance to ventilated soffit located above the terminal within a horizontal distance of 2 feet (61 cm) from the center line of the terminal	*	12 inches (30 cm)*	K	Clearance to a mechanical air supply inlet	6 feet (1.83 m)	3 feet (91 cm) above if within 10 feet (3 m) horizontally		
E	Clearance to unventilated soffit	*	12 inches (30 cm)*	L	Clearance above paved sidewalk or paved driveway located on public property	7 feet (2.13 m)†	7 feet (2.13 m)†*		
F	Clearance to outside corner	2 feet (60 cm)*	2 feet (60 cm)*	M	Clearance under veranda, porch, deck, or balcony	12 inches (30 cm) ‡	12 inches (30 cm) ‡*		
G	Clearance to inside corner	18 inches (45 cm)*	18 inches (45 cm)*						

1 In accordance with the current CSA B149.1, Natural Gas and Propane Installation Code.

2 In accordance with the current ANSI Z223.1/NFPA 54, National Fuel Gas Code.

† A vent shall not terminate where it may cause hazardous frost or ice accumulations on adjacent property surfaces.

‡ Permitted only if veranda, porch, deck, or balcony is fully open on a minimum of two sides beneath the floor.

* Clearance in accordance with local installation codes and the requirements of the gas supplier and the manufacturer’s installation instructions.

VERTICAL VENT TERMINAL INSTALLATION

WHEN TERMINATING THROUGH A ROOF, THE FOLLOWING SPECIFICATIONS PERTAINING TO TERMINAL LOCATION MUST BE FOLLOWED.

1. Proper support must be provided for all pipe protruding through the roof.
2. The vertical roof terminations should be sealed with a plumbing roof boot or equivalent flashing.
3. The air intake termination and the exhaust vent termination must penetrate the same side of roof.
4. The center line of the air intake termination and the center line of the exhaust vent termination must be no closer than 24" (61cm). See Figure 18 and Figure 19.

FLAT ROOF INSTALLATION

On flat roof installations the air intake and the exhaust vent terminations must be a minimum of 24 inches (60 cm) above any parapet, vertical wall or structure within 10 feet (3 m) horizontally. See Figure 20.

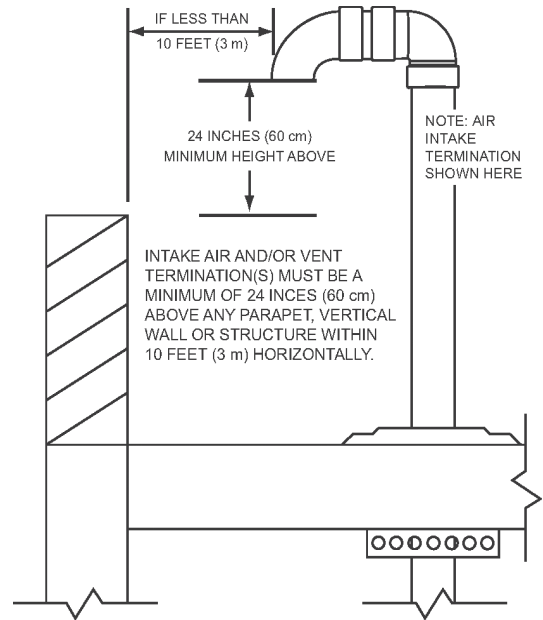

VERTICAL TERMINATION(S) FLAT ROOF CLEARANCE
INTAKE AIR AND/OR VENT (EXHAUST)

Figure 20

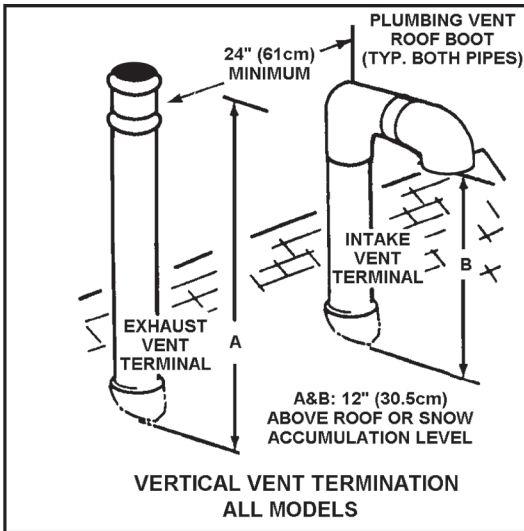

Figure 18

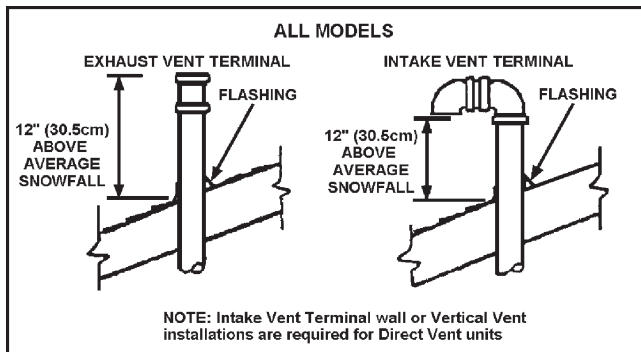

Figure 19

ROOF VENT

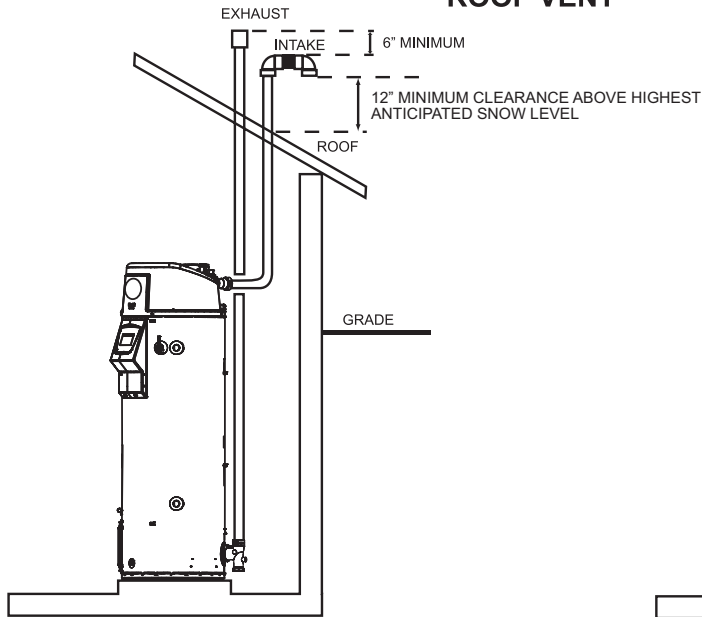

Figure 21

CONCENTRIC VENT
12" MINIMUM CLEARANCE ABOVE HIGHEST ANTICIPATED SNOW LEVEL

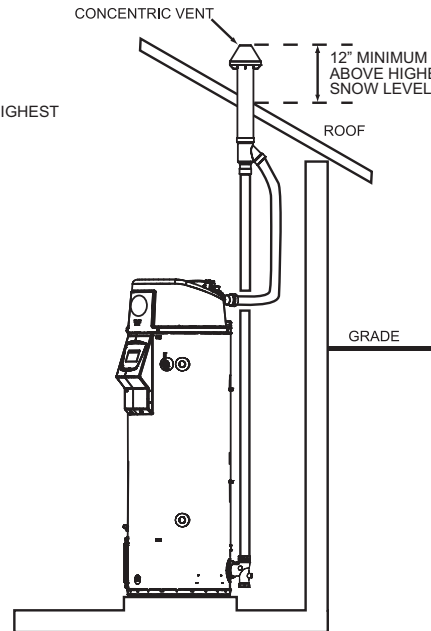

Figure 22

SIDEWALL VENT

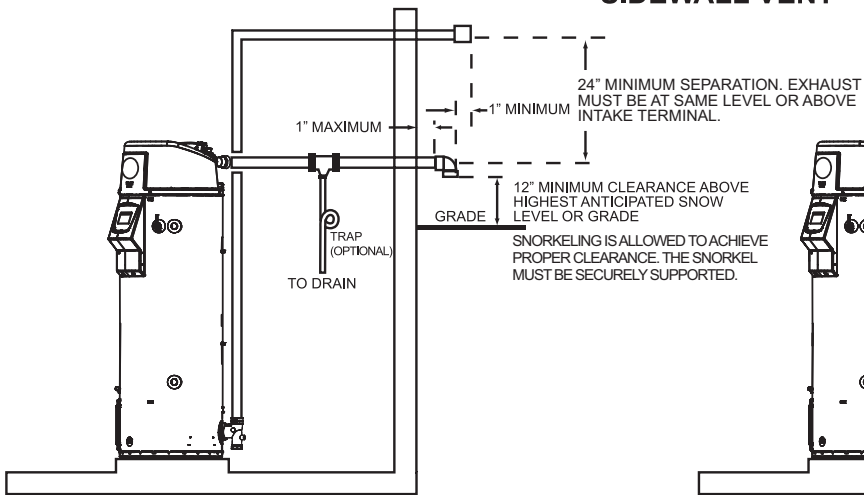

Figure 23

IMPORTANT: INTAKE LEG MUST BE FACING UP

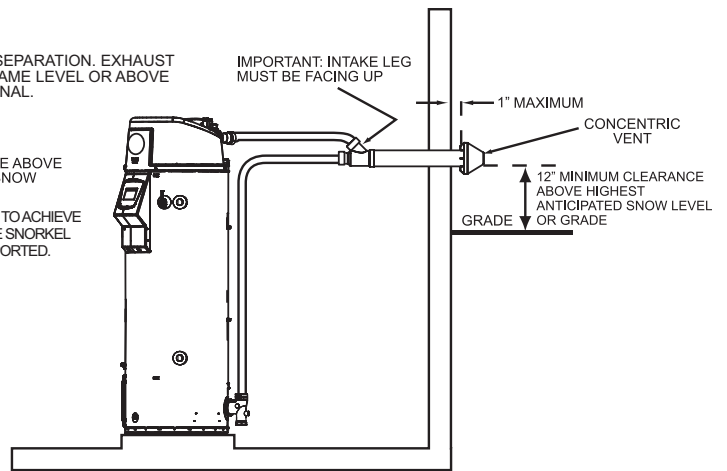

Figure 24

CONCENTRIC VENT INSTALLATION

This water heater is certified for concentric venting with concentric vent kit #9006328005. Follow instructions below for proper installations.

Table 8 – KIT COMPONENTS

Item	Description	Qty.
Rain Cap	3 in.	1
SDR-26 pipe	4 in. dia.	1
SDR-26 pipe	2½ in. dia.	1
Y Concentric Fitting	3 in.	1
Installation Instructions	196151	1

Field supplied pipe and fittings are required to complete the installation.

This concentric vent termination kit may be used with 3 inch diameter pipe systems.

SAFETY CONSIDERATIONS

Installing and servicing water heating equipment can be hazardous due to gas and electrical components. Installation and service of the concentric vent termination requires ability equivalent to that of a qualified installer or qualified service technician, see Page 7. All precautions in the literature, on tags, and labels attached to the unit must be observed.

Follow all safety codes. Wear safety glasses and work gloves.

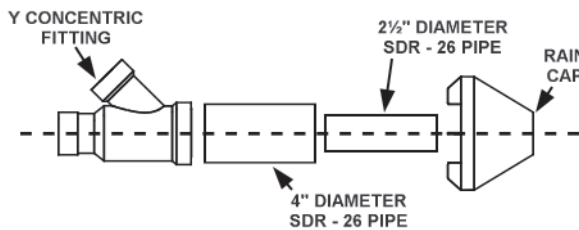

Figure 25

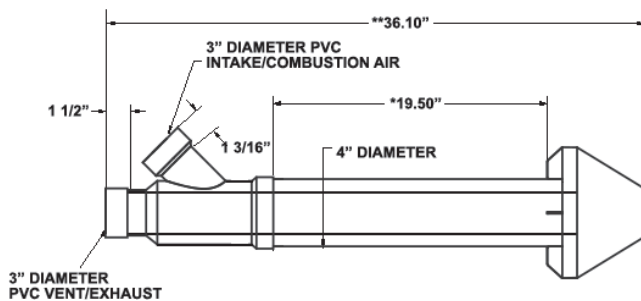

Figure 26

* Dimension 19.50 in. may also be shortened by cutting the pipes, provided in the kit, to 12 in. minimum.

** Dimension 36.10 will change accordingly as dimension 19.50 in. is shortened.

Do not use field-supplied couplings to extend pipes. Airflow restriction will occur and the heater pressure switch may cause intermittent operation.

INSTALLATION VERTICAL ROOF TERMINATION

1. Determine best location for termination kit.

NOTE: Roof termination is preferred since it is less susceptible to damage, has reduced chances to intake contaminants, and less visible vent vapors.

2. Cut 1 hole (5 in. diameter)

3. Partially assemble concentric vent termination kit.

- Cement Y concentric fitting to larger diameter kit pipe, see Figure 25.
- Cement rain cap to smaller diameter kit pipe, see Figure 25.

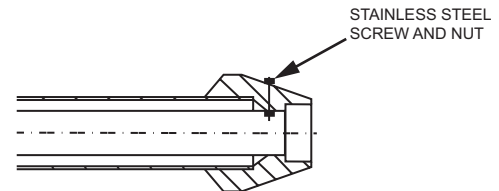

Figure 27

NOTE: Instead of cementing the smaller pipe to the rain cap, a stainless steel screw may be used to secure the 2 components together when field disassembly is desired for cleaning, see Figure 27. Locate the drill location dimple on the outside of the rain cap; at this location, drill a 3/16" hole through the cap and the inner pipe wall with the path of the hole perpendicular to the inner pipe NOT the outside of the cap; insert the screw and tighten the bolt; do not over tighten.

When using alternate screw method, failure to drill adequate holes may cause cracking of PVC components, allowing combustion products to be recirculated. Failure to follow this warning could result in personal injury or death.

Do not operate the heater with rain cap removed or recirculation of combustion products may occur. Water may also collect inside larger combustion-air pipe and flow to the burner enclosure. Failure to follow this warning could result in product damage or improper operation, personal injury or death.

4. Install Y concentric fitting and pipe assembly through structure's hole and field supplied roof boot/flashing.

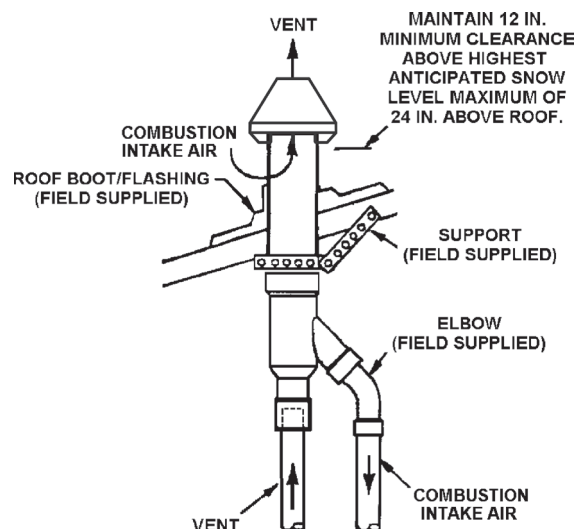

Figure 28

NOTE: Do not allow insulation or other materials to accumulate inside pipe assembly when installing through hole.

5. Secure assembly to roof structure as shown in Figure 28 using field supplied metal strapping or equivalent support material.

NOTE: Ensure termination height is above the roof surface or anticipated snow level as shown in Figure 28.

6. Install rain cap and small diameter pipe assembly in roof penetration assembly, Ensure small diameter pipe is cemented and bottomed in Y concentric fitting.

7. Cement water heater combustion air intake and vent pipes to concentric vent termination assembly. See Figure 28 for proper pipe attachment.

8. Operate heater through 1 heat cycle to ensure combustion air and vent pipes are properly connected to concentric vent termination connections.

FLAT ROOF INSTALLATION

When installing a concentric termination vertically through a flat roof, the termination's vent cap must be a minimum of 10 feet (3 m) away from any parapet, vertical wall or structure as shown in Figure 29.

If this required 10 foot (3 m) distance to a parapet, vertical wall or structure cannot be maintained, standard terminations must be used. See Vertical Vent Termination Installation.

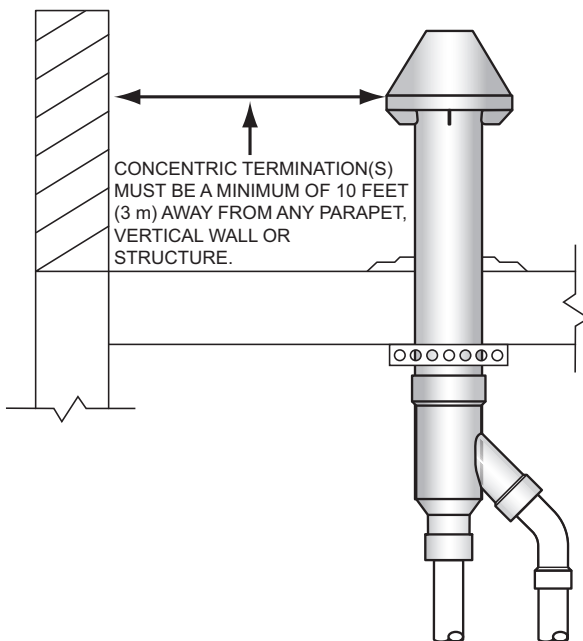

**CONCENTRIC TERMINATION
FLAT ROOF CLEARANCE**

Figure 29

INSTALLATION SIDE WALL TERMINATION

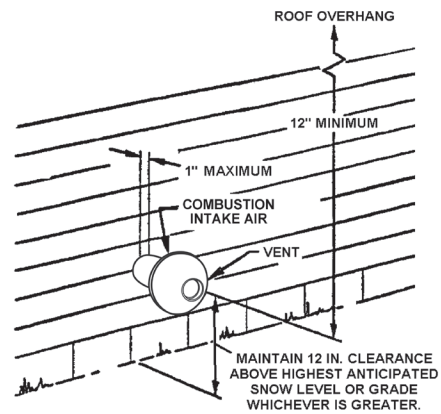

Figure 30

1. Determine best location for termination kit.

NOTE: Consideration for the following should be used when determining an appropriate location for the termination kit:

- Termination kit positioned where the vent vapors will not damage plants/shrubs or air conditioning equipment.
- Termination kit positioned so it will not be affected by wind eddy that may allow recirculation of combustion products, or airborne leaves, or light snow.
- Termination kit positioned where it will not get damaged or be subjected to foreign objects, such as stones, balls, etc.
- Termination kit positioned where the vent vapors will not be objectionable.

NOTE: See Venting Installation section (starting on Page 25) in this manual for additional vent location requirements.

2. Cut 1 hole (5 in. diameter).

3. Partially assemble concentric vent termination kit.

- a) Cement the Y concentric fitting to larger diameter kit pipe, see Figure 25.
- b) Cement the rain cap to the smaller diameter kit pipe, see Figure 25.

NOTE: Instead of cementing the smaller pipe to the rain cap, a field-supplied stainless steel screw may be used to secure the 2 components together when field disassembly is desired for cleaning, see Figure 27.

When using alternate screw assembly method, drill clearance hole in rain cap and pilot hole in vent pipe for screw being used. Failure to drill adequate holes may cause cracking of PVC components, allowing combustion products to be recirculated. Failure to follow this warning could result in personal injury or death.

Do not operate the heater with rain cap removed or recirculation of combustion products may occur. Water may also collect inside larger combustion-air pipe and flow to the burner enclosure. Failure to follow this warning could result in product damage or improper operation, personal injury or death.

4. Install Y concentric fitting and pipe assembly through structure's hole.

NOTE: Do not allow insulation or other materials to accumulate inside pipe assembly when installing through hole.

5. Install rain cap and small diameter pipe assembly in Y concentric fitting and large pipe assembly. Ensure small diameter pipe is bottomed and cemented in Y concentric fitting.

6. Ensure the Y connection is oriented so the air intake side of Y is on top, see Figure 31.
7. Secure assembly to structure as shown in Figure 31 using field-supplied metal strapping or equivalent support material.

NOTE: Ensure termination location clearance dimensions are as shown in Figure 30, 32 and 33. When extending the length of the 4" pipe, the added length beyond 21-1/8" must be deducted from the maximum equivalent feet of vent pipe.

NOTE: If assembly needs to be extended to allow side wall thickness requirement, the 2 pipes supplied in the kit may be replaced by using same diameter, field-supplied SDR-26 PVC (D2241) pipe. Do not extend 21 1/8" (53.6 cm) dimension more than 60" (1.5 m). See Figure 25.

Do not use field-supplied couplings to extend pipes. Airflow restriction will occur and the heater pressure switch may cause intermittent operation.

8. Cement heater combustion-air and vent pipes to concentric vent termination assembly. See Figure 31 for proper pipe orientation and attachment.
9. Operate heater through 1 heat cycle to ensure combustion-air and vent pipes are properly connected to concentric vent termination connections.

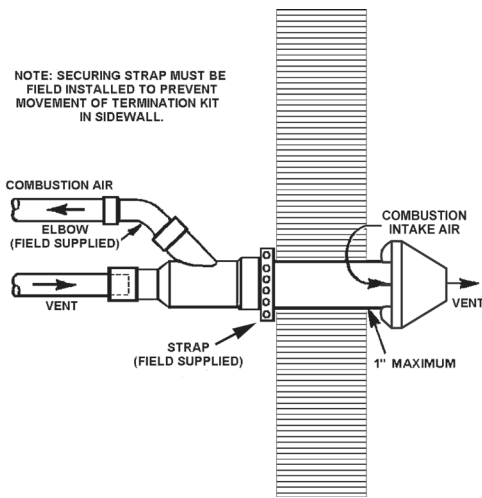

Figure 31

MULTI-CONCENTRIC VENT TERMINATIONS

When two or more water heaters are direct vented with concentric vent terminations near each other, each water heater must be individually vented. NEVER common vent this water heater. When two or more water heaters are direct vented using concentric vent terminations, the water heaters may be vented as shown in Figure 32 and Figure 33.

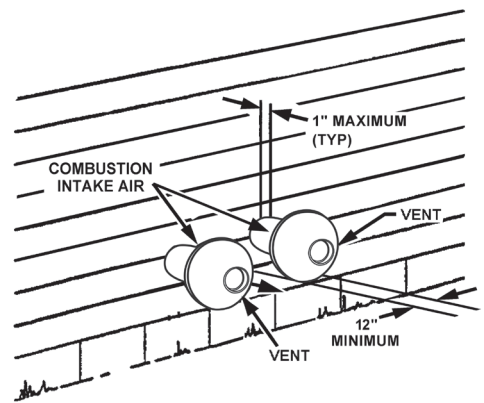

Figure 32 CONCENTRIC VENT TERMINATIONS FOR HORIZONTAL DIRECT VENTING

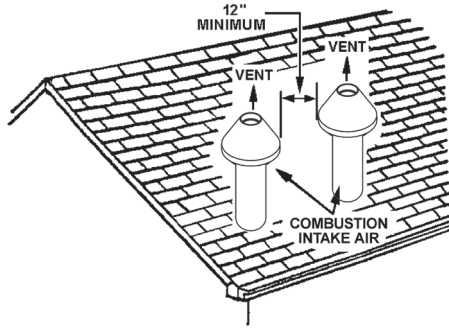

Figure 33 CONCENTRIC VENT TERMINATIONS FOR VERTICAL DIRECT VENTING THROUGH A ROOF

LOW PROFILE TERMINATION INSTALLATION

This water heater is certified for sidewall direct venting with IPEX System 636 Low Profile Vent Kit. Follow instructions below for proper installations.

All termination kits must be located and installed in accordance with local codes or the current editions of the National Fuel Gas Code (ANSI Z223.1/NFPA 54) or the Natural Gas and Propane Installation Code (CAN/CSA B149.1).

1. Once the proper location has been determined, cut 2 holes in the wall large enough to accommodate the pipe. Pipe diameters and distance between hole centers can be found in Table 9.
2. Slide both the intake and exhaust pipes through the holes. Solvent cement both pipes to the base of the vent termination kit, follow the solvent cementing procedures outlined in the IPEX System 636 Installation Guide, which is available on the web www.ipexinc.com.
3. To fasten the Base to the wall, use the supplied screws and anchors. A 3/16" (5mm) hole, 1-3/16" (30mm) deep, will need to be drilled for the anchors. Locate the anchor hole using the base as a template.
4. Screw the Cap to the Base using the supplied screws.
5. Once the vent termination and pipes are secured, the wall penetrations will need to be sealed from the interior using a PVC-compatible sealant material.
6. All vent pipes and air inlets must terminate at the same height to avoid possibility of severe personal injury, death, or substantial property damage.
8. Operate heater through 1 heat cycle to ensure combustion-air and vent pipes are properly connected to concentric vent termination connections.

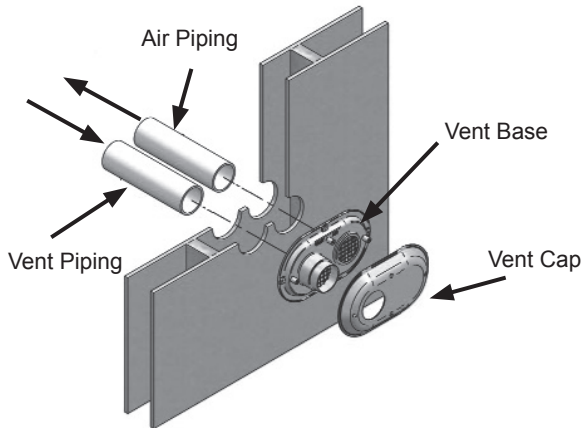

Figure 34

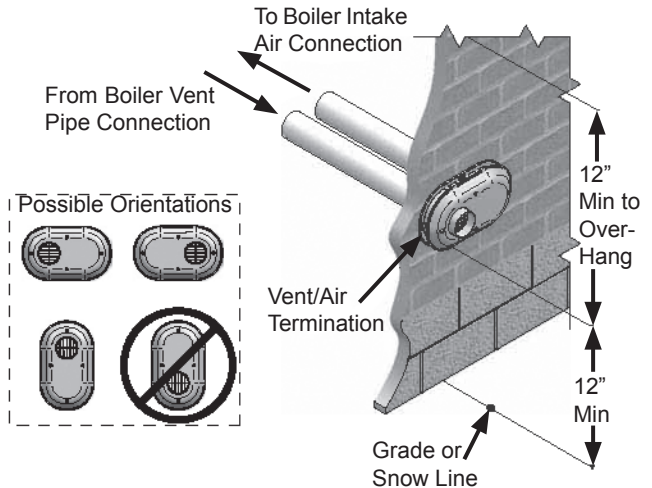

Figure 35

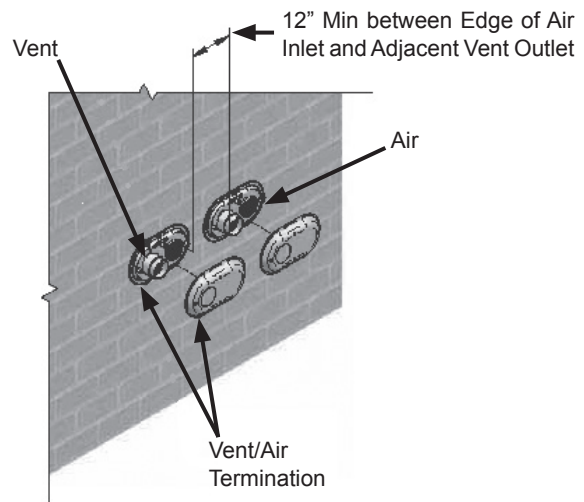

Figure 36

Table 9

Low Profile Termination Kits - Dimensions				
AOS Kit Number	IPEX Part Number	Description	Pipe Outside Diameter	Hole Spacing (ctr to ctr)
9008952005	196984	2" Flush Mount Vent Kit	2.375"	5.6"
9008933005	196985	3" Flush Mount Vent Kit	3.5"	5.6"

Table 10

Each Kit Contains	
Qty	Item Description
1	Base (two holes)
1	Cap (one hole)
8	Stainless Steek Screws
4	Plastic Anchors

LIGHTING AND OPERATION LABELS

FOR YOUR SAFETY READ BEFORE OPERATING



WARNING: If you do not follow these instructions exactly, a fire or explosion may result causing property damage, personal injury or loss of life.



BEFORE OPERATING: ENTIRE SYSTEM MUST BE FILLED WITH WATER AND AIR PURGED FROM ALL LINES.

- A. This appliance does not have a pilot. It is equipped with an ignition device which automatically lights the burner. **Do not try to light the burner by hand.**
- B. BEFORE OPERATING smell all around the appliance area for gas. Be sure to smell next to the floor because some gas is heavier than air and will settle on the floor.
- WHAT TO DO IF YOU SMELL GAS
- Do not try to light any appliance.
 - Do not touch any electric switch; do not use any phone in your building.
 - Immediately call your gas supplier from a neighbor's phone. Follow the gas supplier's instructions.
- If you cannot reach your gas supplier, call the fire department.
- C. Use only your hand to push in or turn the gas control knob. Never use tools. If the knob will not push in or turn by hand, don't try to repair it, call a qualified service technician. Force or attempted repair may result in a fire or explosion.
- D. Do not use this appliance if any part has been under water. Immediately call a qualified service technician to inspect the appliance and to replace any part of the control system and any gas control which has been under water.

OPERATING INSTRUCTIONS

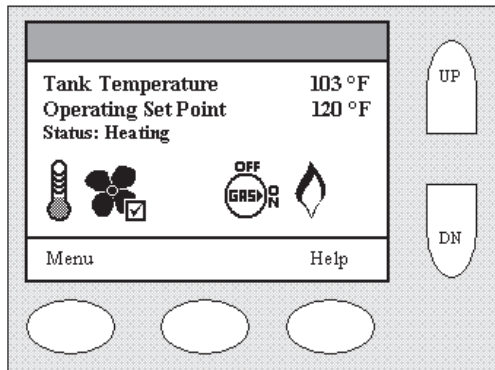

1. STOP! Read the safety information above on this label.
 2. Turn on all electrical power to the appliance.
 3. Set the "ENABLE/DISABLE" switch on the control panel to the "ENABLE" position.
 4. Set the thermostat to lowest setting.
 5. Set the "ENABLE/DISABLE" switch on the control panel to the "DISABLE" position.
 6. This appliance is equipped with an ignition device which automatically lights the burner. **DO NOT TRY TO LIGHT THE BURNER BY HAND.**
 7. Wait five (5) minutes to clear out any gas. Then smell for gas, including near the floor. If you smell gas, STOP! Follow "B" in the safety information above on this label. If you don't smell gas, go to the next step.
 8. Set the "ENABLE/DISABLE" switch on the control panel to the "ENABLE" position.
 9. Set thermostat to desired setting.
 10. **CAUTION: Hotter water increases the risk of scald injury. Before changing temperature setting, see instruction manual.**
 10. If the appliance will not operate, follow the instructions "TO TURN OFF GAS TO APPLIANCE" and call your service technician or gas supplier.
- WARNING: TURN OFF ALL ELECTRIC POWER BEFORE SERVICING.**

TO TURN OFF GAS TO APPLIANCE

1. Set the thermostat to lowest setting.
2. Set the ENABLE/DISABLE switch on the control panel to the "DISABLE" position.
3. Turn off all electrical power to the appliance if service is to be performed.

TEMPERATURE REGULATION

It is recommended that lower water temperatures be used to avoid the risk of scalding. It is further recommended, in all cases, that the water temperatures be set for the lowest temperature which satisfies your hot water needs. This will also provide the most energy efficient operation of the water heater.

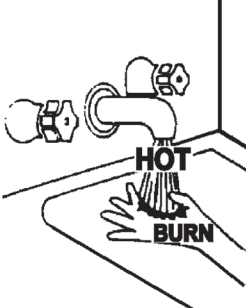

⚠ DANGER

Water temperature over 125°F (52°C) can cause severe burns instantly resulting in severe injury or death.

Children, the elderly, and the physically or mentally disabled are at highest risk for scald injury.

Feel water before bathing or showering.

Temperature limiting valves are available.

Read instruction manual for safe temperature setting.

HOT WATER CAN SCALD: Water heaters are intended to produce hot water. Water heated to a temperature which will satisfy space heating, clothes washing, dish washing, and other sanitizing needs can scald and permanently injure you upon contact. Some people are more likely to be permanently injured by hot water than others. These include the elderly, children, the infirm, or physically/mentally handicapped. If anyone using hot water from this heater fits into one of these groups or if there is a local code or state law requiring a certain temperature water at the hot water tap, then you must take special precautions. In addition to using the lowest possible temperature setting that satisfies your hot water needs, a means such as a mixing valve, should be used at the hot water taps used by these people or at the water heater. Mixing valves are available at plumbing supply or hardware stores. Follow manufacturer's instructions for installation of the valves. Before changing the factory setting on the thermostat, read the Temperature Regulation section in this manual.

Never allow small children to use a hot water tap, or to draw their own bath water. Never leave a child or handicapped person unattended in a bathtub or shower.

SETTING THE WATER HEATER TEMPERATURE AT 120°F/49°C WILL REDUCE THE RISK OF SCALDS. Some states require settings at specific lower temperatures.

The water temperature is controlled using the Temperature Control on the Display at the front of the unit (See Figure 1B and Figure 1C). This control utilizes a temperature probe to determine the tank temperature. The temperature probe is located behind the heater's front display.

The temperature may be adjusted from 90°F/32°C to 180°F/82°C. The temperature was preset to 120°F/49°C before the heater was shipped from the factory. It is recommended that lower water temperature be used to avoid the risk of scalding. It is further recommended, in all cases, that the water temperature be set for the lowest temperature which satisfies your hot water needs. This will also provide the most energy efficient operation of the water heater and minimize scale formation.

Valves for reducing the point-of-use temperature by mixing cold and hot water are available. Also available are inexpensive devices that attach to faucets to limit hot water temperatures. Contact a licensed plumber or the local plumbing authority.

The table below shows the approximate time-to-burn relationship for normal adult skin. Short repeated heating cycles caused by small hot water uses can cause temperatures at the point of use to exceed the thermostat setting by up to 20°F/11°C. If you experience this type of use, you should consider using lower temperature settings to reduce scald hazards.

In all cases, the following burn table must be used. Its appearance may be altered to comply with each manual's style, but the content must remain unchanged. NOTE: If the manual is to be used outside of the United States, metric equivalents (Celsius) must be added to the table.

Table 11

Water Temperature °F (°C)	Time for 1st Degree Burn (Less Severe Burns)	Time for Permanent Burns 2nd & 3rd Degree (Most Severe Burns)
110 (43.3)	(normal shower temp.)	
116 (46.7)	(pain threshold)	
116 (46.7)	35 minutes	45 minutes
122 (50)	1 minute	5 minutes
131 (55)	5 seconds	25 seconds
140 (60)	2 seconds	5 seconds
149 (65)	1 second	2 seconds
154 (67.8)	instantaneous	1 second
<small>(U.S. Government Memorandum, C.P.S.C., Peter L. Armstrong, Sept. 15, 1978)</small>		

HI LIMIT SWITCH (ECO)

This water heater is equipped with an ECO (energy cut out) non adjustable high temperature limit switch. The ECO is a normally closed switch that opens (activates) on a rise in temperature. The ECO is located inside the Temperature Probe (two red wires). The ECO switch contacts will open when the water temperature reaches approximately 202°F (94°C) and close at approximately 140°F (49°C).

If the ECO activates (contacts open) due to abnormally high water temperatures in the storage tank the control system will immediately de-energize the 24 VAC Gas Control Valve and end the current heating cycle. The control system will lock out disabling further heating operation. The control system will display the Energy Cut Out (ECO) Fault message on the LCD screen. It is important that a Qualified Service Technician be contacted to determine the reason for the ECO activation before resetting the ECO. Once the reason has been determined and corrected the ECO can be reset as follows:

Should the ECO activate, the water temperature must drop below 140°F (49°C) before the control system can be reset. Once the water temperature has cooled below this point the power supply to the water heater must be turned off and on again to reset the control system.

Contact your dealer or servicer if continued high limit switch operation occurs.

CONTROL SYSTEM OPERATION

OVERVIEW

The water heaters covered in this manual are equipped with an electronic control system that regulates water temperature inside the storage tank. Heating cycles and ignition are managed by the control system. The ECO (energy cut out), Flame Sensor, pressure switches and Temperature Probe is monitored by the control system. The Combustion Blower, Igniter and the 24 Volt Gas Control Valve are all energized by the control system.

The main components of the control system are a UIM (user interface module) and a CCB (central control board). The UIM is located on the top front side of the water heater. The CCB is mounted on top of the water heater inside a protective enclosure. This unit is equipped with an Enable/Disable switch. To operate unit, make sure the switch is set to Enable.

CONTROL SYSTEM NAVIGATION

All operational information and user settings are displayed and accessed from the UIM. The UIM houses the control system's LCD (liquid crystal display) and five snap acting (momentary) user input buttons; an up, down and three multifunction operational buttons below the LCD, see Figure 37.

USER INPUT BUTTONS

- The up and down buttons are used to navigate menus and adjust user settings.
- The operational buttons are used to enter/exit menus, select menu items, activate adjustment modes and confirm or cancel new user settings. The operational buttons are multifunctional, their current function is defined by the text that appears directly above each button on the LCD screen.

THE DESKTOP SCREEN

During normal operation the control system will display the Desktop screen on the LCD which is the default screen. The control system will return to the Desktop screen when there are no active Fault or Alert conditions or when there has been no user input for several minutes.

- Manufacturer and water heater model information is displayed in Title Bar at the top of the Desktop screen. Menu titles are displayed in the Title Bar when navigating the control system menus.
- The first temperature shown on the Desktop screen, Tank Temperature, is the temperature of the water inside the water heater's storage tank - commercial models only.
- The Operating Set Point is also shown on the Desktop screen. The Operating Set Point is the temperature at which the control system will maintain the water inside the storage tank.
- Beneath the Operating Set Point is the Status line. The Status line shows the current operational state of the control system in real time. See Table 13 for a description of the various operating states.
- The Desktop screen also displays animated Status Icons to convey operational information, see Table 12 for a complete list and description of the Status Icons.

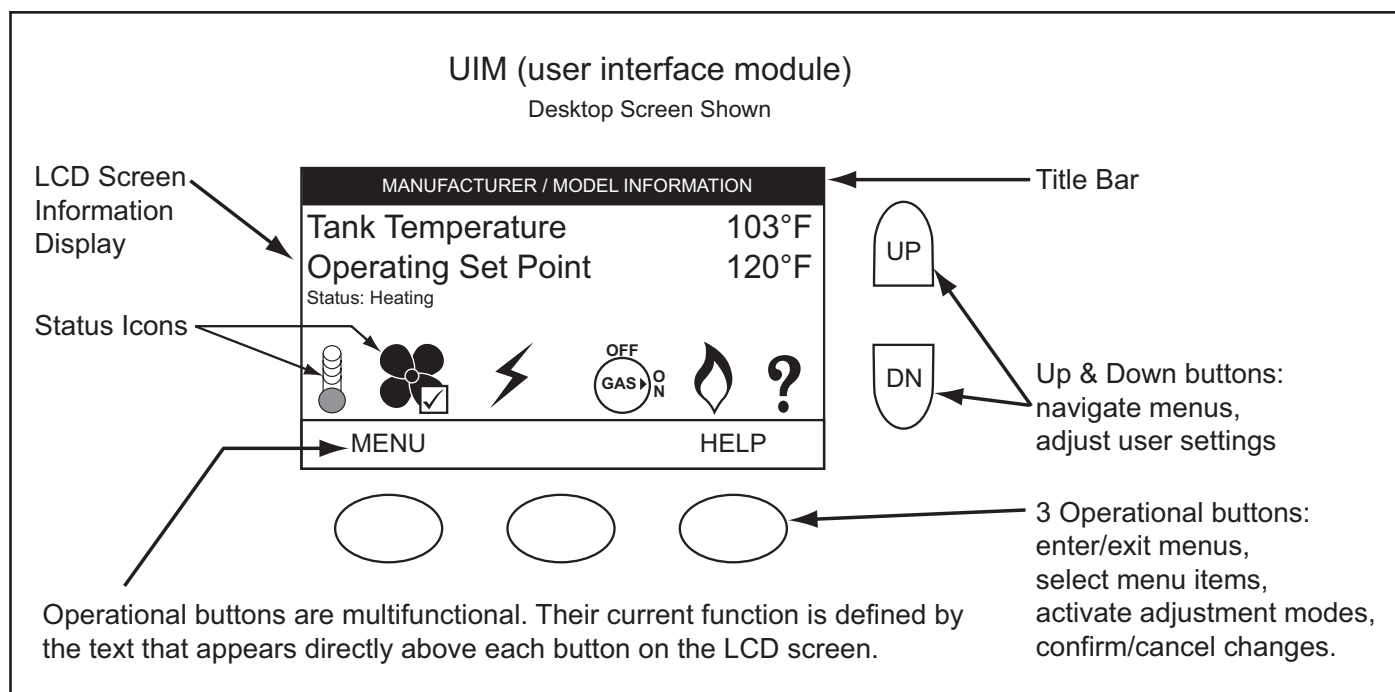











Figure 37

STATUS ICONS

The Status Icons are displayed on the Desktop screen and convey operational and diagnostic information. The icons are described in the table below.

Table 12 – STATUS ICONS

Icon	Description
	Water temperature in the tank has fallen. Shaded area of the animated thermometer icon will rise and fall in response to water temperature in the storage tank as sensed from the Temperature Probe.
	Water temperature in the tank has reached the Operating Set Point. The control system enters the Standby mode.
	The control is unable to initiate a heating cycle. This will happen whenever a Fault condition is detected by the control system or when the Enable/Disable switch on front panel is in disable position. Display will read "Status: Water Heating Disabled".
	The Combustion Blower is being energized.
	The Blower Prover pressure switch contacts have closed. The check mark icon is visual confirmation of contact closure.
	The Igniter is being energized.
	The 24 Volt Gas Control Valve is being energized.
	The control system has sensed flame at the Main Burner from the Flame Sensor.
	The control system has declared a Fault condition and must be inspected/serviced by a Qualified Service Technician. Fault message details can be viewed in the Current Fault menu. Heating operation is disabled (control system lock out) until the condition that caused the Fault is corrected. Water Heating Enable/Disable Switch must be cycled off and on to reset the control system. NOTE: Cycling Water Heating Enable/Disable Switch will not reset the control system if the condition that caused the Fault has not been corrected.
	The control system has declared an Alert condition and must be inspected/serviced by a Qualified Service Technician. The water heater will continue to operate during an Alert condition.

OPERATING STATES

The current operational state of the water heater is displayed on the Desktop screen as the Status. The common operational states are described in the table below.

Table 13 – OPERATING STATES

State	Description
Standby	The water heater is not in an active heating cycle. IE: the Tank Temperature is at or above the Operating Set Point minus temperature differential.
Input Verification	The control system is conducting a diagnostic check at the beginning of a heating cycle.
Water Heating Disabled	A Fault condition is detected by the control or when the Enable/Disable switch on front panel is an open circuit.
Pre-Purge	The Combustion Blower is energized to flush residual flue gases from the combustion chamber prior to ignition.
Igniter	The Igniter is energized and is ready to ensure proper ignition.
Gas Control Valve On	The 24 Volt Gas Control Valve is energized and opens to allow fuel gas to flow to the Main Burner.
Inter-Purge	The Combustion Blower is energized to flush residual fuel gas from the combustion chamber after a failed ignition attempt.
Heating	Ignition was successful, flame sensing current has been established. The water in the storage tank is being heated.
Post-Purge	The Combustion Blower is energized to flush residual flue gases from the combustion chamber at the end of a heating cycle.
Fault	The control system has detected a Fault condition. Heating operation is disabled (control system lock out) until the Fault condition is corrected. Water Heating Enable/Disable Switch must be cycled off and on to reset the control system. NOTE: Cycling Water Heating Enable/Disable Switch will not reset the control system if the condition that caused the Fault has not been corrected.
Heating Disabled	The heating is disabled by the Enable/Disable switch in front of the unit.

CONTROL SYSTEM MENUS

From the Desktop screen pressing the Operational button directly below Menu on the LCD will display the Main Menu. This is where all control system menus are located. The table below describes the control system menus.

Table 14 – CONTROL SYSTEM MENUS

Menu	Description
Temperatures	Most commonly accessed menu. Contains the Operating Set Point and Differential user settings.
Heater Status	This menu displays the current state of all pressure switches and the ECO (open/closed). The on/off status of the Combustion Blower, 24 Volt Gas Control Valve, Igniter, Flame Sensor and other monitored water heater components are displayed in this menu.
Display Settings	Temperature units (°F or °C), the LCD appearance (brightness/contrast) and backlight delay user adjustable settings are located in this menu.
Heater Information	Elapsed time of operation, total heating cycle time, heating cycle count, heating on time along with UIM and CCB software revisions can be viewed in this menu.
Current Fault	Displays any current Alert or Fault messages.
Fault History	This control system menu retains a list of the last nine (9) Fault and Alert messages with a time stamp. The newest event will replace the oldest. Fault history memory is cleared after 30 days.
Fault Occurrence	This control system menu retains a running total of how many times each Fault condition has occurred since the water heater was first installed. Fault occurrences numbers are saved in the CCB memory indefinitely. NOTE: if the CCB is replaced during service the fault occurrence historical information for the water heater is lost.
Restore Factory Defaults	This control system feature allows the user to restore control system user settings to their factory default settings. Display Settings preferences ARE NOT changed when factory defaults are restored.
Help Screens	Text based operational and user information explaining how to change user settings, navigate the control system menus and icon descriptions.

USER SETTINGS & CONTROL SYSTEM MENUS

TEMPERATURES

OPERATING SET POINT AND DIFFERENTIAL ADJUSTMENT

The Operating Set Point is adjustable from 90°F (42°C) to 180°F (82°C) for commercial models. The factory setting is 120°F (49°C). The Differential is adjustable from 2° to 20°. The factory setting is 8°. These user settings are accessed from the Temperatures menu. These instructions explain how to adjust these settings and navigate the control system.

When the water temperature sensed by the control system from the Temperature Probe reaches the Operating Set Point the control system will end the heating cycle. A heating cycle will be activated again when the sensed water temperature drops below the Operating Set Point minus the Differential setting.

NOTE: Set the Operating Set Point to the lowest setting which produces an acceptable hot water supply for most efficient use. Lower Differential settings may cause excessive heating cycles (short-cycling) which can cause premature failure of components such as the igniter. Set the Differential at the highest setting which produces an acceptable hot water supply to prevent short cycling.

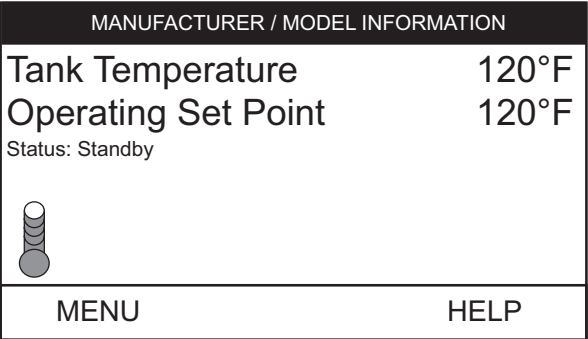
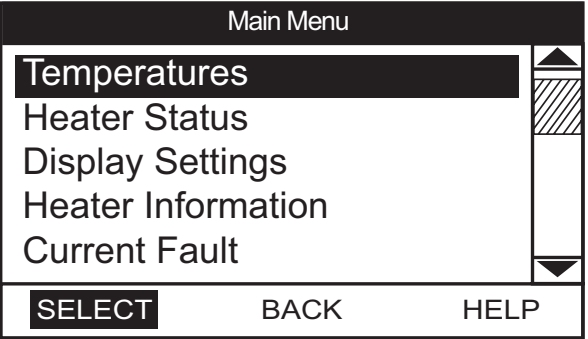
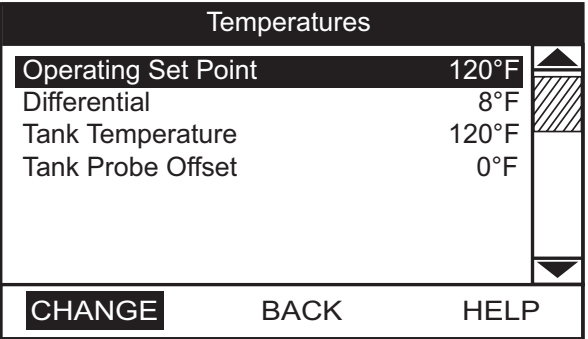
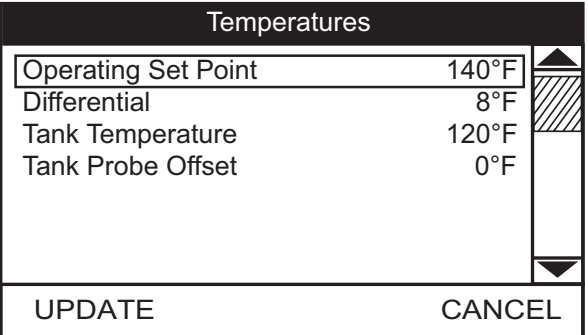
DESCRIPTION/ACTION	DISPLAY
<p>From the Desktop screen, press the Operational Button under MENU. The Main Menu screen will be displayed.</p>	
<p>The Main Menu is where all control system menus are listed, see Table 14 for a complete list and description of control system menus. Use the Up and Down Buttons to view all control system menus from the Main Menu.</p> <p>With Temperatures menu selected (highlighted in black) in the Main Menu screen, press the Operational Button under "SELECT" to enter the Temperatures menu.</p> <p>If the Temperatures menu is not selected use the Up and Down Buttons to select this menu item.</p>	
<p>With the Operating Set Point selected in the Temperatures menu, press the Operational Button underneath "CHANGE" to activate the adjustment mode for this menu item.</p> <p>If Operating Set Point is not selected use the Up and Down Buttons to select this menu item.</p> <p>NOTE: Higher Temperature settings increase wear and operating costs. Set the Operating Set Point to the lowest setting which produces an acceptable hot water supply. This will always provide the most energy efficient operation and longer life.</p>	
<p>With the adjustment mode for the Operating Set Point activated the selection bar will change from a black fill to a black outline.</p> <p>Use the Up and Down Buttons to change the current setting.</p> <p>Press the Operational Button under "UPDATE" to save the new setting. Press the Operational Button under "CANCEL" to discard changes and return to the previously saved setting.</p> <p>NOTE: Use this same procedure to change the Differential setting and other adjustable user settings in the control system menus.</p>	

TEMPERATURES (CONT)

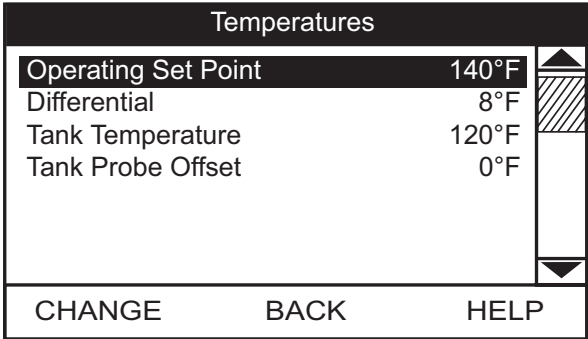
DESCRIPTION/ACTION	DISPLAY												
<ul style="list-style-type: none"> • Tank Temperature - non adjustable - control system sensed temperature from the Temperature Probe. • Tank Probe Offset - adjustable user setting, range -5° to +5°F (factory setting 0°F). The Tank Probe Offset is used to calibrate control system temperature sensing. This offsets to more effectively read point of use temperature in the tank. This feature can also be used to compensate for building recirculation loops (hot water returning to the storage tank) that may cause the heating cycles to terminate prematurely. Example: If the current sensed temperature from the temperature probe is 120°F (49°C) and the Offset setting for the probe is adjusted to a value other than 0°, the control system would calibrate or "offset" the sensed temperature from the probe. Heating cycles would be activated and deactivated based on the calibrated (offset) temperature. <p>NOTE: The Tank Probe Offset should only be used if the hot water supply temperature varies greatly from the Operating Set Point setting. These settings are adjusted in the same way described for the Operating Set Point and Differential Adjustment.</p>	 <p style="text-align: center;">Temperatures</p> <table border="1" style="width: 100%; border-collapse: collapse;"> <tr> <td style="padding: 2px;">Operating Set Point</td> <td style="text-align: right; padding: 2px;">140°F</td> <td style="text-align: center;">▲</td> </tr> <tr> <td style="padding: 2px;">Differential</td> <td style="text-align: right; padding: 2px;">8°F</td> <td style="text-align: center;">▨</td> </tr> <tr> <td style="padding: 2px;">Tank Temperature</td> <td style="text-align: right; padding: 2px;">120°F</td> <td style="text-align: center;">□</td> </tr> <tr> <td style="padding: 2px;">Tank Probe Offset</td> <td style="text-align: right; padding: 2px;">0°F</td> <td style="text-align: center;">▼</td> </tr> </table> <p style="text-align: center; margin-top: 5px;">CHANGE BACK HELP</p>	Operating Set Point	140°F	▲	Differential	8°F	▨	Tank Temperature	120°F	□	Tank Probe Offset	0°F	▼
Operating Set Point	140°F	▲											
Differential	8°F	▨											
Tank Temperature	120°F	□											
Tank Probe Offset	0°F	▼											

HEATER STATUS

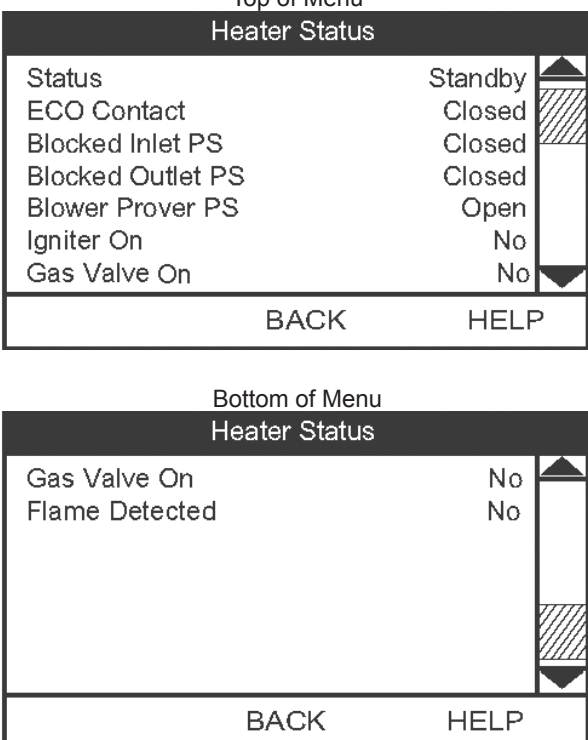
DESCRIPTION/ACTION	DISPLAY																											
<p>Select Heater Status from the Main Menu and press the Operational Button under "SELECT" to enter this menu. This menu contains non adjustable operational information. Use the Up & Down Buttons to navigate the menu.</p> <ul style="list-style-type: none"> • Status - displays the current Operating State, see Table 13 for a description of the various operational states. • ECO Contact, Blocked Inlet PS, Blocked Outlet PS, Blower Prover PS - displays the current state of the switch contacts; open or closed. • Igniter On, Gas Control Valve On - displays whether or not the control system is currently energizing these water heater components; yes = energized, no = de-energized. • Flame Detected - displays whether or not the control system has detected Main Burner flame during ignition from the Flame Sensor. 	 <p style="text-align: center;">Top of Menu Heater Status</p> <table border="1" style="width: 100%; border-collapse: collapse;"> <tr> <td style="padding: 2px;">Status</td> <td style="text-align: right; padding: 2px;">Standby</td> <td style="text-align: center;">▲</td> </tr> <tr> <td style="padding: 2px;">ECO Contact</td> <td style="text-align: right; padding: 2px;">Closed</td> <td style="text-align: center;">▨</td> </tr> <tr> <td style="padding: 2px;">Blocked Inlet PS</td> <td style="text-align: right; padding: 2px;">Closed</td> <td style="text-align: center;">□</td> </tr> <tr> <td style="padding: 2px;">Blocked Outlet PS</td> <td style="text-align: right; padding: 2px;">Closed</td> <td style="text-align: center;">□</td> </tr> <tr> <td style="padding: 2px;">Blower Prover PS</td> <td style="text-align: right; padding: 2px;">Open</td> <td style="text-align: center;">□</td> </tr> <tr> <td style="padding: 2px;">Igniter On</td> <td style="text-align: right; padding: 2px;">No</td> <td style="text-align: center;">□</td> </tr> <tr> <td style="padding: 2px;">Gas Valve On</td> <td style="text-align: right; padding: 2px;">No</td> <td style="text-align: center;">▼</td> </tr> </table> <p style="text-align: center; margin-top: 5px;">BACK HELP</p> <p style="text-align: center;">Bottom of Menu Heater Status</p> <table border="1" style="width: 100%; border-collapse: collapse;"> <tr> <td style="padding: 2px;">Gas Valve On</td> <td style="text-align: right; padding: 2px;">No</td> <td style="text-align: center;">▲</td> </tr> <tr> <td style="padding: 2px;">Flame Detected</td> <td style="text-align: right; padding: 2px;">No</td> <td style="text-align: center;">□</td> </tr> </table> <p style="text-align: center; margin-top: 5px;">BACK HELP</p>	Status	Standby	▲	ECO Contact	Closed	▨	Blocked Inlet PS	Closed	□	Blocked Outlet PS	Closed	□	Blower Prover PS	Open	□	Igniter On	No	□	Gas Valve On	No	▼	Gas Valve On	No	▲	Flame Detected	No	□
Status	Standby	▲																										
ECO Contact	Closed	▨																										
Blocked Inlet PS	Closed	□																										
Blocked Outlet PS	Closed	□																										
Blower Prover PS	Open	□																										
Igniter On	No	□																										
Gas Valve On	No	▼																										
Gas Valve On	No	▲																										
Flame Detected	No	□																										

DISPLAY SETTINGS

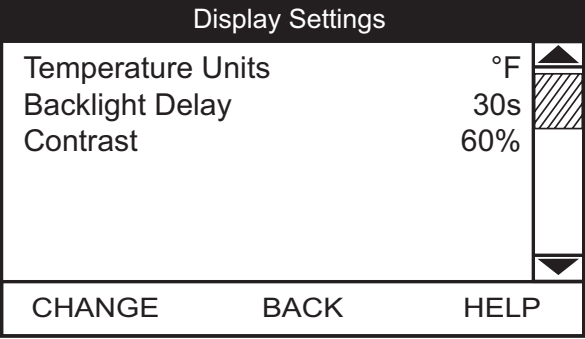
DESCRIPTION/ACTION	DISPLAY
<p>Select Display Settings from the Main Menu and press the Operational Button under "SELECT" to enter this menu. This menu contains adjustable display options for viewing information on the LCD screen. Use the Up & Down Buttons to navigate the menu.</p> <ul style="list-style-type: none"> • Temperature Units - Adjustable user setting that changes temperature units display to Celsius °C or Fahrenheit °F. • Backlight Delay - Adjustable user setting that determines how long the LCD backlight remains illuminated after a key has been pressed. Available settings are; Always Off, 10, 30 or 60 seconds and Always On. • Contrast - Adjustable user setting to adjust the LCD screen contrast between text and background. <p>NOTE: These settings are adjusted in the same way described for the Operating Set Point and Differential Adjustment.</p>	

HEATER INFORMATION

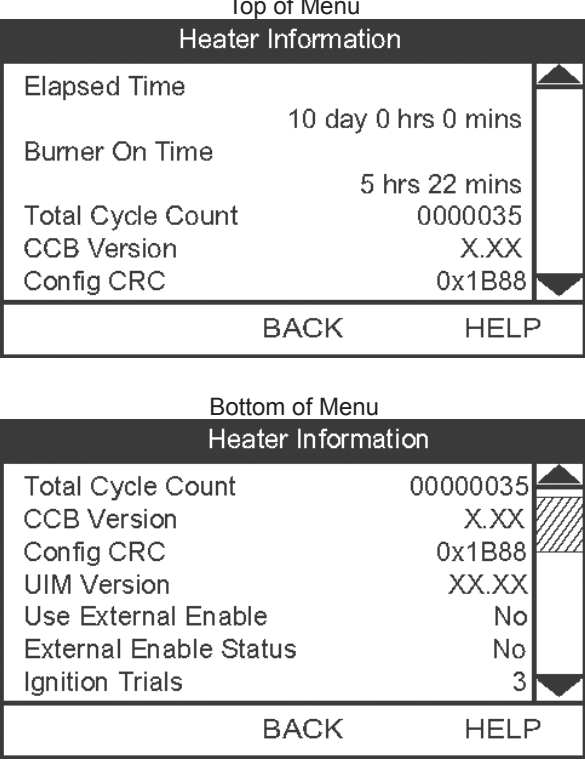
DESCRIPTION/ACTION	DISPLAY
<p>Select Heater Information from the Main Menu and press the Operational Button under "SELECT" to enter this menu. This menu contains non adjustable operational information.</p> <ul style="list-style-type: none"> • Elapsed Time - Total accumulated time the control system (water heater) has been energized. • Burner On Time - Total accumulated time the control system has been in the heating operating state; burner run time. • Total Cycle Count - Total accumulated count of heating cycles. • Config CRC - A number associated with the configuration data. • CCB Version - Software version for central control board. • UIM Version - Software version for user interface module. <p>NOTE: Historical data is stored in the CCB's memory. If this CCB is replaced during servicing the historical data on the CCB being replaced will be lost. The data stored in the new circuit board will no longer reflect the entire history of the water heater.</p> <p>The Elapsed Time, Burner On Time and Cycle Count indicate age, usage and wear.</p> <p>If the Cycle Count per day is high (divide cycle count by days to determine cycles per day) or the cycle duration is short (determine burner on time total minutes, divide burner on time total minutes by cycle count) consider raising the Differential setting to avoid short cycling and excessive component wear, see Operating Set Point and Differential Adjustment.</p> <p>This historical data can also be used to assist facilities managers in forecasting planned replacement of equipment to help avoid lengthy and costly hot water supply interruptions.</p> <ul style="list-style-type: none"> • Use External Enable - Enable/ Disable external control function. • External Enable Status - Status of external enable if Use External Enable is Yes. • Ignition Trials - The maximum number of ignition trials before lockout. 	

CURRENT FAULT

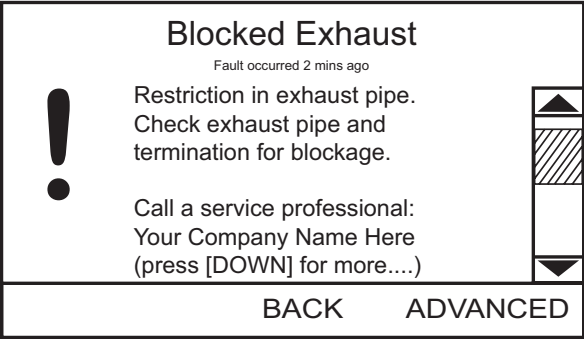
DESCRIPTION/ACTION	DISPLAY
<p>Select Current Fault from the Main Menu and press the Operational Button under "SELECT" to enter this menu. This menu contains non adjustable operational information. Use the Up & Down Buttons to navigate the menu.</p> <p>This menu contains the current Fault or Alert error message. The time the Fault or Alert message occurred appears directly below. A brief description of what causes the particular Fault or Alert condition appears below that. Pressing the Operational Button under "ADVANCED" will give more detailed service information and a list of possible causes for the Fault or Alert condition.</p> <p>If there is no Fault or Alert condition active this menu will not contain any information, "(none)" will be shown next to Current Fault in the Main menu.</p>	

FAULT HISTORY

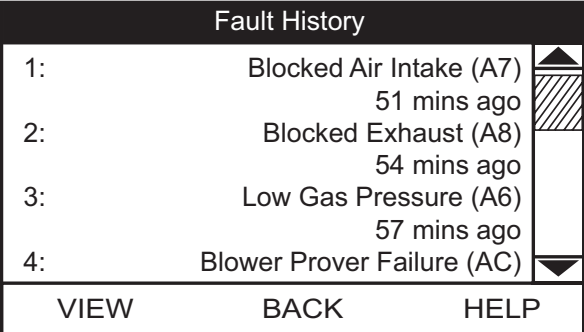
DESCRIPTION/ACTION	DISPLAY
<p>Select Fault History from the Main Menu and press the Operational Button under "SELECT" to enter this menu. This menu contains non adjustable operational information. Use the Up & Down Buttons to navigate the menu.</p> <p>This menu contains a list of the last nine (9) Fault and Alert messages with a time stamp. The newest event will replace the oldest.</p> <p>Press the Operational Button under "VIEW" to view details for each Fault or Alert message stored.</p> <p>NOTE: fault history memory is cleared after 30 days.</p>	

FAULT OCCURRENCE

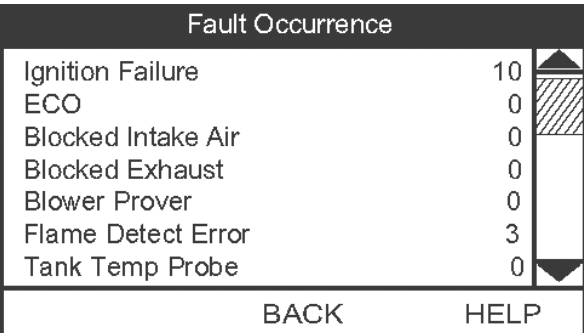

DESCRIPTION/ACTION	DISPLAY
<p>Select Fault Occurrence from the Main Menu and press the Operational Button under "SELECT" to enter this menu. This menu contains non adjustable operational information. Use the Up & Down Buttons to navigate the menu.</p> <p>This menu contains a running total of how many times each Fault condition has occurred since the water heater was first installed.</p> <p>NOTE: Historical data is stored in the CCB's memory. If this CCB is replaced during servicing the historical data on the CCB being replaced will be lost. The data stored in the new circuit board will no longer reflect the entire history of the water heater.</p>	

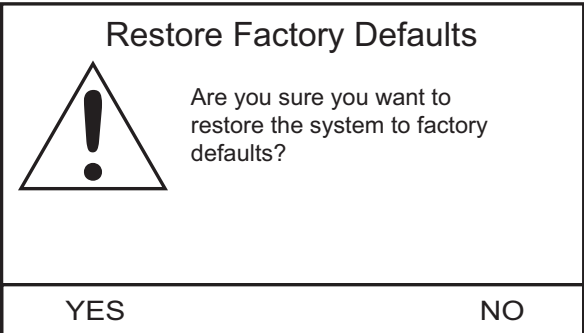
RESTORE FACTORY DEFAULTS

DESCRIPTION/ACTION	DISPLAY
<p>Select Restore Factory Defaults from the Main Menu and press the Operational Button under "SELECT" to enter this menu.</p> <p>To restore the adjustable user settings to their factory default settings press the Operational Button underneath "YES." The display will show text confirming the factory default settings have been restored.</p> <p>Press the Operational Button underneath "BACK" to exit the Restore Factory Defaults menu.</p>	

SERVICE CONTACT INFORMATION

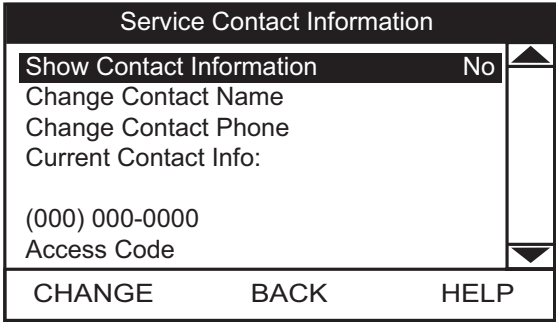
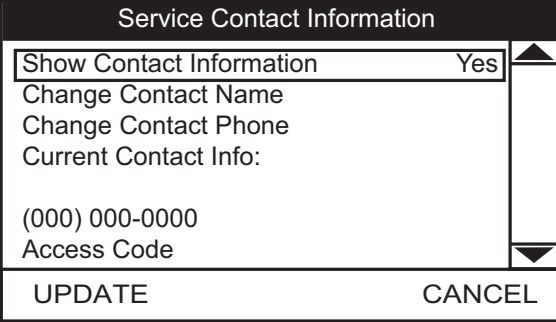
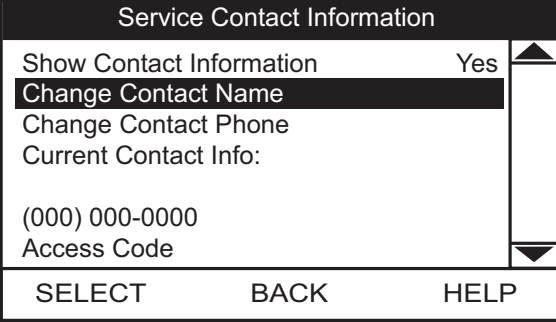
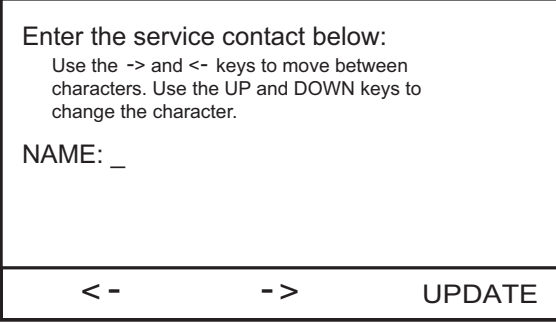
The control system has a discrete menu that Installing contractors and/or qualified service technician can access to enter contact information for their customers. This contact information will be displayed with all Fault and Alert messages.

DESCRIPTION/ACTION	DISPLAY
<p>From the Desktop Screen press and hold down the middle (unmarked) Operational Button for 30 seconds and then release it. This will launch a discrete menu where personalized contact information can be entered.</p> <p>Using the UP and DOWN buttons select (highlighted in black) the "Show Contact Information" menu item.</p> <p>Press the Operational Button under "CHANGE" to activate the adjustment mode for this parameter.</p>	 <p>The screenshot shows a menu titled "Service Contact Information". The first item, "Show Contact Information", is highlighted in black and has a status of "No". Other items include "Change Contact Name", "Change Contact Phone", and "Current Contact Info:". Below these is the phone number "(000) 000-0000" and "Access Code". At the bottom are buttons for "CHANGE", "BACK", and "HELP".</p>
<p>With the adjustment mode for "Show Contact Information" activated the selection bar will change from a black fill to a black outline.</p> <p>Use the Up and Down Buttons to change the setting from "No" to "Yes" and press the Operational Button underneath "UPDATE" to save the new setting.</p> <p>NOTE: The Access Code at the bottom of the Service Contact Information screen is for manufacturing purposes only. There are no user settings or information accessed through this menu item.</p>	 <p>The screenshot shows the same menu as above, but "Show Contact Information" now has a status of "Yes" and is outlined in black. The "CHANGE" button has been replaced by "UPDATE", and "BACK" has been replaced by "CANCEL".</p>
<p>Using the UP and DOWN buttons select (highlighted in black) the "Change Contact Name" menu item.</p> <p>Press the Operational Button under "SELECT" to open the Change Contact Name menu.</p>	 <p>The screenshot shows "Change Contact Name" highlighted in black. The status of "Show Contact Information" is now "Yes". The "UPDATE" button has been replaced by "SELECT".</p>
<p>Follow the on screen instructions to enter your name or the name of your company. There is a maximum of 20 character spaces for this purpose.</p> <p>When finished press the Operational Button "UPDATE" to save the new Contact Name. The control system will return to the discrete menu.</p>	 <p>The screenshot shows a screen titled "Enter the service contact below:". It provides instructions: "Use the -> and <- keys to move between characters. Use the UP and DOWN keys to change the character." Below this is a text entry field labeled "NAME: _". At the bottom are buttons for "< -", "- >", and "UPDATE".</p>
<p>Using the UP and DOWN buttons select (highlighted in black) the "Change Contact Phone" menu item and press the Operational Button under "SELECT".</p> <p>Follow the on screen instructions to enter a new Contact Phone number and press the Operational Button under "UPDATE" to save the new phone number.</p> <p>When the new Contact Name and Contact Phone number have both been updated, press the Operational Button under "BACK" to return to the Desktop screen.</p>	 <p>The screenshot shows "Current Contact Info:" highlighted in black. The status of "Show Contact Information" is "Yes". The phone number is now "YOUR COMPANY NAME HERE (123) 456-7890". The "SELECT" button has been replaced by "BACK".</p>

FOR YOUR INFORMATION

START UP CONDITIONS

SMOKE/ODOR

It is not uncommon to experience a small amount of smoke and odor during the initial start-up. This is due to burning off of oil from metal parts, and will disappear in a short while.

THERMAL EXPANSION

CAUTION

Improper installation and use may result in property damage.

- Avoid water heater damage.
- Install thermal expansion tank or device if necessary.
- Contact qualified installer or service agency.

Water supply systems may, because of such events as high line pressure, frequent cut-offs, the effects of water hammer among others, have installed devices such as pressure reducing valves, check valves, back flow preventers, etc. to control these types of problems. When these devices are not equipped with an internal by pass, and no other measures are taken, the devices cause the water system to be closed. As water is heated, it expands (thermal expansion) and closed systems do not allow for the expansion of heated water.

The water within the water tank expands as it is heated and increases the pressure of the water system. If the relieving point of the water heater's temperature-pressure relief valve is reached, the valve will release excess pressure. The temperature-pressure relief valve is not intended for the constant relief of thermal expansion. This is an unacceptable condition and must be corrected. It is recommended that any devices installed which could create a closed system have a by-pass and/or the system have an expansion tank or device to relieve the pressure built by thermal expansion in the water system. Expansion tanks are available for ordering through a local plumbing contractor. Contact the local water heater supplier or qualified service agency for assistance in controlling these situations.

OPERATIONAL CONDITIONS

SMELLY WATER

In each water heater there is installed at least one anode rod (see Figure 1B and Figure 1C) for corrosion protection of the tank. Certain water conditions will cause a reaction between this rod and the water. The most common complaint associated with

the anode rod is one of a rotten egg smell in the hot water. The smell is a result of four factors which must all be present for the odor to develop:

- a. A concentration of sulfate in the supply water.
- b. Little or no dissolved oxygen in the water.
- c. A sulfate reducing bacteria which has accumulated within the water heater (this harmless bacteria is nontoxic to humans).
- d. An excess of active hydrogen in the tank. This is caused by the corrosion protective action of the anode rod.

Smelly water may be eliminated or reduced in some water heater models by replacing the anode rod(s) with one of less active material, and then chlorinating the water heater tank and all water lines. Contact the local water heater supplier or a qualified service agency for further information concerning an Anode Rod Replacement Kit and this chlorination treatment.

If the smelly water persists after the anode rod replacement and chlorination treatment, we can only suggest that chlorination or aeration of the water supply be considered to eliminate the water problem.

Do not remove the anode rod leaving the tank unprotected. By doing so, all warranty on the water heater tank is voided.

AIR IN HOT WATER FAUCETS

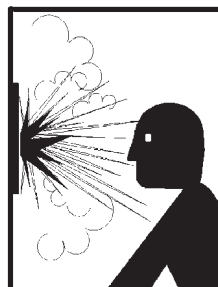

⚠ WARNING
Explosion Hazard
<ul style="list-style-type: none">• Flammable hydrogen gases may be present.• Keep all ignition sources away from faucet when turning on hot water.

HYDROGEN GAS: Hydrogen gas can be produced in a hot water system that has not been used for a long period of time (generally two weeks or more). Hydrogen gas is extremely flammable and explosive. To prevent the possibility of injury under these conditions, we recommend the hot water faucet, located farthest away, be opened for several minutes before any electrical appliances which are connected to the hot water system are used (such as a dishwasher or washing machine). If hydrogen gas is present, there will probably be an unusual sound similar to air escaping through the pipe as the hot water faucet is opened. There must be no smoking or open flame near the faucet at the time it is open.

PERIODIC MAINTENANCE

VENTING SYSTEM INSPECTION

! WARNING	
Breathing Hazard - Carbon Monoxide Gas	
	<ul style="list-style-type: none">• Flue gases may escape if vent pipe is not connected.• Be alert for obstructed, sooted or deteriorated vent system to avoid serious injury or death.• Do not store corrosive chemicals in vicinity of water heater.• Chemical corrosion of flue and vent system can cause serious injury or death.• Analyze the entire vent system to make sure that condensate will not become trapped in a section of vent pipe and therefore reduce the open cross sectional area of the vent.
Breathing carbon monoxide can cause brain damage or death. Always read and understand instruction manual.	

At least once a year examine the vent system. Points of inspection are as follows:

1. Check for obstructions and/or deterioration of the intake air and/or vent piping and the intake air and vent terminations. Replace immediately where needed.
2. The debris screens in the intake air and vent terminations should be cleaned of foreign material and soot.

NOTE: Do not reach inside the vent termination when the heater is in operation.

3. Check all vent system connections for leakage and repair or reseal as necessary.

Be sure the vent piping is properly connected to prevent escape of dangerous flue gasses which could cause deadly asphyxiation.

Obstructions and deteriorated vent systems may present serious health risk or asphyxiation.

Chemical vapor corrosion of the flue and vent system may occur if air for combustion contains certain chemical vapors. Spray can propellants, cleaning solvents, refrigerator and air conditioner refrigerants, swimming pool chemicals, calcium and sodium chloride, waxes, bleach and process chemicals are typical compounds which are potentially corrosive.

If after inspection of the vent system you found sooting or deterioration, something is wrong. Call the local gas utility to correct the problem and clean or replace the flue and venting before resuming operation of the water heater.

ANODE ROD INSPECTION

CAUTION	
Property Damage Hazard	
<ul style="list-style-type: none">• Avoid water heater damage.• Inspection and replacement of anode rod required.	

Each water heater contains at least one anode rod, which will slowly deplete (due to electrolysis) prolonging the life of the water heater

by protecting the glass-lined tank from corrosion. Adverse water quality, hotter water temperatures, high hot water usage, hydronic heating devices, and water softening methods can increase the rate of anode rod depletion. Once the anode rod is depleted, the tank will start to corrode, eventually developing a leak.

Certain water conditions will cause a reaction between the anode rod and the water. The most common complaint associated with the anode rod is a "rotten egg smell" produced from the presence of hydrogen sulfide gas dissolved in the water. **IMPORTANT:** Do not remove this rod permanently as it will void any warranties. A special anode rod may be available if water odor or discoloration occurs. **NOTE:** This rod may reduce but not eliminate water odor problems. The water supply system may require special filtration equipment from a water conditioning company to successfully eliminate all water odor problems.

Artificially softened water is exceedingly corrosive because the process substitutes sodium ions for magnesium and calcium ions.

The use of a water softener may decrease the life of the water heater tank.

The anode rod should be inspected after a maximum of three years and annually thereafter until the condition of the anode rod dictates its replacement. **NOTE:** artificially softened water requires the anode rod to be inspected annually.

The following are typical (but not all) signs of a depleted anode rod:

- * The majority of the rods diameter is less than 3/8".
- * Significant sections of the support wire (approx. 1/3 or more of the anode rod's length) are visible.

If the anode rod show signs of either or both it should be replaced.

NOTE: Whether re-installing or replacing the anode rod, check for any leaks and immediately correct if found.

In replacing the anode:

1. Turn off gas supply to the water heater.
2. Shut off the water supply and open a nearby hot water faucet to depressurize the water tank.
3. Drain approximately 5 gallons of water from tank (Refer to "Draining and Flushing" for proper procedures). Close drain valve.
4. Remove old anode rod.
5. Use Teflon® tape or approved pipe sealant on threads and install new anode rod.
6. Turn on water supply and open nearby hot water faucet to purge air from water system. Check for any leaks and immediately correct any if found.

Restart the water heater as directed.

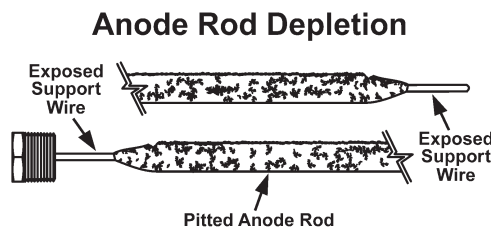

Figure 38

POWERED ANODE ROD (OPTIONAL MODELS)

To insure a long, trouble-free operating life, certain models of water heaters covered in this manual are factory equipped with a powered anode system. The anode rod is of a permanent design and does not need replacing unless damaged. Inspection and cleaning should be performed once a year.

NOTE: Follow the instructions to drain the water heater storage tank first. Remove the powered anodes from the water heater by loosening the 3/4" NPT bushing that forms the top of the anode rods. Do not disassemble the retaining nut and wire terminal from the top while installed in the water heater, the anode rods electrode may fall inside the tank. Remove the entire anode rod from the water heater prior to inspection. Clean the anode rod with a soft cloth and reinstall. Follow the instructions for filling the water heater when finished.

TEMPERATURE-PRESSURE RELIEF VALVE TEST

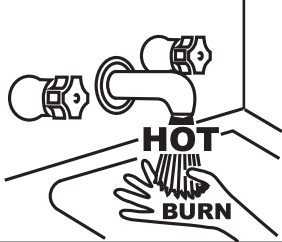
	⚠ DANGER
	<ul style="list-style-type: none">• Burn hazard.• Hot water discharge.• Keep clear of Temperature-Pressure Relief Valve discharge outlet.

It is recommended that the Temperature-Pressure Relief Valve should be checked to ensure that it is in operating condition every 6 months.

When checking the Temperature-Pressure Relief Valve operation, make sure that (1) no one is in front of or around the outlet of the Temperature-Pressure Relief Valve discharge line, and (2) that the water discharge will not cause any property damage, as the water may be extremely hot. Use care when operating valve as the valve may be hot.

To check the temperature-pressure relief valve, lift the lever at the end of the valve several times, Figure 39. The valve should seat properly and operate freely.

If after manually operating the valve, it fails to completely reset and continues to release water, immediately close the cold water inlet to the water heater and drain the water heater, see Draining and Flushing on page 49. Replace the Temperature-Pressure Relief Valve with a properly rated/sized new one, see Temperature-Pressure Relief Valve on Page 22 for instructions on replacement.

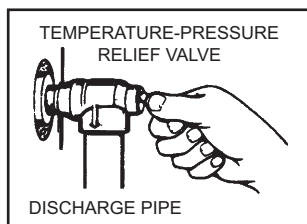

Figure 39

If the Temperature-Pressure Relief Valve on the water heater weeps or discharges periodically, this may be due to thermal expansion.

NOTE: Excessive water pressure is the most common cause of Temperature-Pressure Relief Valve leakage. Excessive water system pressure is most often caused by "thermal expansion" in a "closed system." See Closed Water Systems and Thermal Expansion on Page 21. The Temperature-Pressure Relief Valve is not intended for the constant relief of thermal expansion.

Temperature-Pressure Relief Valve leakage due to pressure build up in a closed system that does not have a thermal expansion tank installed is not covered under the limited warranty. Thermal expansion tanks must be installed on all closed water systems.

DO NOT PLUG THE TEMPERATURE-PRESSURE RELIEF VALVE OPENING. THIS CAN CAUSE PROPERTY DAMAGE, SERIOUS INJURY OR DEATH.

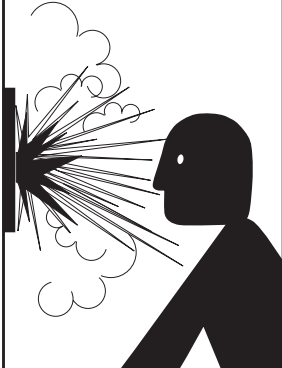
	⚠ WARNING
	Explosion Hazard <ul style="list-style-type: none">• Temperature-Pressure Relief Valve must comply with ANSI Z21.22-CSA 4.4 and ASME code.• Properly sized temperature-pressure relief valve must be installed in opening provided.• Can result in overheating and excessive tank pressure.• Can cause serious injury or death.

DRAINING AND FLUSHING

It is recommended that the water heater storage tank be drained and flushed every 6 months to reduce sediment buildup. The water heater should be drained if being shut down during freezing temperatures. See Figure 1B & Figure 1C in this manual for the location of the water heater components described below.

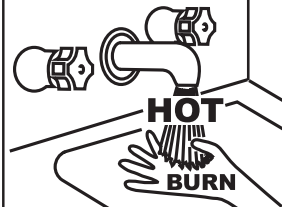
	⚠ DANGER
	<ul style="list-style-type: none">• Burn hazard.• Hot water discharge.• Keep hands clear of drain valve discharge.

TO DRAIN THE WATER HEATER STORAGE TANK:

1. Turn off the electrical supply to the water heater.
2. Turn off the gas supply at the Main Gas Shutoff Valve if the water heater is going to be shut down for an extended period.
3. Ensure the cold water inlet valve is open.
4. Open a nearby hot water faucet and let the water run until the water is no longer hot.
5. Close the cold water inlet valve to the water heater.
6. Connect a hose to the water heater drain valve and terminate it to an adequate drain.
7. Open the water heater drain valve and allow all the water to drain from the storage tank.
8. Close the water heater drain valve when all water in the storage tank has drained.
9. Close the hot water faucet opened in Step 4.
10. If the water heater is going to be shut down for an extended period, the drain valve should be left open.

TO FLUSH THE WATER HEATER STORAGE TANK:

1. Turn off the electrical supply to the water heater.
2. Ensure the cold water inlet valve is open.
3. Open a nearby hot water faucet and let the water run until the water is no longer hot. Then close the hot water faucet.
4. Connect a hose to the drain valve and terminate it to an adequate drain.
5. Ensure the drain hose is secured before and during the entire flushing procedure. Flushing is performed with system water pressure applied to the water heater.
6. Open the water heater drain valve to flush the storage tank.

7. Flush the water heater storage tank to remove sediment and allow the water to flow until it runs clean.
8. Close the water heater drain valve when flushing is completed.
9. Remove the drain hose.
10. Fill the water heater - see Filling The Water Heater in this manual.
11. Turn on the electrical supply to place the water heater back in operation.
12. Allow the water heater to complete several heating cycles to ensure it is operating properly.

SERVICE

If a condition persists or you are uncertain about the operation of the water heater contact a qualified service technician.

Use this guide to check a leaking water heater. Many suspected Leakers are not leaking tanks. Often the source of the water can be found and corrected.

If you are not thoroughly familiar with gas codes, your water heater, and safety practices, contact your gas supplier or qualified installer to check the water heater.

Read this manual first. Then before checking the water heater make sure the gas supply has been turned "OFF", and never turn the gas "ON" before the tank is completely full of water.

LEAKAGE CHECKPOINTS

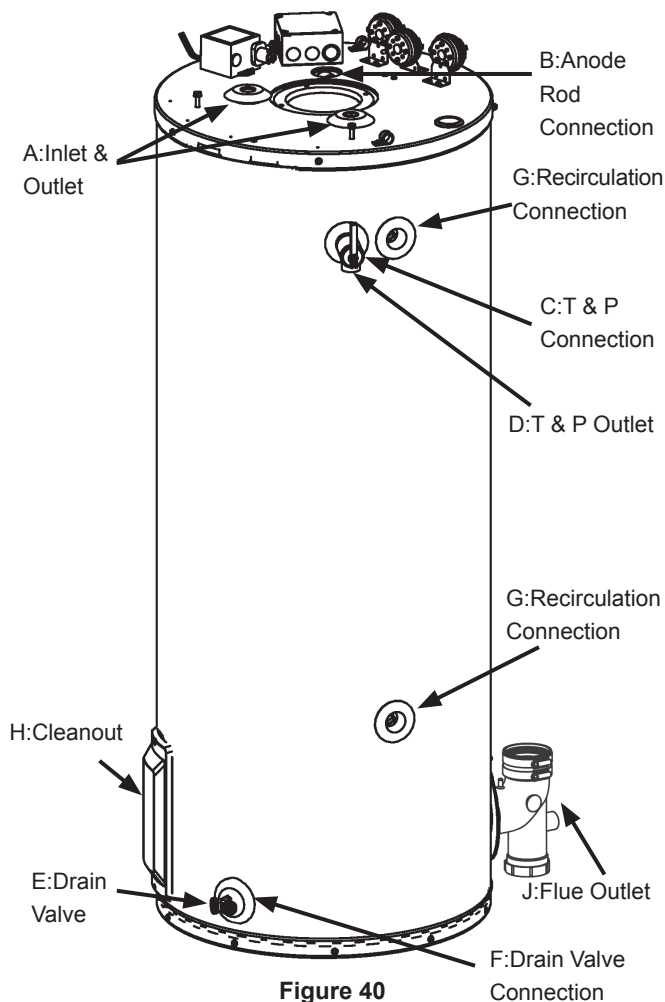

Figure 40

Never use this water heater unless it is completely filled with water. To prevent damage to the tank, the tank must be filled with water. Water must flow from the hot water faucet before turning "ON" gas to the water heater.

- A. *Condensation may be seen on pipes in humid weather or pipe connections may be leaking.
- B. *The anode rod fitting may be leaking.
- C. Small amounts of water from temperature-pressure relief valve may be due to thermal expansion or high water pressure in your area.
- D. *The temperature-pressure relief valve may be leaking at the tank fitting.
- E. Water from a drain valve may be due to the valve being slightly opened.
- F. *The drain valve may be leaking at the tank fitting.
- G. Leakage from recirculation plug or pipe connection.
- H. Leakage from the plug under the cleanout cover.
- I. Leakage from the temperature probe connection (Not shown in figure).
- J. Condensate from the exhaust connection.

Leakage from other water heaters, water lines, or ground seepage should also be checked.

- * To check where threaded portion enters tank, insert cotton swab between jacket opening and fitting. If cotton is wet, follow "Draining" instructions in the "Periodic Maintenance" section and then remove fitting. Put pipe dope or teflon tape on the threads and replace. Then follow "Filling the Water Heater" instructions in the "Installing the New Water Heater" section.

	⚠ WARNING
	Read and understand instruction manual and safety messages before installing, operating or servicing this water heater.
	Failure to follow instructions and safety messages could result in death or serious injury.
Instruction Manual must remain with water heater.	

TROUBLESHOOTING

INSTALLATION CHECKLIST

The list below represents some of the most critical installation requirements that, when overlooked, often result in operational problems, down time and needless parts replacement. This is not a complete list. Before performing any troubleshooting procedures use the list below to check for installation errors. Costs to correct installation errors are not covered under the limited warranty. Ensure all installation requirements and instructions in this manual have been maintained and followed.

WATER HEATER LOCATION

1. Ensure proper clearances to combustibles are maintained and there is sufficient room to service the water heater.
2. Ensure the area is free of corrosive elements and flammable materials.

VENTING

3. Ensure the intake air and/or vent (exhaust) piping is the correct size for the installed length.
4. Ensure the maximum equivalent feet of pipe has not been exceeded for the intake air and/or vent pipe.
5. Ensure the maximum number of elbows has not been exceeded in the intake air and/or vent pipe.
6. Ensure all exterior clearances for the intake air, vent and concentric terminations are maintained. These clearances and those cited by local and national codes must be maintained.
7. If venting direct vent, ensure the screen located in air intake at the water heater was removed.

GAS SUPPLY AND PIPING

8. Ensure the supply gas line to each water heater meets the minimum supply gas line size requirements.

CONDENSATE DRAIN

9. Ensure the condensate drain is properly connected to the exhaust elbow on the water heater and draining freely to a suitable floor drain.

ELECTRICAL CONNECTIONS

10. Ensure the water heater is properly grounded. Flame sensing requires an adequate earth ground. If the water heater is not properly grounded it will cause Ignition Failure.

SEQUENCE OF OPERATION

Read the Sequence of Operation below before attempting to correct any operational problems. See the Sequence Of Operation

Flow Chart.

1. When the control system is first powered, during boot up, the blower will run momentarily and stop, and the control system will display water heater model information during initialization. After a few moments the control system LCD which is part of the UIM (user interface module) will display the default screen known as the Desktop screen.
2. If the control system determines that the actual water temperature inside the tank is below the programmed Operating Set Point minus the Differential setting, a heating cycle is activated.
3. The control system then performs selected diagnostic system checks. This includes confirming the blocked exhaust, blocked intake and ECO (energy cut out) switch contacts are closed. The Blower Prover Switch contacts are confirmed open.
4. If all diagnostic checks are successfully passed, the control system energizes the Combustion Blower for pre-purge.
5. The control system must confirm the Blower Prover Switch contacts close after the Combustion Blower is energized.
6. If the Blower Prover Switch contacts are confirmed closed the control system energizes the spark igniter.
7. After a few seconds, the control system energizes the 24V Gas Control Valve allowing gas to flow to the Main Burner.
8. The control system monitors the flame sensor to confirm a flame is present at the Main Burner. If a flame is not verified during the ignition trial period the control system will try for ignition up to two more times. If flame can not be verified after three trials for ignition, the control system will lock out and display the Ignition Failure Fault message.
9. If a flame is verified, the control system will enter the heating mode where it will continue heating the water until the Operating Set Point is reached. At this point, the control system will de-energize the 24 V Gas Control Valve and enter the post-purge cycle (60 seconds).
10. The control system de-energizes the spark igniter.
11. The Combustion Blower will run for the duration of the post-purge cycle to purge the water heater of all combustion gases. When the post-purge cycle is complete, the blower is de-energized and will coast to a stop.
12. The control system now enters the standby mode while continuing to monitor the internal storage tank water temperature and the state of other system devices. If the tank temperature drops below the Operating Set Point minus the Differential setting, the control will automatically return to Step 2 and repeat the operating cycle.

SEQUENCE OF OPERATION FLOW CHART

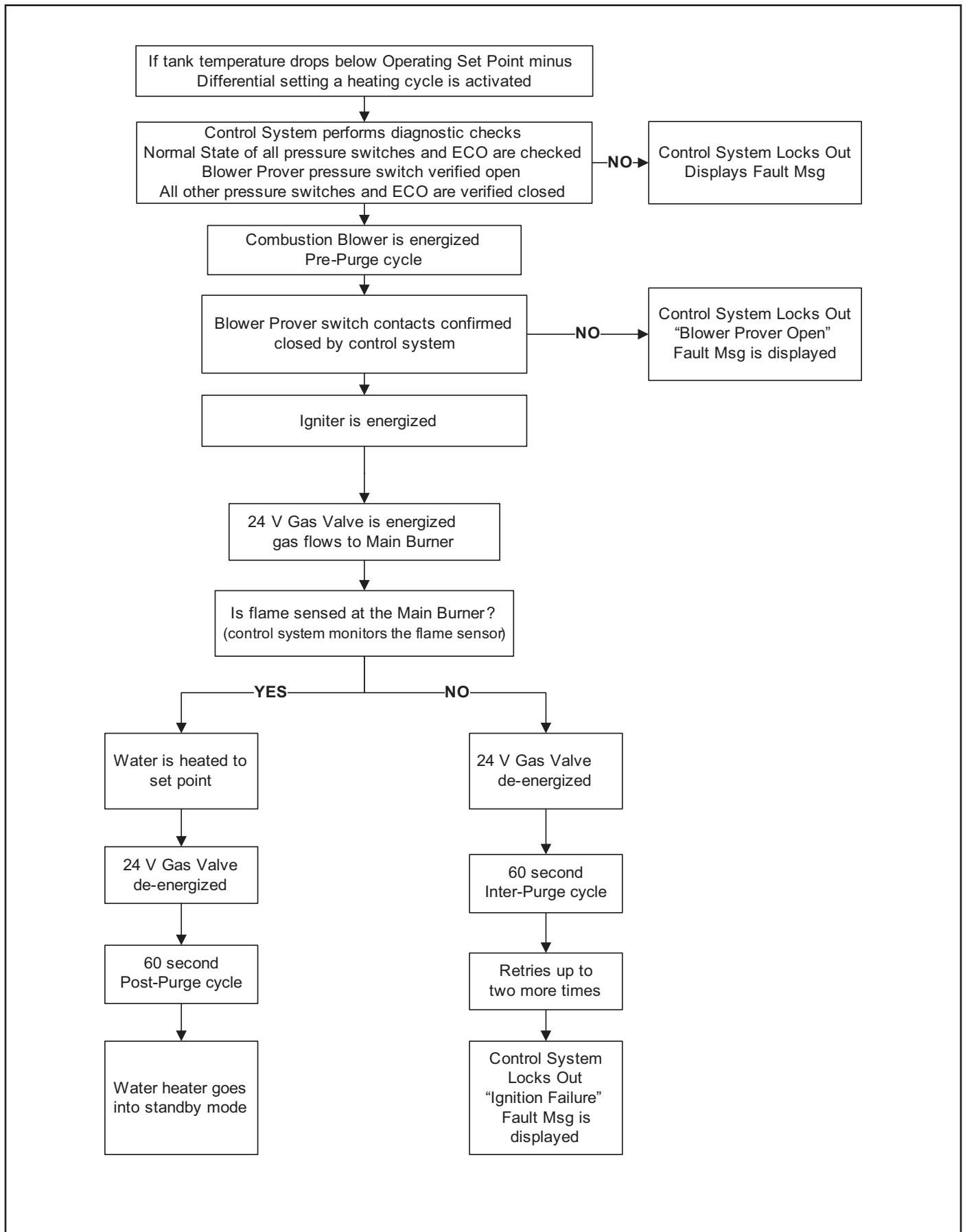



Figure 41



OPERATIONAL PROBLEMS

	 WARNING
	<p>Read and understand this instruction manual and the safety messages herein before installing, operating or servicing this water heater.</p>
	<p>Failure to follow these instructions and safety messages could result in death or serious injury.</p> <p>This manual must remain with the water heater.</p>

This section of the manual is intended to be an aid in correcting common operational problems, it is not all inclusive. The installer may be able to observe and correct certain problems which might arise when the water heater is first put into operation or when it is re-fired after a prolonged shutdown. However, only qualified service technician should perform any service procedures on the water heater.

NOTE: Call the technical support phone number listed on the back cover of this manual for further technical assistance or to locate a qualified service technician in your area.

ROUGH STARTING, ROUGH OPERATION

	 WARNING
	Fire and Explosion Hazard

- Do not use water heater with any gas other than the gas shown on the rating plate.
- Excessive gas pressure to gas valve can cause serious injury or death.
- Turn off gas lines during installation.
- Contact a qualified installer or service technician for installation and service.

- Undersized supply gas line (low volume of supply gas).
- Low Gas Pressure.
- Excessive supply gas pressure.
- Excessive manifold (offset) gas pressure.
- Incorrect Fuel Type
- Vent (exhaust) gas recirculation at the vent and intake air pipe terminations on Direct Vent installations.
- Excessive equivalent lengths of intake air and/or vent (exhaust) piping installed.
- Clogged/blocked intake air screen(s).
- Clogged/blocked the Main Burner.

MOMENTARY IGNITION

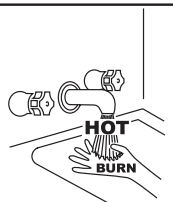
 CAUTION	
Burn Hazard	
	<ul style="list-style-type: none"> • The combustion chamber and burner sleeve and housing become very hot during operation. • Do not reach into the burner housing or combustion chamber if the water heater is still hot. • Allow the water heater to cool and always use gloves when handling the main burner.

If the Main Burner ignites momentarily but does not sustain ignition allow the water heater to try to ignite up to two more times until control system locks out and the Ignition Failure Fault message is displayed on the control system's LCD. If the water heater is experiencing rough starts - see Rough Starting, Rough Operation on this page. For momentary ignition problems without rough starting check the following:

- Incorrect manifold (offset) gas pressure.
- Undersized supply gas line (low volume of supply gas).
- Low Gas Pressure
- See the list of possible causes and things to check and repair for the Ignition Failure Fault message.
- Clogged/blocked intake air screen(s).
- Clogged/blocked Main Burner.

NOT ENOUGH OR NO HOT WATER

- No power to the water heater, check breaker, fuses.
- Enable/Disable switch in "disabled" position. Set to enable to allow unit to operate.
- Hot water supply valve(s) to fixtures closed.
- Operating Set Point is set too low, Differential setting is set too high.
- Temperature Probe Offset setting are causing the heating cycles to terminate prematurely.
- The heating capacity of the water heater has been exceeded, the water heater is unable to meet demand.
- Colder incoming water temperature lengthening the time required to heat water to desired temperature.
- Hot water piping leaks, open faucets, water heater drain valve leaking or open.
- Sediment or lime scale accumulation may be affecting water heater operation.

WATER IS TOO HOT

- Operating Set Point is set too high.
- Temperature Probe Offset settings improperly set.
- If installed check Thermostatic Mixing Valve settings.
- Lime build-up on temperature probes. Inspect and clean.

NOISY OPERATION

- Normal operating noise of electrical components; Combustion Blower, transformer hum, relay contact closure.

REPLACEMENT PARTS

Replacement parts may be ordered from the manufacturer, authorized service agencies or distributors. When ordering parts be sure to have the complete water heater Model Number, Serial Number and Series Number available. This information can be found on the rating plate affixed to the water heater.

For more information or technical support call the phone number(s) listed on the back cover of this manual.

FAULT AND ALERT CONDITIONS

FAULT CONDITIONS

When the control system declares a Fault condition it will display a Fault message on the control system's LCD with an exclamation "!" mark. The control system will lock out and disable heating operation until the condition is corrected. The water heater must be serviced by a qualified service technician before operation can be restored.

ALERT CONDITIONS

When the control system declares an Alert condition it will display an Alert message on the control system's LCD with a question "?" mark. The water heater will continue to operate during an Alert condition but the water heater must be serviced by a qualified service technician as soon as possible.

RESETTING CONTROL SYSTEM LOCK OUTS

To reset the control system from a lock out condition; turn off the switch in front of the unit for approximately 20 seconds and then back on. Keep in mind: if the condition that caused the Fault has not been corrected, the control system will continue to lock out.

DIAGNOSTIC CHECKS

WARNING

Electrical Shock Hazard

- Turn off power to the water heater before performing any service.
- Label all wires prior to disconnecting when performing service. Wiring errors can cause improper and dangerous operation.
- Verify proper operation after servicing.
- Failure to follow these instructions can result in personal injury or death.

The following section, Fault And Alert Messages lists some of the messages the control system will display on the LCD when there

are operational problems. This is not a complete list. Along with each of the Fault and Alert messages described there will be a list of possible causes and things to check and repair.

Only qualified service technician, as defined in Qualifications using appropriate test equipment, should perform any service procedures on the water heater.

NOTE: If you are not qualified and licensed or certified as required by the authority having jurisdiction to perform a given task do not attempt to perform any of the diagnostic or service procedures described in the following section.

If you do not understand the instructions in the following section do not attempt to perform any procedures.

Call the technical support phone number listed on the back cover of this manual for further technical assistance or to locate a qualified service technician in your area.

WARNING

Jumping out control circuits or components can result in property damage, personal injury or death.

- Service should only be performed by a qualified service technician using proper test equipment.
- Altering the water heater controls and/or wiring in any way could result in permanent damage to the controls or water heater and is not covered under the limited warranty.

Any bypass or alteration of the water heater controls and/or wiring will result in voiding the appliance warranty.

FAULT AND ALERT MESSAGES

Call the technical support phone number listed on the back cover for further technical assistance or to locate a qualified service technician in your area.

POSSIBLE CAUSES - CHECK/REPAIR	DISPLAYED FAULT/ALERT MESSAGE
<ul style="list-style-type: none"> Using a manometer, ensure that gas supply pressure is above minimum requirement listed on heater's data plate and does not drop more than 1.5"W.C. when unit fires. Ensure wire connections to gas valve are clean and tight. Ensure wire connections to flame sensor are clean and tight. Ensure wire connections to spark igniter are clean and tight. Inspect flame sensor, clean/replace as needed. Inspect spark igniter, realign igniter gap as needed. Ensure adequate electrical ground to heater. 	<div style="border: 1px solid black; padding: 10px; text-align: center;"> <h3 style="margin: 0;">Ignition Failure</h3> <p style="font-size: small; margin: 0;">Fault occurred 2 mins ago</p> <div style="display: flex; align-items: center; justify-content: space-between;"> <div style="text-align: left; padding-right: 10px;"> <p style="margin: 0;">Flame not detected. Clean flame rod. Check gas supply.</p> <p style="margin: 0;">Call a service professional: Your Company Name Here (press [DOWN] for more....)</p> </div> </div> <div style="display: flex; justify-content: center; margin-top: 5px;"> BACK ADVANCED </div> </div>
<ul style="list-style-type: none"> If Blocked Exhaust error occurs when blower is running, check for restrictions in exhaust pipe, including exhaust elbow, condensate drain, and outside termination. Also check exhaust pipe installation (size/length) per manual. If Blocked Exhaust error occurs before blower runs, make sure pressure switch connections are clean and tight. Check pressure switch continuity/resistance. Switch should be closed (continuity/0 ohms). Replace switch if open (no continuity). Other possible causes: high wind conditions and excessive negative air pressure in building. 	<div style="border: 1px solid black; padding: 10px; text-align: center;"> <h3 style="margin: 0;">Blocked Exhaust</h3> <p style="font-size: small; margin: 0;">Fault occurred 2 mins ago</p> <div style="display: flex; align-items: center; justify-content: space-between;"> <div style="text-align: left; padding-right: 10px;"> <p style="margin: 0;">Restriction in exhaust pipe. Check exhaust pipe and termination for blockage.</p> <p style="margin: 0;">Call a service professional: Your Company Name Here (press [DOWN] for more....)</p> </div> </div> <div style="display: flex; justify-content: center; margin-top: 5px;"> BACK ADVANCED </div> </div>

FAULT AND ALERT MESSAGES (CONT)

Call the technical support phone number listed on the back cover for further technical assistance or to locate a qualified service technician in your area.

POSSIBLE CAUSES - CHECK/REPAIR	DISPLAYED FAULT/ALERT MESSAGE
<ul style="list-style-type: none"> • Ensure excessive wind is not pressurizing the intake air or exhaust pipe. • Confirm wire connections of the blower prover switch are clean, tight, and not jumped/shorted. • Use multi-meter to check continuity/resistance of blower prover pressure switch. Switch should be open (no continuity) when blower is not operating. Replace switch if contacts are closed when blower is off. 	<div style="border: 1px solid black; padding: 5px;"> <p style="text-align: center;">Blower Operation Error</p> <p style="text-align: center; font-size: small;">Fault occurred 2 mins ago</p> <div style="display: flex; justify-content: space-between; align-items: center;"> <div style="text-align: center;"> <p>The blower prover switch is closed out of sequence.</p> </div> </div> <div style="text-align: center; margin-top: 10px;"> <p>Call a service professional: Your Company Name Here (press [DOWN] for more....)</p> </div> <div style="display: flex; justify-content: space-between; border-top: 1px solid black; padding-top: 5px;"> BACK ADVANCED </div> </div>
<ul style="list-style-type: none"> • Confirm that blower runs during a call for heat. • If blower runs, confirm sensing tube is connected and clear of obstructions, blower port for sensing tube is clear of obstructions, and wire connections for blower prover switch are clean and tight. • If all above conditions are met, replace pressure switch. 	<div style="border: 1px solid black; padding: 5px;"> <p style="text-align: center;">Blower Prover Open</p> <p style="text-align: center; font-size: small;">Fault occurred 2 mins ago</p> <div style="display: flex; justify-content: space-between; align-items: center;"> <div style="text-align: center;"> <p>The blower prover switch remains open after the blower has been energized.</p> </div> </div> <div style="text-align: center; margin-top: 10px;"> <p>Call a service professional: Your Company Name Here (press [DOWN] for more....)</p> </div> <div style="display: flex; justify-content: space-between; border-top: 1px solid black; padding-top: 5px;"> BACK ADVANCED </div> </div>
<ul style="list-style-type: none"> • If Blocked Intake error occurs before blower runs, make sure pressure switch connections are clean and tight. Check pressure switch continuity/resistance. Switch should be closed (continuity/0 ohms). Replace switch if open (no continuity). • If Blocked Intake error occurs when blower is running, check for restrictions in intake pipe, including intake air connection, outside termination, and inlet condensate drains (if installed). • Other possible causes: High wind conditions, excessive negative air pressure in building. 	<div style="border: 1px solid black; padding: 5px;"> <p style="text-align: center;">Blocked Air Intake</p> <p style="text-align: center; font-size: small;">Fault occurred 2 mins ago</p> <div style="display: flex; justify-content: space-between; align-items: center;"> <div style="text-align: center;"> <p>Restriction in air intake. Check intake pipe and termination for blockage.</p> </div> </div> <div style="text-align: center; margin-top: 10px;"> <p>Call a service professional: Your Company Name Here (press [DOWN] for more....)</p> </div> <div style="display: flex; justify-content: space-between; border-top: 1px solid black; padding-top: 5px;"> BACK ADVANCED </div> </div>
<ul style="list-style-type: none"> • Ensure wire connections to upper temperature probe are clean and tight. • Using a thermometer, check the water temperature of the heater. • Use a multi-meter and check for continuity between the two red wires of the upper temperature probe. • If the two red wires are open (no continuity) and water temperature is below 160°F, replace upper temperature probe. • If the water temperature exceeds 195°F, turn off electric power and gas supply and call Tech Support for further instructions. 	<div style="border: 1px solid black; padding: 5px;"> <p style="text-align: center;">Energy Cut Out (ECO)</p> <p style="text-align: center; font-size: small;">Fault occurred 2 mins ago</p> <div style="display: flex; justify-content: space-between; align-items: center;"> <div style="text-align: center;"> <p>Tank temperature is excessive. The water heater has been disabled.</p> </div> </div> <div style="text-align: center; margin-top: 10px;"> <p>Call a service professional: Your Company Name Here (press [DOWN] for more....)</p> </div> <div style="display: flex; justify-content: space-between; border-top: 1px solid black; padding-top: 5px;"> BACK ADVANCED </div> </div>
<ul style="list-style-type: none"> • Confirm the water heater is full of water. • Confirm the powered anode wire connections are tight and free of debris or moisture (i.e. rust, solder, metal pipe shavings). • Confirm proper electrical ground to the water heater. <p style="font-size: small; margin-top: 10px;">* Applies to models with powered anode option.</p>	<div style="border: 1px solid black; padding: 5px;"> <p style="text-align: center;">Alert: No Water</p> <p style="text-align: center; font-size: small;">Alert occurred 2 mins ago</p> <div style="display: flex; justify-content: space-between; align-items: center;"> <div style="text-align: center;"> <p>No water detected by Powered anode.</p> </div> </div> <div style="text-align: center; margin-top: 10px;"> <p>Call a service professional: Your Company Name Here (press [DOWN] for more....)</p> </div> <div style="display: flex; justify-content: space-between; border-top: 1px solid black; padding-top: 5px;"> BACK ADVANCED </div> </div>

WIRING DIAGRAM



LABEL ALL WIRES PRIOR TO DISCONNECTION WHEN SERVICING CONTROLS. WIRING ERRORS CAN CAUSE IMPROPER AND DANGEROUS OPERATION. VERIFY PROPER OPERATION AFTER SERVICING.

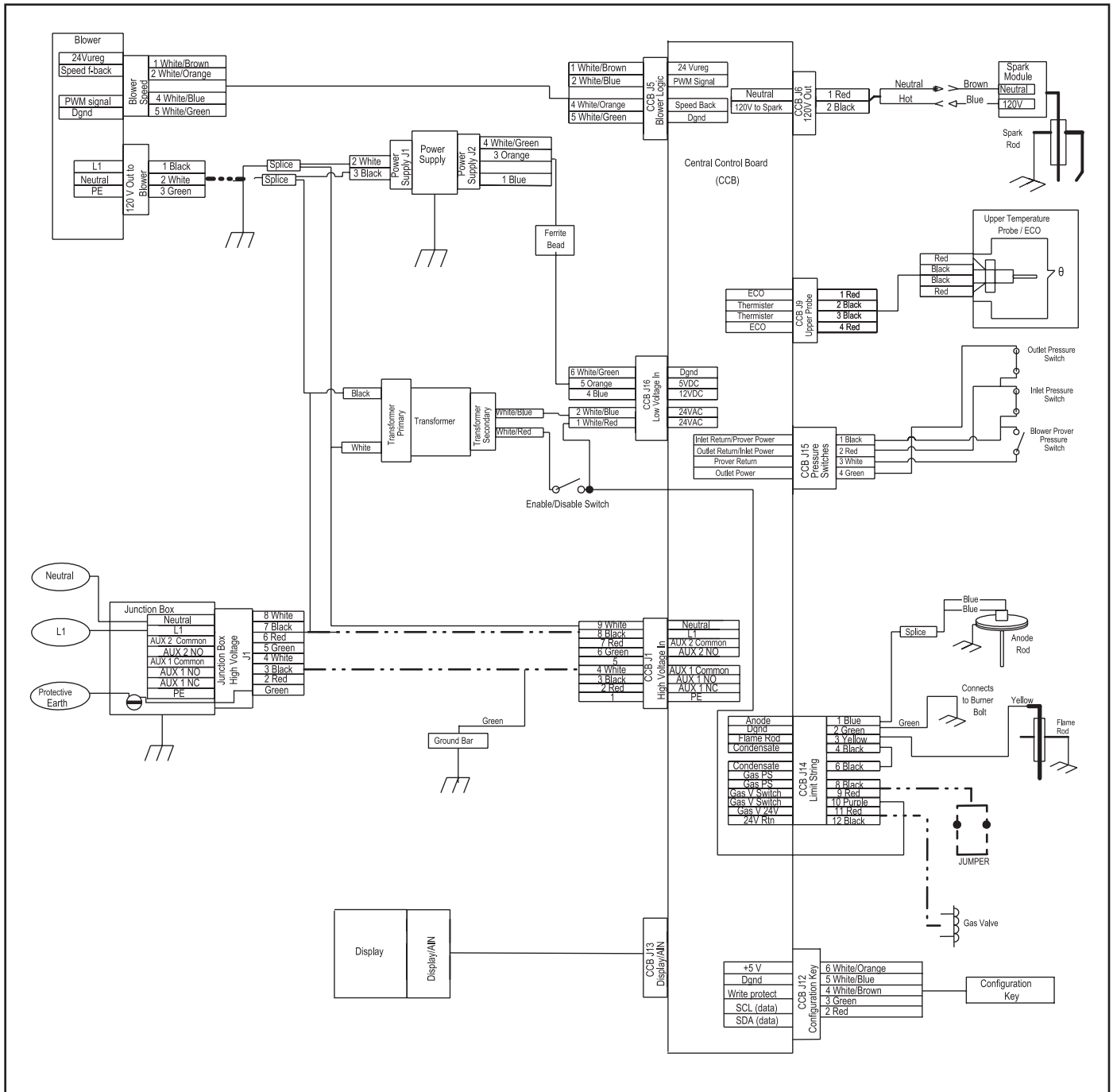

WARNING

DISCONNECT FROM ELECTRICAL SUPPLY BEFORE SERVICING UNIT.
REPLACE ALL DOORS AND PANELS BEFORE OPERATING HEATER.

IF ANY OF THE ORIGINAL WIRES SUPPLIED WITH THE APPLIANCE MUST BE REPLACED, IT MUST BE REPLACED WITH APPLIANCE WIRE MATERIAL WITH MINIMUM TEMPERATURE RATING OF 105°C AND A MINIMUM SIZE OF NO. 18 AWG.

Figure 42: WIRING SCHEMATIC

NOTES

COMMERCIAL WATER HEATER LIMITED WARRANTY



EFFECTIVE

For 3 Years, in the event of a tank leak, we will repair or, at our discretion, replace the defective water heater.

For 1 Year, in the event of part failure, we will repair or, at our discretion, replace the defective part.

We warrant this product against defects in materials or workmanship as described in this document if installed within the United States or Canada and provided the product remains at its original place of installation.

Warranty coverage begins the date of installation OR the date of manufacture if installation cannot be verified.

WHAT'S COVERED

Subject to these terms, in the event of defect in materials and/or workmanship resulting in a **tank leak** during the **first three years**, we will:

- Replace the water heater should the tank leak.

Subject to these terms, in the event of a defect in materials and/or workmanship appearing during the **first year**, we will:

- Repair or, at our discretion, replace any part of the water heater covered under this limited warranty excluding parts subject to normal maintenance (Example: non-electronic anode rod, filter, etc)

Service/labor, shipping, delivery, installation, handling or any other costs are not covered at any time under this warranty.

Any replacement part or product will be warranted only for the unexpired portion of the original water heater's limited warranty period.

If an identical model is no longer available due to a change in law, regulation, or standard, we will replace the product with one having comparable capacity and input. In these instances, the owner will have the option of paying the difference between what was paid for the original model and the new model with the additional features, or receiving a refund of the portion of the purchase price, on a pro-rata basis allocable to the unexpired portion of the warranty.

WHAT'S NOT COVERED

- Problems caused by improper: gas supply line sizing, gas type, venting, connections, combustion air, voltage, wiring, or fusing
- Failure to follow applicable codes
- Failure to follow printed instructions
- Abuse, misuse, accident, fire, flood, Acts of God
- Improper installation, sizing, delivery, or maintenance
- Claims related to rust, noise, smell, or taste of water
- Failure to conduct authorized factory start up if required
- Alterations to the water heater
- Non-outdoor heaters installed outdoors
- Damages due to a failure to allow for thermal expansion
- Heat exchanger failure due to lack of adequate / proper supply of water
- Heaters moved from their original location
- Service trips to explain proper installation, use, or maintenance of the product/unit or to describe compliance requirements under applicable codes and regulations
- Charges related to accessing your heater including but not limited to door/wall removal, equipment rental, etc.
- Replacement parts after expiration of this warranty

LIMITATIONS

NOTWITHSTANDING ANYTHING ELSE TO THE CONTRARY, THIS IS YOUR SOLE AND EXCLUSIVE WARRANTY. ALL OTHER WARRANTIES INCLUDING A WARRANTY OF MERCHANTABILITY OR FITNESS FOR PARTICULAR PURPOSE ARE EXPRESSLY DISCLAIMED. SELLER SHALL NOT BE LIABLE FOR ANY CONSEQUENTIAL, INCIDENTAL, SPECIAL, PUNITIVE OR OTHER INDIRECT DAMAGES. TOTAL LIABILITY ARISING AT ANY TIME SHALL NOT EXCEED THE PURCHASE PRICE PAID WHETHER BASED ON CONTRACT, TORT, STRICT LIABILITY OR ANY OTHER LEGAL THEORY.

SERVICE INQUIRIES:

For service inquiries call the telephone number listed below. Be prepared to provide the following information: name, address, and telephone number; the model and serial number of the water heater; proof of installation; and a clear description of the problem.

For your records, fill in the product:

Serial: _____

Model: _____

U.S. Customers:

A. O. Smith Corporation
500 Tennessee Waltz Parkway
Ashland City, Tennessee 37015
800-527-1953
www.hotwater.com

Canadian Customers:

P. O. Box 310 – 768 Erie Street
Stratford (Ontario) N5A 6T3
800-265-8520



www.hotwater.com

500 Tennessee Waltz Parkway, Ashland City, TN 37015

Tech Support: 800-527-1953

Parts: 800-433-2545

Copyright © 2014 A. O. Smith Corporation, All rights reserved.