

GAS FIRED COMMERCIAL COPPER BOILERS

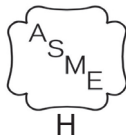

25589, Highway 1
McBee, SC 29101



**MODELS: HW
300, 399, 420, 520, 670
FOR HOT WATER SUPPLY
UP - FLOW MODELS
OPERATION - MAINTENANCE -
LIMITED WARRANTY**

WARNING: If the information in these instructions is not followed exactly, a fire or explosion may result causing property damage, personal injury or death.

- Do not store or use gasoline or other flammable vapors and liquids in the vicinity of this or any other appliance.
- **WHAT TO DO IF YOU SMELL GAS:**
 - Do not try to light any appliance.
 - Do not touch any electrical switch; do not use any phone in your building.
 - Immediately call your gas supplier from a neighbor's phone. Follow the gas supplier's instructions.
 - If you cannot reach your gas supplier, call the fire department.
- Installation and service must be performed by a qualified installer, service agency or the gas supplier.

Thank you for buying this energy efficient boiler.
We appreciate your confidence in our products.



⚠ WARNING

Read and understand this manual and all Warnings and Cautions within before installing and using this boiler.

Place these instructions adjacent to boiler and notify owner to keep for future reference.

TABLE OF CONTENTS





TABLE OF CONTENTS.....	2
SAFE INSTALLATION, USE AND SERVICE.....	3
GENERAL SAFETY.....	4
INTRODUCTION.....	5
Abbreviations used.....	5
Qualifications.....	5
CONTROL COMPONENTS.....	6
BOILER START UP AND OPERATIONS.....	10
Filling the system.....	10
Precautions.....	10
Pilot and main burner.....	10
Checking and adjusting input.....	12
TROUBLESHOOTING.....	16
MAINTENANCE PROCEDURES.....	24
Manual reset high limit switch continuity test.....	24
Pressure relief valve test.....	24
Cleaning and flushing instructions.....	24
Venting maintenance.....	25
NOTES.....	26
LIMITED WARRANTY.....	27

SAFE INSTALLATION, USE AND SERVICE

The proper installation, use and servicing of this boiler is extremely important to your safety and the safety of others.

Many safety-related messages and instructions have been provided in this manual and on your boiler to warn you and others of a potential injury hazard. Read and obey all safety messages and instructions throughout this manual. It is very important that the meaning of each safety message is understood by you and others who install, use, or service this boiler.

	<p>This is the safety alert symbol. It is used to alert you to potential personal injury hazards. Obey all safety messages that follow this symbol to avoid possible injury or death.</p>
---	---

	<p>DANGER indicates an imminently hazardous situation which, if not avoided, will result in injury or death.</p>
	<p>WARNING indicates a potentially hazardous situation which, if not avoided, could result in injury or death.</p>
	<p>CAUTION indicates a potentially hazardous situation which, if not avoided, could result in minor or moderate injury.</p>
	<p>CAUTION used without the safety alert symbol indicates a potentially hazardous situation which, if not avoided, could result in property damage.</p>

All safety messages will generally tell you about the type of hazard, what can happen if you do not follow the safety message, and how to avoid the risk of injury.

IMPORTANT DEFINITIONS

Gas Supplier: The Natural Gas or Propane Utility or service who supplies gas for utilization by the gas burning appliances within this application. The gas supplier typically has responsibility for the inspection and code approval of gas piping up to and including the Natural Gas meter or Propane storage tank of a building. Many gas suppliers also offer service and inspection of appliances within the building.

APPROVALS

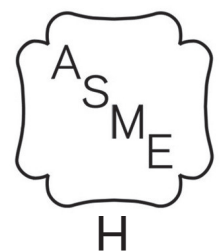

GENERAL SAFETY



⚠ WARNING

Read and understand this manual and all Warnings and Cautions within before installing and using this appliance.

Place these instructions adjacent to boiler and notify owner to keep for future reference.

⚠ DANGER

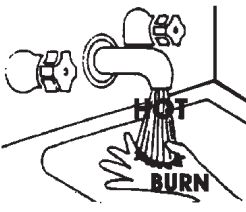

Untempered hot water can cause severe burns instantly resulting in severe injury or death.

Children, elderly, and the physically or mentally disabled are at highest risk for scald injury.

Feel water before bathing or showering. Temperature limiting valves are available.

Read instruction manual for safe temperature setting.



⚠ DANGER

Fire or Explosion Hazard

- Do not store or use gasoline or other flammable vapors and liquids in the vicinity of this or any other appliance.
- Avoid all ignition sources if you smell LP gas.
- Do not expose boiler control to excessive gas pressure.
- Use only gas shown on rating plate.
- Maintain required clearances to combustibles.
- Keep ignition sources away from faucets after extended period of non-use.



Read instruction manual before installing, using or servicing.



⚠ WARNING

Fire Hazard

For continued protection against risk of fire:

- Do not install boiler on carpeted floor.
- Do not operate boiler if flood damaged.

⚠ DANGER

Fire or Explosion Hazard

- Do not store or use gasoline or other flammable vapors and liquids in the vicinity of this or any other appliance.



FLAMMABLE

Flammable Vapors

⚠ WARNING

Explosion Hazard

- Overheated water can cause water tank explosion.
- Properly sized temperature and pressure relief valve must be installed.

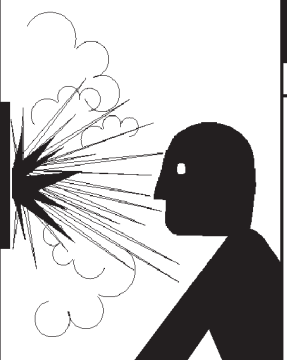

⚠ WARNING

Breathing Hazard - Carbon Monoxide Gas

- Special consideration must be taken with installations above 2,000 feet.
- Please contact an A. O. Smith qualified service agent to obtain the proper setup and instructions before lighting.
- Failure to implement the proper setup will result in improper and inefficient operation of the appliance resulting in production of increased levels of carbon monoxide gas in excess of the safe limits which could result in serious personal injury or death.



Breathing carbon monoxide can cause brain damage or death. Always read and understand instruction manual.

CAUTION

Improper installation and use may result in property damage.

- Do not operate boiler if flood damaged.
- Install in location with drainage.
- Fill boiler with water before operation.
- Be alert for thermal expansion.

Refer to instruction manual for installation and service.

INTRODUCTION

This design complies with the current edition of the ANSI Z21.13 low-pressure boiler standard.

Compliance under this standard implies that when the boiler underwent test, the gas manifold and control assembly provided on the boiler met safe lighting and other performance criteria.

Detailed installation diagrams are found in this manual. These diagrams will serve to provide the installer a reference for the materials and methods of piping necessary. It is essential that all water, gas piping and wiring be installed as shown on the diagrams. You should thoroughly read and understand this manual before installation and/or operation of this boiler.

The factory warranty will be void if the boiler(s) have been improperly installed or operated.

In addition to these instructions, the boiler(s) shall be installed in accordance with those installation regulations in force in the local area where the installation is to be made. These shall be carefully followed in all cases. Authorities having jurisdiction should be consulted before installations are made.

In the absence of local codes, the installation must comply with the current editions, as follows:

In the United States:

The National Fuel Gas Code, ANSI Z223.1/NFPA 54 and the National Electric Code, NFPA 70.

In Canada:

Installation Code CAN/CSA B149.1 and Canadian Electrical Code, CSA C22.1.

ABBREVIATIONS USED

Abbreviations found in this Instruction Manual include :

- ANSI - American National Standards Institute
- ASME - American Society of Mechanical Engineers
- NEC - National Electrical Code
- NFPA - National Fire Protection Association
- UL - Underwriters Laboratory
- CSA - Canadian Standards Association

QUALIFICATIONS

QUALIFIED INSTALLER OR SERVICE AGENCY

Installation and service of this boiler requires ability equivalent to that of a Qualified Agency, as defined by ANSI below. In the field involved. Installation skills such as plumbing, air supply, venting, gas supply and electrical supply are required in addition to electrical testing skills when performing service.

ANSI Z21.13 - CSA 4.9: "Qualified Agency" - "Any individual, firm, corporation or company that either in person or through a representative is engaged in and is responsible for (a) the installation, testing or replacement of gas piping or (b) the connection, installation, testing, repair or servicing of appliances and equipment; that is experienced in such work; that is familiar with all precautions required; and that has complied with all the requirements of the authority having jurisdiction."

If you are not qualified (as defined by ANSI above) and licensed or certified as required by the authority having jurisdiction to perform a given task do not attempt to perform any of the procedures described in this manual. If you do not understand the instructions given in this manual do not attempt to perform any procedures outlined in this manual.

CONTROL COMPONENTS

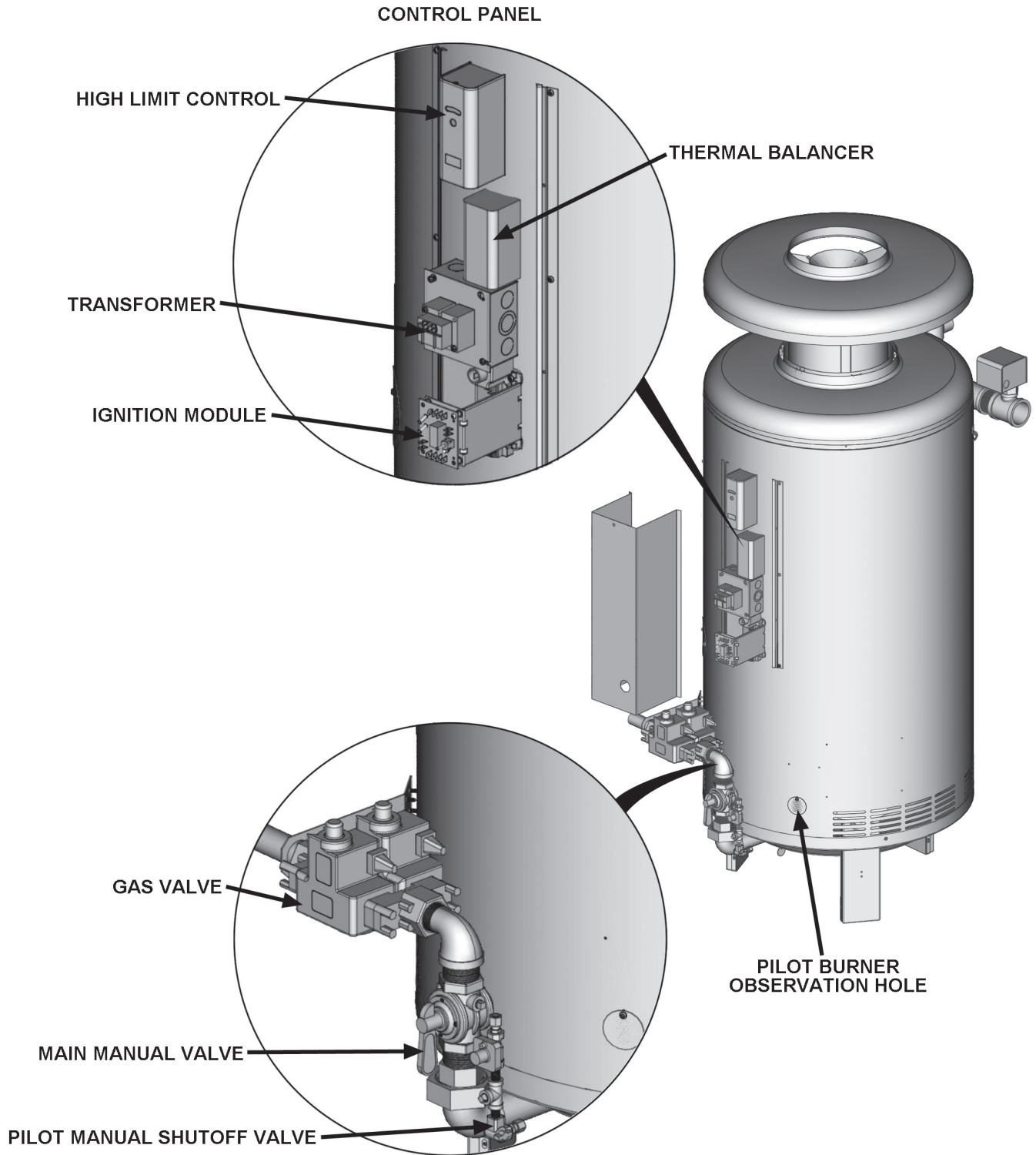

FIGURE 1. COMPONENT LOCATIONS

AUTO RESET HIGH LIMIT

The high limit is a safety device wired in series with the ignition system. Set the high limit control to approximately 100°F above the maximum designed system temperature. If the boiler outlet water temperature should exceed the high limit setting, the main gas control valve will close but the circulating pump will continue to operate. Maximum adjustable setting is 115°C (239°F) cut-out with a 30°C (86°F) to 250°C (482°F) adjustable differential, see Figure 2.

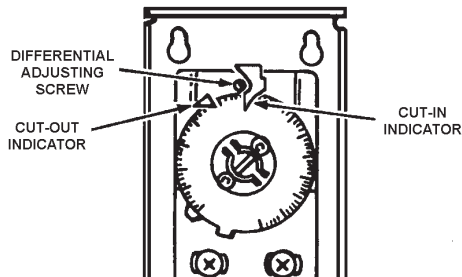

FIGURE 2. AUTO RESET HIGH LIMIT

INTERMITTENT IGNITION CONTROL MODULE

The Honeywell S-8600 control module contains the electronic components of the system and also serves as a control wiring system for the controls mounted on the boiler. The control module performs the following functions:

1. Checks for safe-start by sensing for a false flame condition on start-up.
2. Generates a potential of 15,000 volts for spark ignition of the pilot burner.
3. Opens the pilot valve.
4. Discontinues ignition spark when the pilot flame is established. The S-8600 control used on propane gas models provides safety lockout if the pilot fails to ignite within the pilot flame establishing period. The S-8600 control used on natural gas models continues trial for ignition until pilot flame is established.
5. After proof of pilot flame, opens then main valve.
6. On a power loss, shuts the boiler down. When power is restored it will begin a new ignition cycle.
7. On a loss of flame, shuts off main gas and starts trial for pilot ignition.

Please refer to Troubleshooting section for more information.

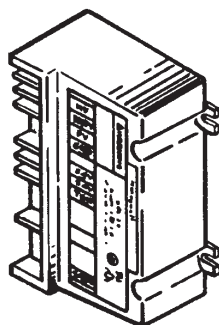

FIGURE 3. S-8600 INTERMITTENT IGNITION CONTROL MODULE (IID)

THERMAL BALANCER

Figure 4 shows the internal wiring of the thermal balancer. The device may be tested after disconnecting the four leads from their respective terminals on the unit.

1. Apply a test light to the yellow and red leads.
 - The lamp should light as the contact in this circuit is normally closed when the resistor is cool.
2. Apply a light to the black and yellow leads.
 - The lamp should not light as the contact in this circuit is normally open when the resistor is cool.
3. Remove the test light.
4. Apply 120 volts to the white and red leads which power the 1900 ohm resistor. After a warming period the contacts of the thermal balancer should operate.
5. Remove the test light.
6. Apply the test light as described in steps 1 and 2.

While the resistor is still warm the lamp indications should be the opposite as described previously.

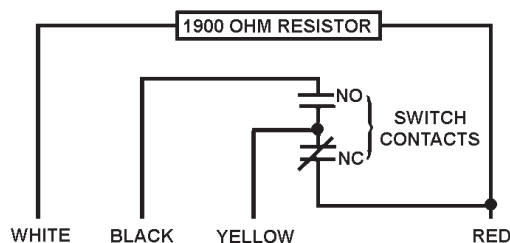

FIGURE 4. THERMAL BALANCER

MANUAL RESET HIGH LIMIT

This boiler is equipped with a manual reset high limit switch, located under the small cover on the side of the jacket, see Figure 5. This device provides positive shutdown of the boiler in the event of boiler or system malfunction. Should the surface temperature of the copper tubing heat exchanger reach 250°F (120°C), the high limit switch will activate, the gas control valve will close, the pilot and main burners will be extinguished. If the high limit switch should shut off unit, check the following conditions:

- No water in boiler.
- Restricted water flow through the boiler.
- Improper wiring (boiler firing without circulating pump operating).
- Pump failure.

After correcting failure condition remove the protector switch cover and push the reset button. The high limit switch may be reset after the coil surface cools to 6°F (3.3°C) below the trip setting.

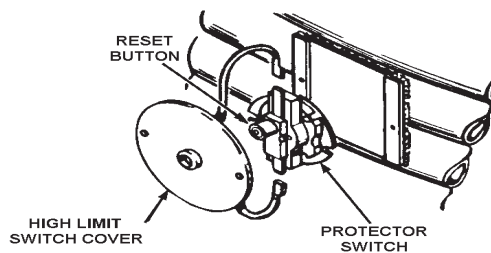
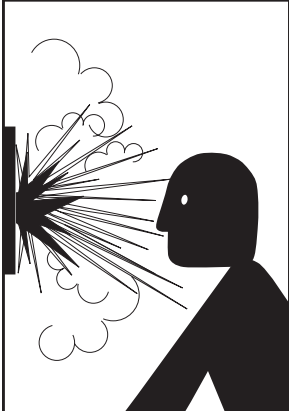

FIGURE 5. HIGH LIMIT SWITCH

PRESSURE RELIEF VALVE

An ASME rated pressure relief valve is furnished with the boiler. A fitting for the pressure relief valve is provided in the top of the boiler. Never operate the heating elements without being certain the boiler is filled with water and a properly sized pressure relief valve is installed in the pressure relief valve opening provided.

The pressure rating of the pressure relief valve should be equal to or less than the rated pressure capacity of any component in the system including the boiler. Should the valve need to be replaced, call the toll free phone number listed on the back of this manual for further technical assistance.

	⚠ WARNING
	Explosion Hazard
	<ul style="list-style-type: none">• Pressure Relief Valve must comply with ASME code.• Properly sized Pressure Relief Valve must be installed in opening provided.• Can result in overheating and excessive tank pressure.• Can cause serious injury or death.

A discharge pipe from the pressure relief valve should terminate at an adequate floor drain. Do not thread, plug, or cap the end of the drain line.

CAUTION
Water Damage Hazard
<ul style="list-style-type: none">• Pressure Relief Valve discharge pipe must terminate at adequate drain.

The Discharge Pipe:

- Shall not be smaller in size than the outlet pipe size of the valve, or have any reducing couplings or other restrictions.
- Shall not be plugged or blocked.
- Shall not be exposed to freezing temperatures.
- Shall be of material listed for hot water distribution.
- Shall be installed so as to allow complete drainage of both the pressure relief valve and the discharge pipe.
- Must terminate a maximum of six inches above a floor drain or external to the building. In cold climates, it is recommended that the discharge pipe be terminated at an adequate drain inside the building.
- Shall not have any valve or other obstruction between the pressure relief valve and the drain.

Once the boiler is installed and filled with water and the system is pressurized, manually test the operation of the pressure relief valve.

If any pressure relief valve is replaced, the replacement valve must comply with the current editions of the ASME Boiler and Pressure Vessel Code, Section IV or CSA B51, as applicable. Select a pressure relief valve with a discharge NOT less than the boiler input, and a pressure rating NOT exceeding the working pressure of any component in the system.

A. O. Smith supplies a 125 psi pressure relief valve for hot water supply systems and 50 psi pressure relief valve for space heating application.

An ASME rated temperature and pressure relief valve must be installed on each and every water storage tank in a hot water supply system.

The storage tank temperature and pressure (T & P) relief valve must comply with the applicable construction provisions of the Standard for Relief valves and Automatic Gas Shutoff Devices for Hot Water Supply Systems, Z21.22 - CSA 4.4. The T & P valve must be of the automatic reset type and not embody a single-use type of fusible plug, cartridge or linkage.

The T & P relief valve should have a maximum temperature rating of 100°C (210°F), a pressure rating NOT exceeding the lowest rated working pressure of any system component, and a discharge capacity exceeding the total input of the water boilers supplying water to the storage tank.

Locate the T & P relief valve (a) in the top of the storage tank or (b) in the side of the tank on centerline within upper 6 inches from the top of the tank. Refer to the Piping Diagrams section in Instruction Manual. Tapping shall be threaded in accordance with the latest version of the Standard for Pipe Threads, General Purpose (inch), ANSI/ASME B.120.1.

TANK TEMPERATURE CONTROL

The water temperature in the storage tank is controlled by the Tank Temperature Control. The sensing element is mounted inside the hot water storage tank.

⚠ DANGER

Water temperature over 125°F (52°C) can cause severe burns instantly resulting in severe injury or death.

Children, the elderly and the physically or mentally disabled are at highest risk for scald injury.

Feel water before bathing or showering.

Temperature limiting devices such as mixing valves must be installed when required by codes and to ensure safe temperatures at fixtures.

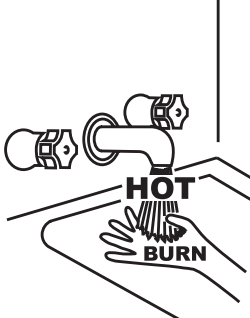

The tank temperature control is adjustable from 100°F (37.7°C) to 220°F (104.4°C). It is recommended that lower water temperatures be used to avoid the risk of scalding. It is further recommended, in all cases, that the water temperature be set for the lowest temperature which satisfies the user's hot water needs. This will also provide the most energy efficient operation of the boiler and minimize scale formation.

The boiler should be located in an area where the general public does not have access to set temperatures. Setting the water temperature at 120°F (49°C) will reduce the risk of scalds.

Some people are more likely to be permanently injured by hot water than others. These include the elderly, children, the infirm and the physically/mentally disabled. Table 1 shows the approximate time-to-burn relationship for normal adult skin. If anyone using hot water provided by the boiler being installed fits into one of these groups or if there is a local code or state law requiring a certain water temperature at the point of use, then special precautions must be taken. Contact a qualified service technician or qualified agency.

TABLE 1. TEMPERATURE AND TIME TO PRODUCE BURNS

Water Temperature	Time to Produce 2nd & 3rd Degree Burns on Adult Skin
180°F (82°C)	Nearly instantaneous
170°F (77°C)	Nearly instantaneous
160°F (71°C)	About 1/2 second
150°F (66°C)	About 1-1/2 seconds
140°F (60°C)	Less than 5 seconds
130°F (54°C)	About 30 seconds
120°F (49°C)	More than 5 minutes

Use anti-scald valve(s) in the hot water system to reduce the risks of scalds at points of use such as lavatories, sinks and bathing facilities.

A change in water temperature in the storage tank lower than the Tank Temperature Control setting will cause the sensor to close its contacts and consequently energize the boiler.

If the Tank Temperature Control is out of calibration, replace it with a new one; do not attempt to fix this control.

THERMOMETERS

Thermometers should be obtained and field installed as shown in the installation diagrams.

Thermometers are installed in the system as a means of detecting a possible liming condition in the boiler. An increase of 5°F (3°C) over the normal temperature rise through the boiler is an indication that lime is present. The term "temperature" designates the difference between the boiler inlet and outlet water temperature.

An increase of 5°F (3°C) above the recorded temperature rise may signify a liming condition in the coils or heat exchanger. Refer to Cleaning and Flushing Instructions on Page 24 for deliming instructions.

Record temperature rise at initial start-up for future reference.

DRAIN VALVE (NOT SUPPLIED)

A drain valve must be obtained and installed on each boiler and tank for draining purposes.

BOILER START UP AND OPERATIONS

After placing the boiler into operation, the ignition system safety shutoff device must be tested by the following test method.

1. Reset High Limit Temperature Control to lowest setting. (See Figure 2 on Page 7).
2. Reset System Controller to maximum setting, causing a call for heat and allowing unit to run until High Limit Temperature Control trips.
3. Resetting the High Limit Temperature Control to a higher setting, unit should run.
4. Reset System Controller and High Limit Temperature Control to desired temperature. If unit fails to run, refer to Troubleshooting section in this manual on Page 16.

Before operating the boiler, the entire system must be filled with water, purged of air and checked for leaks. Do not use Stop Leak or other boiler compounds. The gas piping should also be leak tested.

Any safety devices including low water cutoffs used in conjunction with this boiler should receive periodic (every six months) inspection to assure proper operation. A low water cutoff device of the float type should be flushed every six months. All pressure relief valves should be inspected and manually operated at least twice a year.

IMPORTANT

It is recommended that a qualified service technician perform the initial firing of the boiler. At this time the user should not hesitate to ask the individual any questions which he may have in regard to the operation and maintenance of the unit.

FILLING THE SYSTEM

1. Fast fill system through bypass until pressure approaches desired system pressure. Close bypass valve and permit pressure to be established by the pressure reducing valve.
2. Vent all high points in system to purge system of air.

If pressure bleeding of system is desired, install valves as shown in the Piping Diagrams of the Instruction Manual.

Where cast iron radiation and motorized valves are used, conventional system pressure and installation practices should be followed.

Provisions should be made to permit manual venting of radiators or convectors.

PRECAUTIONS

If the unit is exposed to the following, do not operate boiler until all corrective steps have been made by a qualified service technician:

- Flooding to level of burner or controls or higher.
- Exposure to fire.
- If damaged.
- Firing without water.
- Sooting.

CAUTION

Gas Supply

Should overheating occur or the gas supply fail to shut off, turn off the gas supply at a location external to the boiler (i.e., main manual gas shutoff valve).

PILOT AND MAIN BURNER

To maintain safe operation of the boiler, check the pilot and the main burner once every six months for proper flame characteristics.

1. MAIN BURNER

The main burner, Figure 6, should display the following characteristics:

- Provide complete combustion of gas.
- Cause rapid ignition and carryover of flame across entire burner.
- Give reasonably quiet operation during ignition, burning and extinction.
- Cause no excessive lifting of flame from burner ports.

If the proceeding burner characteristics are not evident, check for accumulation of lint or other foreign material that restricts or blocks the air openings to the burner or boiler.

Also check for good flow of combustion and ventilating air to the unit. Maintain a clear area around the boiler at all times.

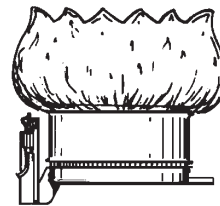

FIGURE 6. MAIN BURNER

The boiler should be periodically inspected by a qualified servicer for continuous safe operation.

Qualified servicers should follow this procedure when the boiler's burners need cleaning.

- a. Turn off the electrical power and close the main manual gas shutoff valve. Refer to Lighting & Operating Instructions on Pages 14 and 15.
 - Allow boiler parts to cool before disassembly.
- b. Remove main burner manifold assembly from boiler.
 - Refer to parts list supplied with this manual for disassembly aid.
- c. Remove any loose foreign material such as dust or lint with a vacuum. Check all ports, orifices, and air openings for blockage. Dislodge any foreign material causing blockage. Remove any soot or carbon deposits with a rag making sure to remove any lint left on burner by vacuuming again.
- d. Reinstall the burner manifold assembly on boiler.
- e. Restore electrical power and gas supply to boiler.
 - Put the boiler back in operation by following the lighting instructions in this manual or on the lighting and operating label on the boiler. Refer to Pages 14 and 15.
 - Check for gas leaks and proper boiler and vent operation.

2. PILOT BURNER - ELECTRONIC IGNITION

To establish pilot flame without main burner operation, it will be necessary to perform the following steps:

Servicing of the pilot burner (every six months) includes keeping pilot shield (not shown) free of lint, cleaning the burner head, the primary air opening and the orifice of the pilot burner, Figure 7.

- Open fused disconnect switch or shut off electrical power to the boiler.
- Disconnect wire from MV wire on valve.
- Close fused disconnect switch to restore electrical power to the boiler.

The pilot will now ignite provided the system is calling for heat.

- Adjust pilot flame.

To adjust the pilot flame, remove the cap screw from the pilot adjusting screw (Figure 8) and turn to deliver a sufficient flame at the pilot burner to cover $3/8"$ to $1/2"$ (10-12 mm) of the sensing probe tip. See Figure 7.

Check for good terminal connection at the sensing probe at the pilot burner assembly if pilot does not light.

Check for electrical power to the valve. If electrical power and gas are present at the valve and the pilot does not operate when system calls for heat, replace valve.

- Low gas pressure
 - Adjust pilot flame by means of the pilot gas adjustment located in the gas control valve.
 - The pilot flame should envelop $3/8"$ to $1/2"$ (10-12 mm) of the tip of the thermocouple. Remove pilot adjustment cover screw, Figure 8. Turn inner adjustment screw or pilot adjusting valve clockwise to decrease, or counterclockwise to increase pilot flame. Be sure to replace cover screw on combination gas control valve after adjustment to prevent possible gas leakage.
- Clogged pilot burner orifice.
 - Clean or replace orifice. A clogged orifice will restrict gas flow and result in low thermocouple output.
- Incorrect orifice.
 - Replace. The Orifice size is stamped on the wrench flats.
- Clogged primary air opening.
 - Restricted air passages will soften the pilot flame and result in poor thermocouple flame impingement.

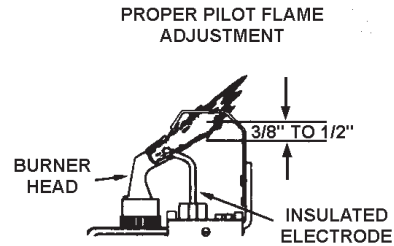
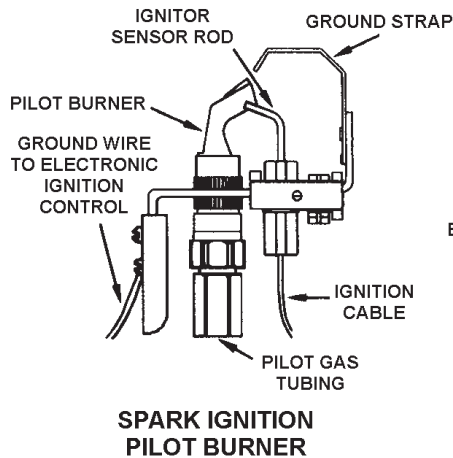

FIGURE 7. SPARK IGNITION PILOT BURNER AND BURNER FLAME

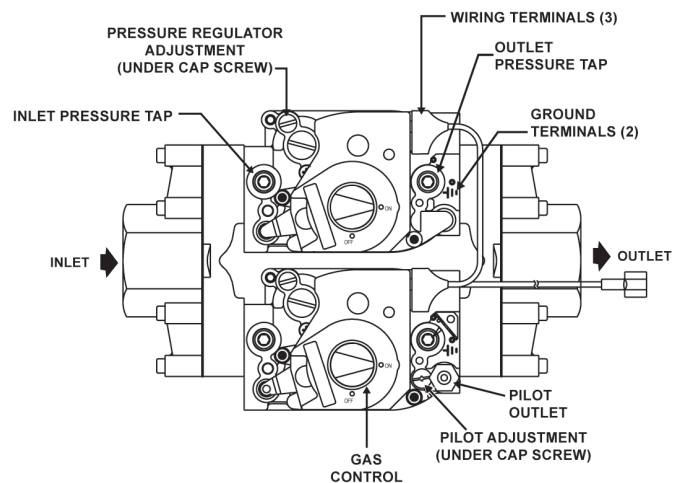
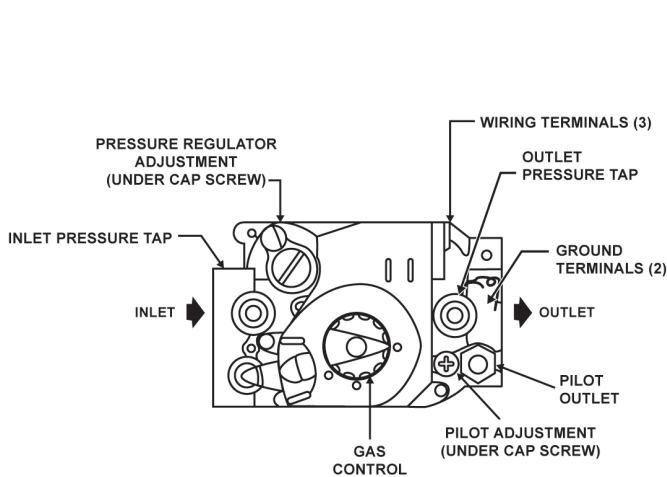

FIGURE 8. ADJUSTING PILOT FLAME

CHECKING AND ADJUSTING INPUT

! WARNING

Fire and Explosion Hazard

- Under no circumstances should the input exceed the rate shown on the boiler's rating label.
- Overfiring could result in fire or explosion.
- Gas and carbon monoxide detectors are available.

! WARNING

Breathing Hazard - Carbon Monoxide Gas

- Under no circumstances should the input exceed the rate shown on the boiler's rating label.
- Overfiring could result in damage to the boiler's and sooting.
- Gas and carbon monoxide detectors are available.

Breathing carbon monoxide can cause brain damage or death. Always read and understand instruction manual.

5. Repeat steps 1 thru 6 of the OPERATING INSTRUCTIONS.
6. Remove the pressure gauge or manometer from the manifold pressure tapping. Replace the screw-in plug in the manifold pressure tap.
7. Repeat steps 7 thru 11 of the OPERATING INSTRUCTIONS on Page 15. The boiler will resume normal operation.

When the boiler is operating at full capacity, or full gas input, it should consume 1 cu.ft. of gas in approximately the time indicated in Table 2.

TABLE 2. CONSUMPTION RATE (REFER TO OPERATING AT FULL INPUT OR FULL CAPACITY)

TYPE GAS	HEATING VALUE BTU/FT.	TIME TO CONSUME 1 CU. FT. OF GAS (SECONDS)				
		HW-300	HW-399	HW-420	HW-520	HW-670
Natural	1050	12.6	9.5	9.0	7.3	5.7
Propane	2500	30.0	22.6	21.4	17.3	13.4

Minor variances from input on rating plate can be corrected by adjustment of gas pressure regulators.

The inlet gas pressure must not exceed or be less than the values shown on rating plate.

1. Follow steps 1 thru 6 of the OPERATING INSTRUCTIONS on Page 15.
2. Attach a pressure gauge or a manometer to the manifold pressure tapping and refer to Table 2 for correct manifold pressure.
3. Follow steps 7 thru 11 of the OPERATING INSTRUCTIONS.
4. Use this formula to "clock" the meter. Be sure that other gas consuming appliances are not ON during this interval.

$$\frac{3600}{T} \times H = \text{Btuh}$$

Btuh = The approximate actual input rate.
 T = Time in seconds to burn one cubic foot of gas.
 H = Heating value of the fuel gas in Btu per cubic foot of gas.

EXAMPLE:

T = 9.0 seconds/ft³
 H = 1050 Btu/ft³(natural gas)
 Btuh = ?

Gas flow through meter:

$$\frac{3600}{9.0} \times 1050 = 420,000 \text{ Btuh}$$

Small changes in the input rate may be made by adjusting the manifold pressure, refer to Gas Manifold Pressure Regulators in the Instruction Manual. Under no circumstances should you exceed the maximum input rate for the boiler. Refer to Recovery Capacities Table in the Instruction Manual.

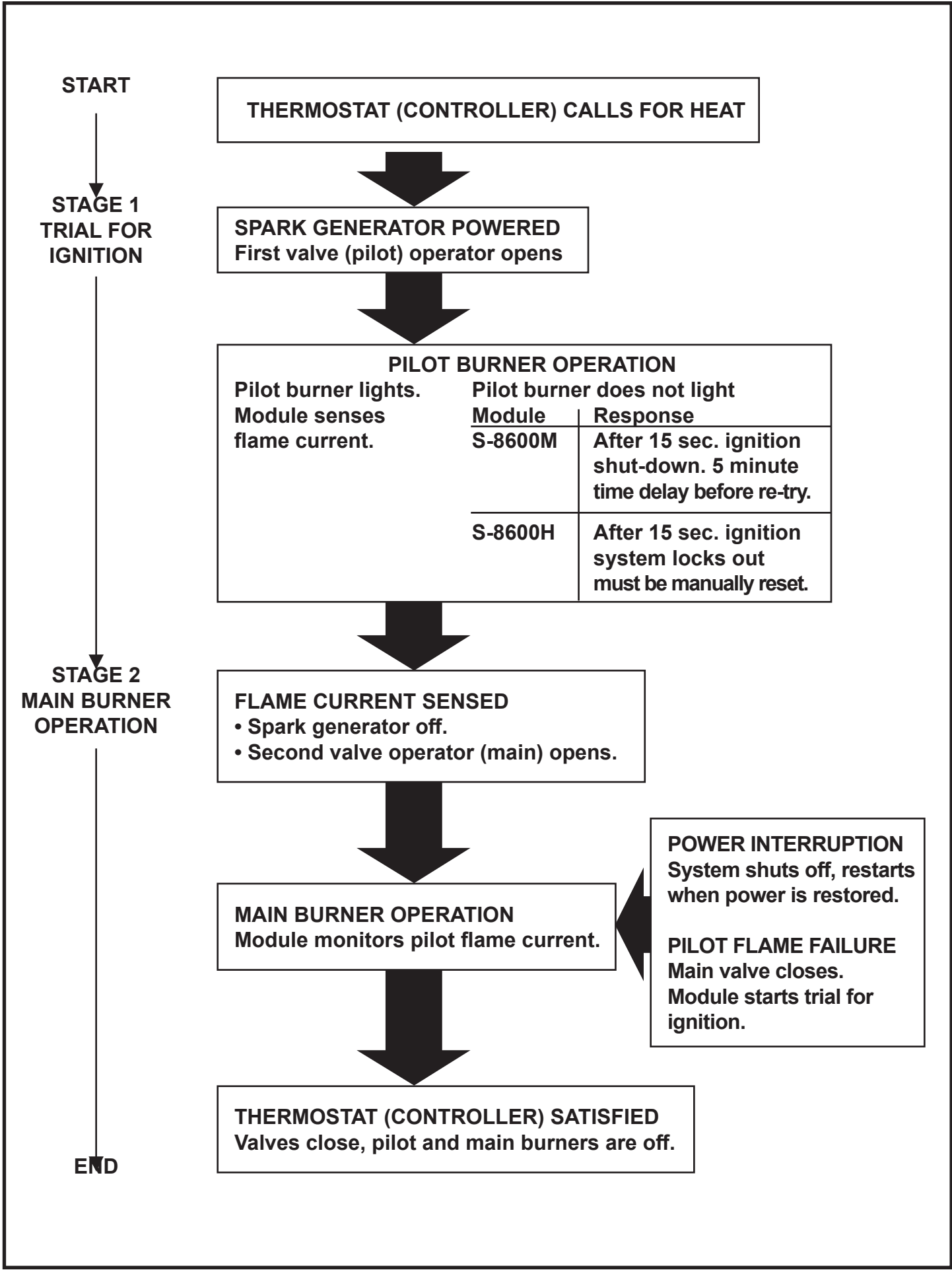

FOR YOUR SAFETY READ BEFORE LIGHTING



WARNING: If you do not follow these instructions exactly, a fire or explosion may result causing property damage, personal injury or loss of life.



WARNING: HOT WATER CAN PRODUCE 3rd DEGREE BURNS IN 6 SECONDS AT 140° F. (60° C).

IN CASE OF POWER FAILURE DO NOT ATTEMPT TO OPERATE APPLIANCE. IMPROPER INSTALLATION, ADJUSTMENT, ALTERATION, SERVICE OR MAINTENANCE CAN CAUSE PROPERTY DAMAGE, PERSONAL INJURY OR LOSS OF LIFE. REFER TO THE USER'S INFORMATION MANUAL PROVIDED WITH THIS APPLIANCE. INSTALLATION AND SERVICE MUST BE PERFORMED BY A QUALIFIED INSTALLER, SERVICE AGENCY OR THE GAS SUPPLIER.

- A. THIS APPLIANCE IS EQUIPPED WITH AN IGNITION DEVICE WHICH AUTOMATICALLY LIGHTS THE PILOT. DO NOT TRY TO LIGHT THE PILOT BY HAND.
- B. BEFORE OPERATING: SMELL ALL AROUND THE APPLIANCE AREA FOR GAS. BE SURE TO SMELL NEXT TO THE FLOOR BECAUSE SOME GAS IS HEAVIER THAN AIR AND WILL SETTLE ON THE FLOOR.

WHAT TO DO IF YOU SMELL GAS

- DO NOT TRY TO LIGHT ANY APPLIANCE.
 - DO NOT TOUCH ANY ELECTRIC SWITCH; DO NOT USE ANY PHONE IN YOUR BUILDING
 - IMMEDIATELY CALL YOUR GAS SUPPLIER FROM A NEIGHBOR'S PHONE. FOLLOW THE GAS SUPPLIER'S INSTRUCTIONS.
 - IF YOU CANNOT REACH YOUR GAS SUPPLIER, CALL THE FIRE DEPARTMENT.
- C. USE ONLY YOUR HAND TO TURN THE GAS CONTROL KNOB. NEVER USE TOOLS. IF THE KNOB WILL NOT TURN BY HAND, DO NOT TRY TO REPAIR IT. CALL A QUALIFIED SERVICE TECHNICIAN. FORCE OR ATTEMPTED REPAIR MAY RESULT IN A FIRE OR EXPLOSION.
 - D. DO NOT USE THIS APPLIANCE IF ANY PART HAS BEEN UNDER WATER. IMMEDIATELY CALL A QUALIFIED SERVICE TECHNICIAN TO INSPECT THE APPLIANCE AND TO REPLACE ANY PART OF THE CONTROL SYSTEM AND ANY GAS CONTROL WHICH HAS BEEN UNDER WATER.

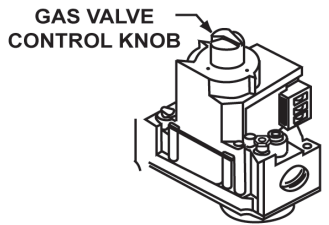

HONEYWELL GAS VALVE

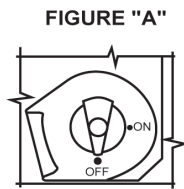

"OFF" POSITION

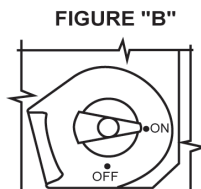

"ON" POSITION

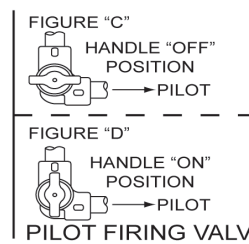

PILOT FIRING VALVE

LIGHTING INSTRUCTIONS

1. STOP! READ THE SAFETY INFORMATION ABOVE ON THIS LABEL.
2. MAKE SURE BOILER AND SYSTEM ARE FILLED WITH WATER AND ALL AIR HAS BEEN EXPELLED FROM APPLIANCE.
3. TURN OFF ALL ELECTRIC POWER TO THE APPLIANCE. SET SYSTEM TEMPERATURE CONTROLLER TO LOWEST SETTING. PURGE ALL GAS LINES OF AIR.
4. DO NOT ATTEMPT TO LIGHT THE PILOT BY HAND
5. REFER TO DIAGRAMS ABOVE. TURN TOP KNOB OF GAS CONTROL CLOCKWISE ↻, TO "OFF" POSITION (FIG. A)
6. WAIT FIVE (5) MINUTES TO CLEAR OUT ANY GAS. THEN SMELL FOR GAS, INCLUDING NEAR THE FLOOR. IF YOU SMELL GAS, STOP! FOLLOW "B" IN THE SAFETY INFORMATION ABOVE ON THIS LABEL. IF YOU DON'T SMELL GAS, GO TO THE NEXT STEP.
7. TURN TOP KNOB OF GAS CONTROL COUNTER-CLOCKWISE ↺ TO "ON" (FIG. B). OPEN FIRING AND PILOT MANUAL VALVES, COUNTER-CLOCKWISE ↺.
8. TURN ON ALL ELECTRIC POWER TO THE APPLIANCE.
9. SET SYSTEM TEMPERATURE CONTROLLER TO DESIRED SETTING.
10. WHEN CONTROLLER CALLS FOR HEAT, THE CIRCULATING PUMP WILL OPERATE AND THE PILOT BURNER WILL BE SPARK IGNITED. GAS CONTROL WILL OPEN AND MAIN BURNER WILL THEN IGNITE. NOTE: IF PILOT FAILS TO IGNITE, TURN OFF APPLIANCE AND CONSULT YOUR "INSTALLATION AND USER'S MANUAL" FOR ADJUSTMENTS AND TROUBLE SHOOTING.
11. IF THE APPLIANCE WILL NOT OPERATE, FOLLOW THE INSTRUCTIONS "TO TURN OFF GAS TO APPLIANCE" AND CALL YOUR SERVICE TECHNICIAN OR GAS SUPPLIER.

TO TURN OFF GAS TO APPLIANCE

- A. SET THE SYSTEM CONTROLLER TO THE LOWEST SETTING.
- B. TURN OFF ELECTRICAL POWER TO APPLIANCE.
- C. TURN TOP KNOB OF GAS CONTROL VALVE CLOCKWISE ↻ TO "OFF" POSITION SEE, (FIG. A). CLOSE FIRING AND PILOT MANUAL VALVES, CLOCKWISE ↻. SEE ABOVE.

FOR YOUR SAFETY READ BEFORE LIGHTING



WARNING: If you do not follow these instructions exactly, a fire or explosion may result causing property damage, personal injury or loss of life.



- A. THIS APPLIANCE IS EQUIPPED WITH AN IGNITION DEVICE WHICH AUTOMATICALLY LIGHTS THE PILOT. DO NOT TRY TO LIGHT THE PILOT BY HAND.
- B. BEFORE LIGHTING: SMELL ALL AROUND THE APPLIANCE AREA FOR GAS. BE SURE TO SMELL NEXT TO THE FLOOR BECAUSE SOME GAS IS HEAVIER THAN AIR AND WILL SETTLE ON THE FLOOR.
- WHAT TO DO IF YOU SMELL GAS
- DO NOT TRY TO LIGHT ANY APPLIANCE.
 - DO NOT TOUCH ANY ELECTRIC SWITCH.
 - DO NOT USE ANY PHONE IN YOUR BUILDING.
 - IMMEDIATELY CALL YOUR GAS SUPPLIER FROM A NEIGHBOR'S PHONE. FOLLOW THE GAS SUPPLIER'S INSTRUCTIONS.
 - IF YOU CANNOT REACH YOUR GAS SUPPLIER, CALL THE FIRE DEPARTMENT.
- C. USE ONLY YOUR HAND TO TURN THE GAS CONTROL KNOB. NEVER USE TOOLS. IF THE KNOB WILL NOT TURN BY HAND, DON'T TRY TO REPAIR IT. CALL A QUALIFIED SERVICE TECHNICIAN. FORCE OR ATTEMPTED REPAIR MAY RESULT IN A FIRE OR EXPLOSION.
- D. DO NOT USE THIS APPLIANCE IF ANY PART HAS BEEN UNDER WATER. IMMEDIATELY CALL A QUALIFIED SERVICE TECHNICIAN TO INSPECT THE APPLIANCE AND TO REPLACE ANY PART OF THE CONTROL SYSTEM AND ANY GAS CONTROL WHICH HAS BEEN UNDER WATER.
- E. DO NOT OPERATE APPLIANCE UNLESS UNIT IS FILLED WITH WATER AND INLET LINES ARE FULLY OPEN.

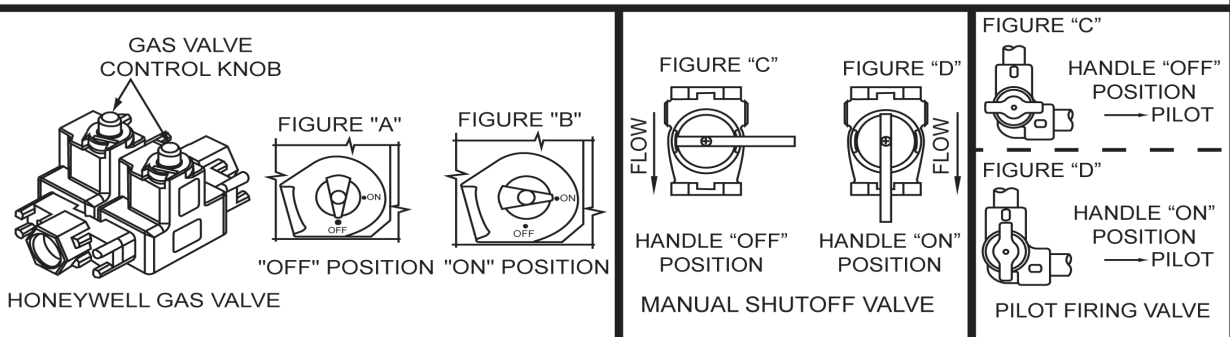

OPERATING INSTRUCTIONS

- STOP! READ THE SAFETY INFORMATION ABOVE ON THIS LABEL.
 - SET THE THERMOSTAT TO LOWEST SETTING.
 - TURN OFF ALL ELECTRIC POWER TO THE APPLIANCE.
 - THIS APPLIANCE IS EQUIPPED WITH AN IGNITION DEVICE WHICH AUTOMATICALLY LIGHTS THE PILOT. DO NOT TRY TO LIGHT THE PILOT BY HAND.
 - REFER TO DIAGRAMS ABOVE. TURN TOP KNOB OF GAS CONTROL CLOCKWISE ↻, TO "OFF" POSITION (FIG. A)
 - TURN MANUAL SHUTOFF VALVE COUNTERCLOCKWISE ↻ TO "OFF" (FIG C). TURN PILOT MANUAL VALVE COUNTERCLOCKWISE ↻ TO "OFF" (FIG E).
 - WAIT FIVE (5) MINUTES TO CLEAR OUT ANY GAS. THEN SMELL FOR GAS, INCLUDING NEAR THE FLOOR. IF YOU SMELL GAS, STOP! FOLLOW "B" IN THE SAFETY INFORMATION ABOVE ON THIS LABEL. IF YOU DON'T SMELL GAS, GO TO THE NEXT STEP
 - TURN TOP KNOB OF GAS CONTROL COUNTERCLOCKWISE ↻ TO "ON" (FIG B).
 - TURN PILOT FIRING VALVE CLOCKWISE ↻ TO "ON" (FIG F).
 - TURN ON ALL ELECTRIC POWER TO THE APPLIANCE.
 - SET THERMOSTAT TO DESIRED SETTING. PILOT BURNER WILL BE IGNITED BY ELECTRONIC SPARK.
 - LOCATE PEEP HOLE IN FRONT OF THE PILOT BURNER. MAKE SURE PILOT IS BURNING.
- ADVISORY: THERE IS A FIFTEEN (15) SECOND TRIAL PERIOD FOR PILOT IGNITION WHICH IS TIME ENOUGH FOR IGNITION WHEN AIR HAS BEEN BLED FROM GAS LINES PRIOR TO IGNITION ATTEMPT. IF PILOT FAILS TO IGNITE AND YOU SUSPECT THAT IT IS DUE TO AIR IN THE LINES, CLOSE PILOT MANUAL VALVE AND REPEAT LIGHTING PROCEDURE STEPS 1 THRU 12
- WITH PILOT FLAME ESTABLISHED, TURN MANUAL SHUT OFF VALVE CLOCKWISE ↻ TO "ON" (FIG D), TO ALLOW GAS TO REACH MAIN BURNER. NOTE: THE REDUNDANT MAIN COMBINATION VALVE WILL ALREADY BE OPEN, AND MAIN BURNER WILL IGNITE.
- ADVISORY: IF MAIN BURNER FAILS TO IGNITE, MAKE SURE PILOT IS BURNING. IF THE APPLIANCE WILL NOT OPERATE, FOLLOW THE INSTRUCTIONS BELOW ON THIS LABEL "TO TURN OFF GAS TO APPLIANCE" AND CALL YOUR SERVICE TECHNICIAN OR GAS SUPPLIER.

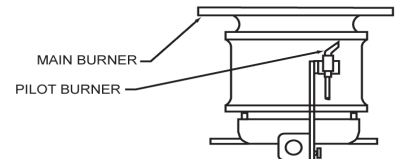

TO TURN OFF GAS TO APPLIANCE

- TURN OFF ALL ELECTRICAL POWER TO APPLIANCE.
- TURN TOP KNOB OF GAS CONTROL VALVE CLOCKWISE ↻ TO "OFF". (FIG. "A")
- TURN MAIN FIRING VALVE COUNTERCLOCKWISE ↻ TO "OFF" (FIG. "C"), AND TURN PILOT FIRING VALVE COUNTERCLOCKWISE ↻ TO "OFF" (FIG "E").
- SET THE THERMOSTAT TO LOWEST SETTING.

TROUBLESHOOTING

Before any extensive troubleshooting, perform the following:

Ensure that:

- Voltage (120 vac) is supplied to the boiler.
- System control (tank temperature control, thermostat, etc.) is calling for boiler operation (call for heat).
- Other contacts (switches) are closed (relay, low water cutoff, flow switch, coil protector, pressure switch, etc.).
- Gas supply pressure is within the maximum and minimum operating ranges listed on the boiler rating plate/label.

- Voltage (24 vac) is supplied by transformer.
- Boiler is wired according to wiring diagram.

Note: Cross wiring the 24 volt circuit of the relay will short the transformer.

- All wire terminals/connectors are firmly attached to valves, modules, switches, limit controls, etc.
- For Propane (LP) models only check for possible lockout condition of the ignition module.

TABLE 3. CER-TEMP 80 RECOVERY SYSTEM CHECKOUT PROCEDURE

Use this checkout for Cer-Temp 80 Recovery Systems. (For hot water supply application only)

CHECKOUT SEQUENCE	SYSTEM OPERATION		CAUSE	REMEDY
	CORRECT	INCORRECT		
Set tank temperature control (thermostat) 20°F (10°C) below tank water temperature.	Circulating pump and burner shut off.	Pump and burner remain on.	Tank temperature control (thermostat) defective.	Replace.
			System wiring is incorrect.	Correct wiring.
	With thermal balancer, pump off delay of approximately 2 minutes.	Circulating pump on.	Pump wired for continuous operation.	Correct wiring.
			Burner on.	Gas control valve stuck or defective.
		System wiring is incorrect.		Correct wiring.
Set tank temperature control (thermostat) 20°F (10°C) above tank water temperature.	Circulating pump and burner on.	Circulating pump on.	High limit control set too low.	Replace. (If problem proven to be at this control by applying jumper to terminals.)
			High limit control differential too wide.	
			System wiring is incorrect.	Correct wiring.
			Coil protector switch has activated.	Remove control cover, depress reset button.
			Gas control valve or wiring defective.	Check wiring. Repair or replace valve.
	Circulating pump and burner off.	Circulating pump and burner off.	Power off or system wiring is incorrect.	Check power supply and wiring.
			Tank temperature control (thermostat) defective.	Replace.
		Burner on.	System wiring is incorrect.	Correct wiring.
Boiler outlet temperature exceeds 210°F (100°C).	Circulating pump on.	Circulating pump and burner on.	High limit control defective, or set too high (max. should be set at 200°F).	Replace.
Set tank temperature control (thermostat) for desired water temperature.	System maintains desired water temperature.			

CHECKING HONEYWELL S-8600H OR S-8600M INTERMITTENT IGNITION CONTROLS

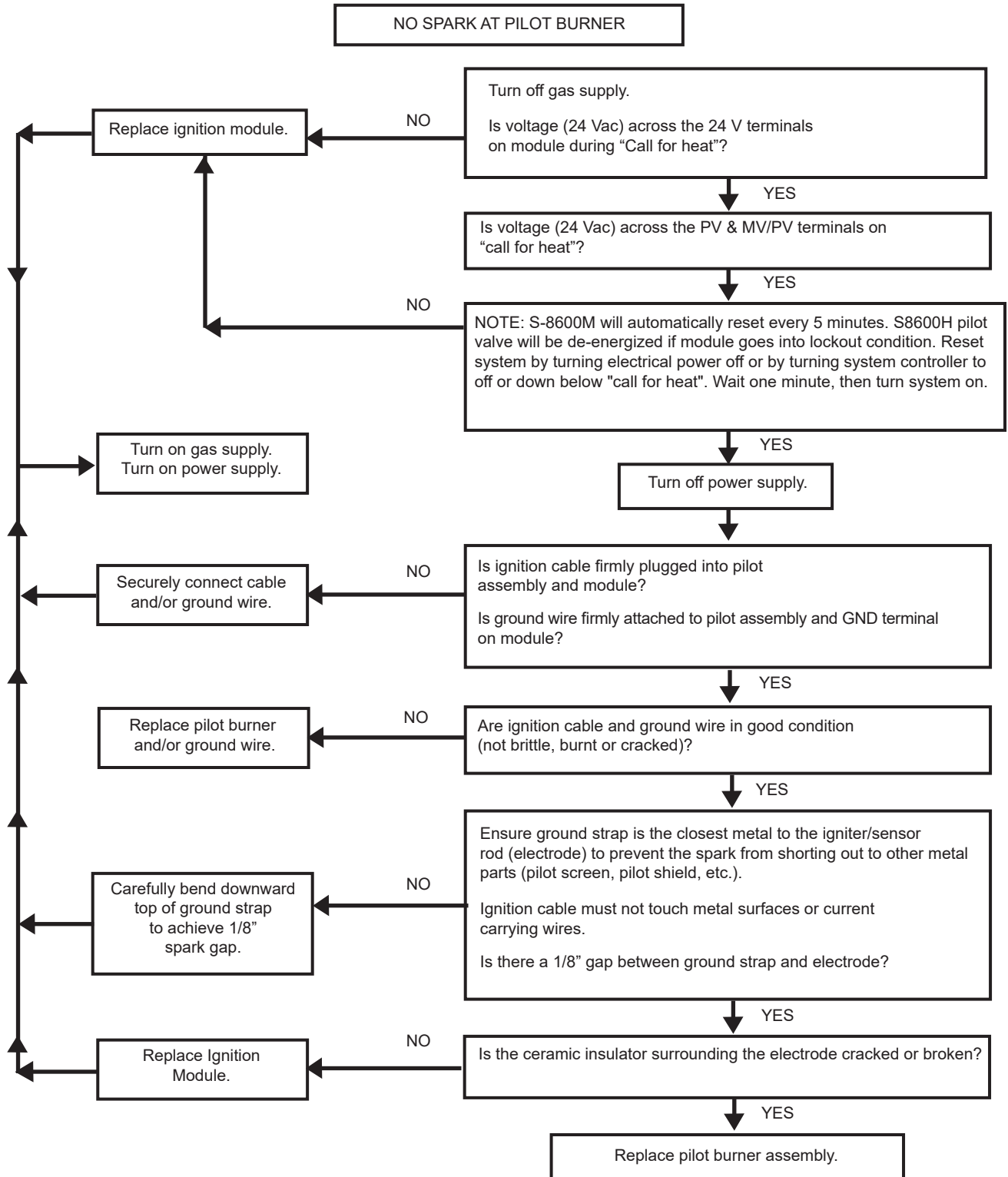

CHECKING HONEYWELL S-8600H OR S-8600M INTERMITTENT IGNITION CONTROLS

SPARK AT PILOT BURNER BUT PILOT WILL NOT LIGHT

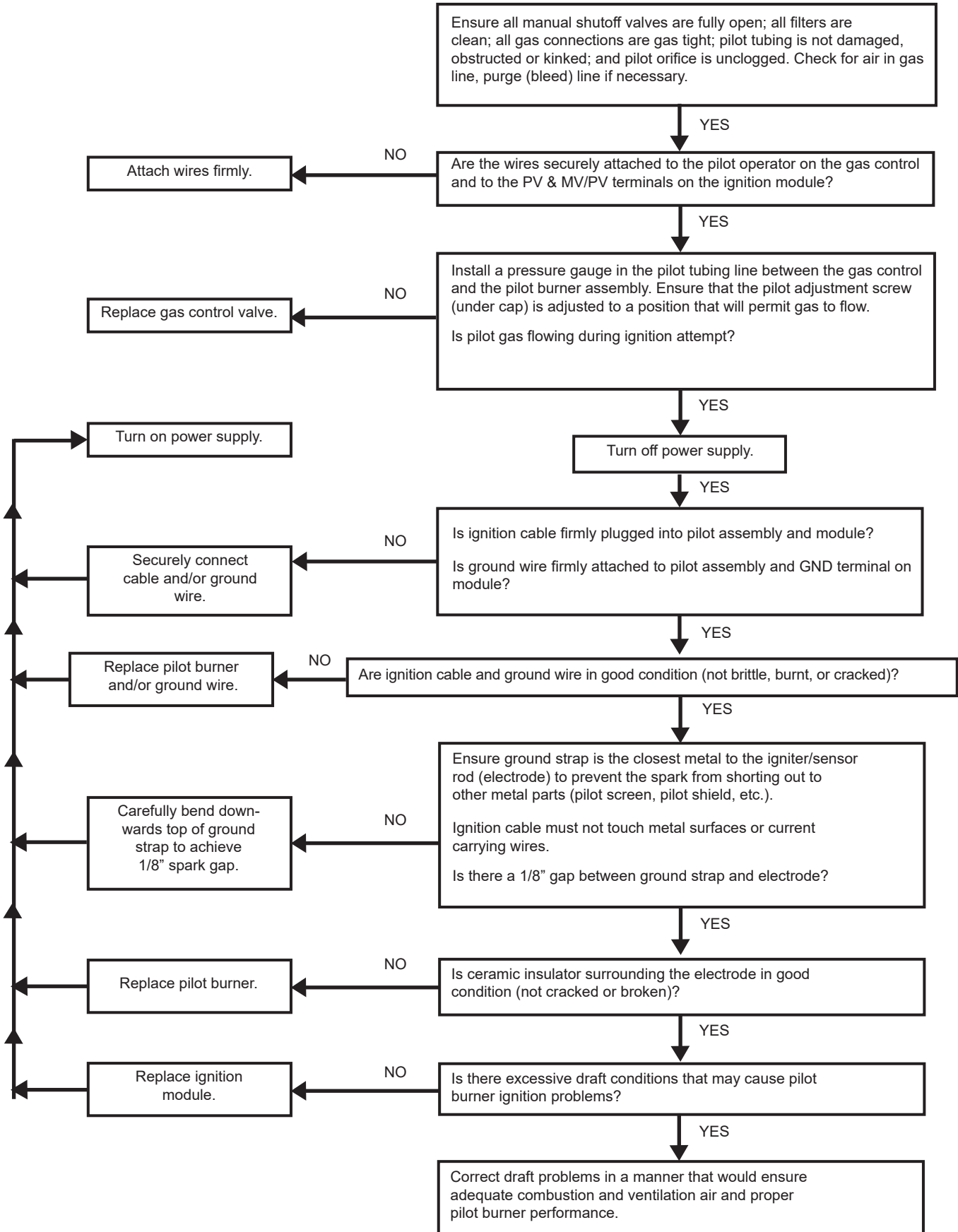

**CHECKING HONEYWELL S-8600H OR S-8600M
INTERMITTENT IGNITION CONTROLS**

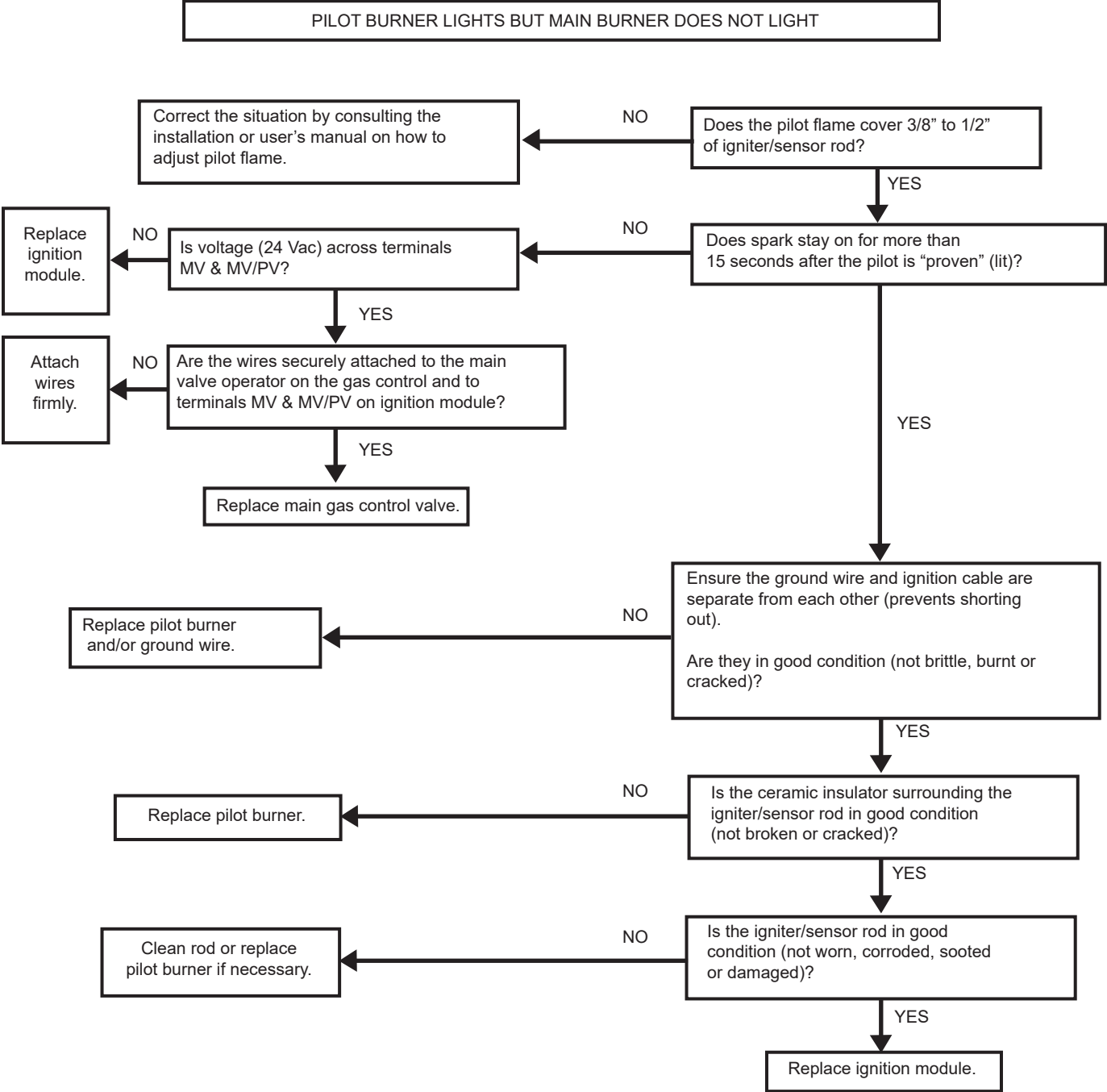

CHECKING HONEYWELL S8600H OR S-8600M INTERMITTENT IGNITION CONTROLS

NO SPARK AT PILOT BURNER BUT PILOT WILL NOT LIGHT

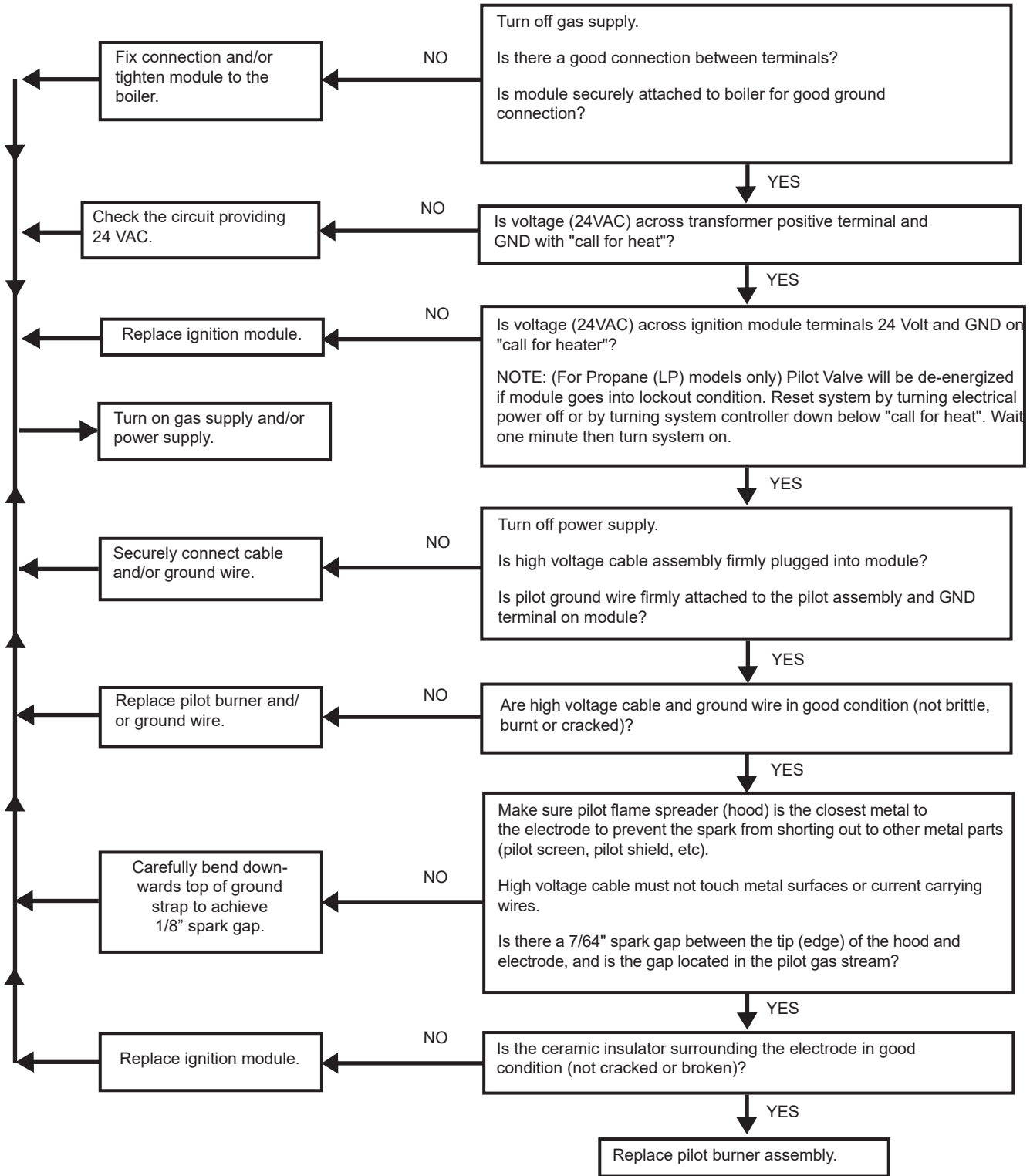

The following procedures are provided as a general guide.

Any module should be replaced if it does not perform properly on checkout or troubleshooting.

In addition, replace any module if it is wet or looks like it has ever been wet.

LED STATUS AND TROUBLESHOOTING

The control has two LEDs; one for flame sensing and one for system status:

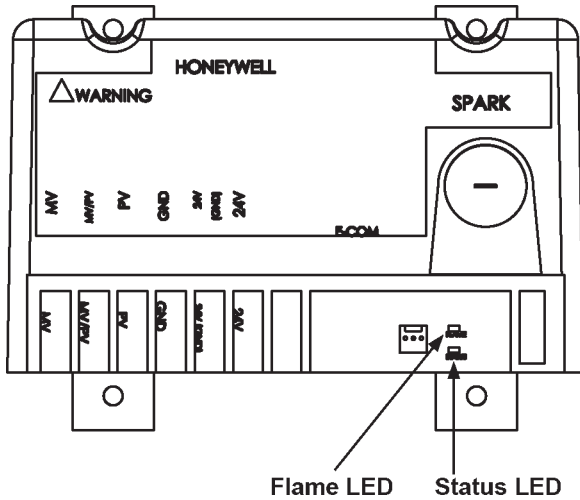

FIGURE 9. LOCATION OF LED'S

- Flame LED (Yellow)
Indicates flame presence and strength. Refer to Table 4.
- Status LED (Green)
Indicates system operation status and error conditions. Refer to Table 5 and Table 6 on Pages 22 and 23 for status specific to each model.

TABLE 4. YELLOW LED FLAME CODES

YELLOW LED FLASH CODE ^A	INDICATES	RECOMMENDED SERVICE ACTION
Heartbeat	Normal Flame Signal	not applicable
2	Weak Flame Signal- System will operate reliably but flame signal is less than desired. NOTE: This indication may flash temporarily during or shortly after lightoff on some applications.	Perform routine maintenance to assure optimum flame signal.
1	Marginal Flame Signal (less than 1.1 μ A)- System may not operate reliably over time. Service call recommended. NOTE: This indication may flash temporarily during or shortly after lightoff on some applications.	Check gas supply, pilot burner, flame sense wiring, contamination of flame sensor, burner ground connection.
OFF	No Flame or Flame Signal below minimum threshold for system operation.	not applicable

^AFlash Code Descriptions:

- Heartbeat: Constant 1/2 second bright 1/2 second dim cycles.
- The flash code number signifies that the LED flashes X times at 2Hz, remains off for two seconds, and then repeats the sequence.

TABLE 5. CONTINUOUS RETRY MODELS C, M, E AND K ONLY - GREEN LED STATUS CODES

GREEN LED FLASH CODE (X+Y) ^A	INDICATES	NEXT SYSTEM ACTION	RECOMMENDED SERVICE ACTION
OFF	No "Call for Heat"	not applicable	none
Flash Fast	Startup - Flame sense calibration	not applicable	none
Heartbeat	Normal operation	not applicable	none
2	5 minute Retry Delay • Pilot flame not detected during trial for ignition	Initiate new trial for ignition after retry delay completed.	If system fails to light on next trial for ignition check gas supply, pilot burner, spark and flame sense wiring, flame sensor contaminated or out of position, burner ground connection.
3	Recycle • Flame failed during run	Initiate new trial for ignition. Flash code will remain through the ignition trial until flame is proved.	If system fails to light on next trial for ignition, check gas supply, pilot burner, flame sense wiring, contamination of flame sensor, burner ground connection.
4	Flame sensed out of sequence	If situation self corrects within 10 seconds, control returns to normal sequence. If flame out of sequence remains longer than 10 seconds, control goes to Flash code 6+4 (see below).	Check for pilot flame. Replace gas control valve if pilot flame is present. If no pilot flame, cycle "Call for Heat." If error repeats, replace control.
7	Flame sense leakage to ground	Control remains in wait mode. When the fault corrects, control resumes normal operation after a one minute delay.	Check flame sense lead wire for damage or shorting. Check that flame sensor is in proper position. Check flame sensor ceramic for cracks, damage or tracking.
8	Low secondary voltage supply- (below 15.5 Vac)	Control remains in wait mode. When the fault corrects, control resumes normal operation after a one minute delay.	Check transformer and AC line for proper input voltage to the control. Check with full system load on the transformer.
6+2	5 minute Retry Delay • On every third retry on the same "Call for Heat"	Initiate new trial for ignition after retry delay completed.	Check gas supply line, pilot burner, spark and flame sense wiring, flame sensor contaminated or out of position, burner ground connection.
6+3	On every 6th flame failure during run on the same "Call for Heat"	5 minute retry delay, then initiate new trial for ignition.	Check gas supply, pilot burner, flame sense wiring, contamination of flame sensor, burner ground connection.
6+4	Flame sensed out of sequence- longer than 10 seconds	Control waits until flame is no longer sensed and then goes to soft lockout. Flash code continues. Control auto resets from soft lockout after one hour.	Check for pilot flame. Replace gas control valve if pilot flame present. If no pilot flame, cycle "Call for Heat." If error repeats, replace control.
ON	Soft lockout due to error detected during self check sequences	Control auto resets from soft lockout after one hour.	Reset by cycling "Call for Heat." If error repeats, replace the control.

^AFlash Code Descriptions:

- Flash Fast: rapid blinking.
- Heartbeat: Constant 1/2 second bright 1/2 second dim cycles.
- A single flash code number signifies that the LED flashes X times at 2Hz, remains off for two seconds, and then repeats the sequence.
- X+Y flash codes signify that the LED flashes X times at 2Hz, remains off for two seconds, flashes Y times at 2Hz, remains off for three seconds, and then repeats the sequence.

TABLE 6. LOCKOUT MODELS B, H, D AND J ONLY - GREEN LED STATUS CODES

GREEN LED FLASH CODE (X+Y) ^A	INDICATES	NEXT SYSTEM ACTION	RECOMMENDED SERVICE ACTION
OFF	No "Call for Heat"	not applicable	none
Flash Fast	Startup - Flame sense calibration	not applicable	none
Heartbeat	Normal operation	not applicable	none
3	Recycle • Flame failed during run	Initiate new trial for ignition. Flash code will remain through the ignition trial until flame is proved.	If system fails to light on next trial for ignition, check gas supply, pilot burner, flame sense wiring, contamination of flame sensor, burner ground connection.
4	Flame sensed out of sequence	If situation self corrects within 10 seconds, control returns to normal sequence. If flame out of sequence remains longer than 10 seconds, control goes to Flash code 6+4 (see below).	Check for pilot flame. Replace gas control valve if pilot flame is present. If no pilot flame, cycle "Call for Heat." If error repeats, replace control.
7	Flame sense leakage to ground	Control remains in wait mode. When the fault corrects, control resumes normal operation after a one minute delay.	Check flame sense lead wire for damage or shorting. Check that flame sensor is in proper position. Check flame sensor ceramic for cracks, damage or tracking.
8	Low secondary voltage supply- (below 15.5 Vac)	Control remains in wait mode. When the fault corrects, control resumes normal operation after a one minute delay.	Check transformer and AC line for proper input voltage to the control. Check with full system load on the transformer.
6+2	Failed trial for ignition resulting in lockout	Remain in lockout until "Call for Heat" is cycled.	Check gas supply line, pilot burner, spark and flame sense wiring, flame sensor contaminated or out of position, burner ground connection.
6+3	More than 5 flame failures during run on the same "Call for Heat" resulting in lockout	Remain in lockout until "Call for Heat" is cycled.	Check gas supply, pilot burner, flame sense wiring, contamination of flame sensor, burner ground connection.
6+4	Flame sensed out of sequence- longer than 10 seconds	Control waits until flame is no longer sensed and then goes to soft lockout. Flash code continues. Control auto resets from soft lockout after one hour.	Check for pilot flame. Replace gas control valve if pilot flame present. If no pilot flame, cycle "Call for Heat." If error repeats, replace control.
ON	Soft lockout due to error detected during self check sequences	Control auto resets from soft lockout after one hour.	Reset by cycling "Call for Heat." If error repeats, replace the control.

^AFlash Code Descriptions:

- Flash Fast: rapid blinking.
- Heartbeat: Constant 1/2 second bright 1/2 second dim cycles.
- A single flash code number signifies that the LED flashes X times at 2Hz, remains off for two seconds, and then repeats the sequence.
- X+Y flash codes signify that the LED flashes X times at 2Hz, remains off for two seconds, flashes Y times at 2Hz, remains off for three seconds, and then repeats the sequence.

MAINTENANCE PROCEDURES

These boilers are designed to give many years of efficient and satisfactory service when properly operated and maintained. To assure continued good performance, the following recommendations are made.

The area around the boiler should be kept clean and free from lint and debris. Sweeping the floor around the boiler should be done carefully. This will reduce the dust and dirt which may enter the burner and pilot air passages, causing improper combustion and sooting.

The flow of combustion and ventilation air to the boiler must not be obstructed. The boiler area must be kept clear and free from combustible materials, gasoline, and other flammable vapors and liquids.

Any safety devices including low water cutoffs used in conjunction with this boiler should receive periodic (every six months) inspection to assure proper operation. A low water cutoff device of the float type should be flushed every six months. All pressure relief valves should be inspected and manually operated at least twice a year. More frequent inspections may be necessary depending on water conditions.

Periodic checks, at least twice a year, should be made for water and/or gas leaks.

The boiler mounted gas and electrical controls have been designed to give both dependable service and long life. However, malfunction can occur, as with any piece of equipment. It is therefore recommended that all components be checked periodically by a qualified service technician for proper operation.

MANUAL RESET HIGH LIMIT SWITCH CONTINUITY TEST

Do not depress the switch reset button prior to testing. With the boiler being cold, disconnect the leads from the switch. With a multimeter place a probe on each side of the switch. If the meter reads zero the switch is good. If you receive an infinite or OL signal, the reason could be:

1. Switch contacts open.
 - Depress reset button on switch (switch cannot be reset until water temperature in the boiler coils drop below 200°F). Meter should read zero.
2. Defective switch or bad leads.
 - With leads attached, depress the switch button. If the meter does not read zero, the switch is defective and must be replaced.

PRESSURE RELIEF VALVE TEST

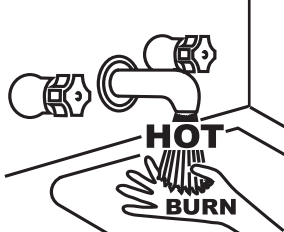
	<ul style="list-style-type: none">• Burn hazard.• Hot water discharge.• Keep clear of Pressure Relief Valve discharge outlet.
--	---

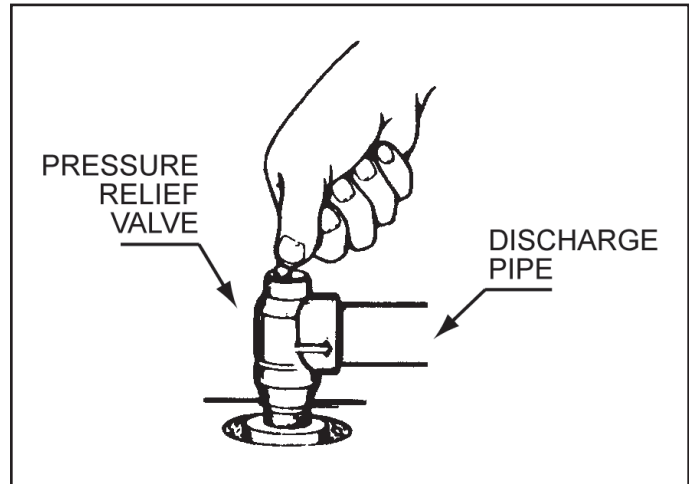

FIGURE 10. PRESSURE RELIEF VALVE TEST

If after manually operating the valve, it fails to completely reset and continues to release water, turn off power to the boiler at the main disconnect switch or breaker. Close the cold water inlet to the boiler and follow the draining instructions in this manual to drain the boiler. Should the pressure relief valve need to be replaced, call the toll free phone number listed on the back of this manual for further technical assistance.

CLEANING AND FLUSHING INSTRUCTIONS

INTERNAL CONTAMINANTS

The hot water system must be internally cleaned and flushed after a new or replacement boiler has been installed to remove contaminants that may have accumulated during installation. This is doubly important when a replacement boiler is installed into an existing system where stop leak or other boiler additives have been used.

Failure to clean and flush the system can produce acid concentrations that become corrosive, cause gases to form that block water circulation or lead to formation of deposits on the boiler surfaces, any of which could result in damage to the system and circulating pump.

All hot water heating systems should be completely flushed with a grease removing solution to assure trouble-free operation.

Pipe joint compounds, soldering paste, grease on tubing and pipe all tend to contaminate a system.

Failure to flush contaminates from a system can cause solids to form on the inside of boiler heat exchangers, create excessive amounts of air and other gases to block circulation, foul various system accessories and even deteriorate circulation seals and impellers.

It is recommended that after installation, the boiler and system when filled should include the proper percentage of cleaning solution related to approximate water volume of the system. Fire and circulate for about one hour and then flush clean with fresh water. Commercial grease removing solutions are available from your distributor.

VENTING MAINTENANCE

It is recommended that the heating surfaces and vent piping of the boiler be checked every six months for dust, deterioration and carbon deposits. Remove all soot or other obstructions from chimney and flue which will retard free draft. Replace any damaged or deteriorated parts of the venting system.

Qualified servicers should follow this procedure when the boiler's external heating surfaces and vent pipe need cleaning.

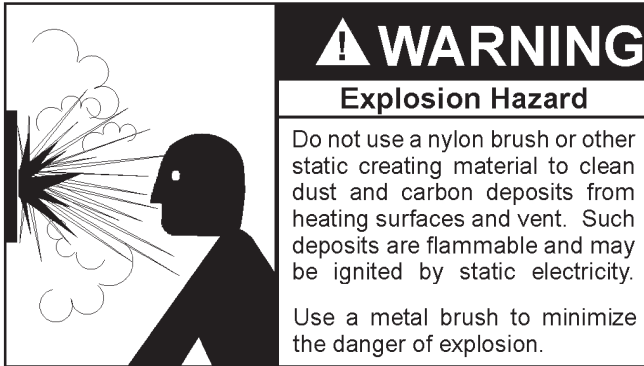

1. Turn off the electrical power (main manual gas shutoff and pilot valves, if applicable).
 - Allow boiler parts and vent to cool before disassembly.
2. Remove the boiler draft diverter and vent pipe running to the chimney.
 - Check parts and chimney for obstructions and clean as necessary.
3. Remove burner from boiler and other metal parts as required to clean and vacuum the heat exchanger and combustion coils.
 - Refer to parts list supplied with this manual for disassembly aid.
4. Reinstall the parts removed in steps 2 and 3.
 - Be sure the vent pipe has a minimum upward pitch of one quarter inch per foot of length (21 mm/m) and is sealed as necessary.
5. Restore electrical power and gas supply to boiler.
 - Place boiler in operation by following the lighting instructions in this manual.
 - Check for gas leaks and proper boiler and vent operation.

NOTES

LIMITED WARRANTY

COMMERCIAL HOT WATER SUPPLY BOILER LIMITED WARRANTY



EFFECTIVE

If within FIVE years after initial installation of the boiler, a heat exchanger or gas burner shall prove upon examination by the warrantor to be defective in material or workmanship, the warrantor, at his option will exchange or repair such part or portion.

For 1 Year, in the event of part failure, we will repair or, at our discretion, replace the defective part.

We warrant this product against defects in materials or workmanship as described in this document if installed within the United States or Canada and provided the product remains at its original place of installation.

Warranty coverage begins the date of installation OR the date of manufacture if installation cannot be verified.

WHAT'S COVERED

Subject to these terms, in the event of defect in materials and/or workmanship resulting in a **heat exchanger leak** during the **first five years**, we will:

- Replace or repair the heat exchanger.

Subject to these terms, in the event of a defect in materials and/or workmanship appearing during the **first year**, we will:

- Repair or, at our discretion, replace any part of the boiler covered under this limited warranty excluding parts subject to normal maintenance (Example: non-electronic anode rod, filter, etc)

Service / labor, shipping, delivery, installation, handling or any other costs are not covered at any time under this warranty.

Any replacement part or product will be warranted only for the unexpired portion of the original boiler's limited warranty period.

WHAT'S NOT COVERED

- Problems caused by improper: gas supply line sizing, gas type, venting, connections, combustion air, voltage, wiring, or fusing
- Failure to follow applicable codes
- Failure to follow printed instructions
- Abuse, misuse, accident, fire, flood, Acts of God
- Improper installation, sizing, delivery, or maintenance
- Claims related to rust, noise, smell, or taste of water
- Failure to conduct authorized factory start up if required
- Alterations to the boiler
- Non-outdoor boilers installed outdoors
- Damages due to a failure to allow for thermal expansion
- Heat exchanger failure due to lack of adequate / proper supply of water
- Boilers moved from their original location
- Service trips to explain proper installation, use, or maintenance of the product/unit or to describe compliance requirements under applicable codes and regulations
- Charges related to accessing your boiler including but not limited to door/wall removal, equipment rental, etc.
- Replacement parts after expiration of this warranty

LIMITATIONS

NOTWITHSTANDING ANYTHING ELSE TO THE CONTRARY, THIS IS YOUR SOLE AND EXCLUSIVE WARRANTY. ALL OTHER WARRANTIES INCLUDING A WARRANTY OF MERCHANTABILITY OR FITNESS FOR PARTICULAR PURPOSE ARE EXPRESSLY DISCLAIMED. SELLER SHALL NOT BE LIABLE FOR ANY CONSEQUENTIAL, INCIDENTAL, SPECIAL, PUNITIVE OR OTHER INDIRECT DAMAGES. TOTAL LIABILITY ARISING AT ANY TIME SHALL NOT EXCEED THE PURCHASE PRICE PAID WHETHER BASED ON CONTRACT, TORT, STRICT LIABILITY OR ANY OTHER LEGAL THEORY.

SERVICE INQUIRIES:

For service inquiries call the telephone number listed below. Be prepared to provide the following information: name, address, and telephone number; the model and serial number of the boiler; proof of installation; and a clear description of the problem.

For your records, fill in the product:

Serial: _____
Model: _____

U.S. Customers:

A. O. Smith Corporation
500 Tennessee Waltz Parkway
Ashland City, Tennessee 37015
800-527-1953
www.hotwater.com

Canadian Customers:

P. O. Box 310 – 768 Erie Street
Stratford (Ontario) N5A 6T3
800-265-8520



25589 Highway 1, McBee, SC 29101
Technical Support: 800-527-1953 • Parts: 800-433-2545 • Fax: 800-644-9306
www.hotwater.com