

GAS FIRED COMMERCIAL WATER HEATERS



25589, Highway 1
McBee, SC 29101



**MODELS: HWH
120, 160, 200, 225
SERIES 100, 101
INSTALLATION - OPERATION
MAINTENANCE - LIMITED WARRANTY
INDOOR ONLY**

WARNING: If the information in these instructions is not followed exactly, a fire or explosion may result causing property damage, personal injury or death.

- Do not store or use gasoline or other flammable vapors and liquids in the vicinity of this or any other appliance.
- **WHAT TO DO IF YOU SMELL GAS:**
 - Do not try to light any appliance.
 - Do not touch any electrical switch; do not use any phone in your building.
 - Immediately call your gas supplier from a neighbor's phone. Follow the gas supplier's instructions.
 - If you cannot reach your gas supplier, call the fire department.
- Installation and service must be performed by a qualified installer, service agency or the gas supplier.

Thank you for buying this energy efficient water heater. We appreciate your confidence in our products.



! WARNING

Read and understand this manual and all Warnings and Cautions within before installing and using this water heater.

Place these instructions adjacent to water heater and notify owner to keep for future reference.

TABLE OF CONTENTS





SAFE INSTALLATION, USE AND SERVICE.....	3	Unusually Tight Construction.....	15
GENERAL SAFETY.....	4	Confined Space.....	15
Grounding Instructions.....	4	Direct Vent Water Heaters.....	15
Correct Gas.....	4	Exhaust Fans.....	15
Precautions.....	4	Louvers and Grilles.....	15
Propane or Liquefied Petroleum (LP) Gas Models.....	4	Fresh Air Openings for Confined Spaces.....	16
High Altitude Installations.....	4	Outdoor Air Through Two Openings.....	16
Field Installed Components.....	4	Outdoor Air Through One Opening.....	16
Abbreviations Used.....	5	Outdoor Air Through Two Horizontal Ducts.....	16
Qualified Installer or Service Agency.....	5	Outdoor Air Through Two Vertical Ducts.....	16
Preparing for the Installation.....	5	Air From Other Indoor Spaces.....	17
INTRODUCTION.....	5	Gas Connections.....	17
DIMENSIONS AND CAPACITY DATA.....	6	VENTING.....	19
CONTROL COMPONENTS.....	7	Standard Venting.....	19
Automatic Reset Limit Control.....	8	Venting System.....	20
Ignition Control.....	8	GAS SUPPLY CONNECTIONS.....	22
Thermal Balancer.....	8	Gas Supply Pipe Connections.....	22
Manual Reset High Limit Switch.....	8	Gas Pressure Requirements.....	22
Tank Temperature Control (not supplied).....	9	Pipe Sizes for Propane Gas.....	22
Thermometers (not supplied).....	9	Purging Gas Line.....	22
Drain Valve (not supplied).....	9	Check Gas Supply Inlet Pressure.....	22
Circulation Pumps (not supplied).....	9	Check for Gas Leaks.....	22
Flow switch (not supplied).....	9	WATER HEATER START UP AND OPERATIONS.....	24
INSTALLATION CONSIDERATIONS.....	11	Precautions.....	24
General.....	11	Checking and Adjusting Input.....	25
Hard Water.....	11	SEQUENCE OF OPERATION FLOWCHART.....	26
Water Piping Diagrams.....	11	OPERATING INSTRUCTIONS.....	27
Internal Contaminants.....	11	TROUBLESHOOTING.....	28
INSTALLATION REQUIREMENTS.....	12	LED Status and Troubleshooting.....	33
Location.....	12	Flame Current Measurement.....	35
Mixing Valves.....	12	GENERAL MAINTENANCE.....	36
Dishwashing Machines.....	13	Manual Reset High Limit Switch Continuity Test.....	36
Closed Water Systems.....	13	Pressure Relief Valve Test.....	36
Thermal Expansion.....	13	Pilot and Main Burner.....	36
Gas supply Systems.....	13	Thermal Balancer (HWH-200, HWH-225).....	38
Supply Gas Regulator.....	13	Venting Maintenance.....	38
Pressure Relief Valve.....	13	Lime Scale Removal.....	38
Combustible Material Storage.....	14	Circulating Pump.....	38
Contaminated Air.....	14	WIRING.....	39
Installation Clearances.....	15	Wiring Connections.....	39
Leveling.....	15	PIPING DIAGRAMS.....	44
System Connections.....	15	NOTES.....	46
Air Requirements.....	15	LIMITED WARRANTY.....	47
Unconfined Space.....	15		

SAFE INSTALLATION, USE AND SERVICE

The proper installation, use and servicing of this water heater is extremely important to your safety and the safety of others.

Many safety-related messages and instructions have been provided in this manual and on your own water heater to warn you and others of a potential injury hazard. Read and obey all safety messages and instructions throughout this manual. It is very important that the meaning of each safety message is understood by you and others who install, use, or service this water heater.

	<p>This is the safety alert symbol. It is used to alert you to potential personal injury hazards. Obey all safety messages that follow this symbol to avoid possible injury or death.</p>
-----------------------------------------------------------------------------------	-------------------------------------------------------------------------------------------------------------------------------------------------------------------------------------------

	<p>DANGER indicates an imminently hazardous situation which, if not avoided, will result in injury or death.</p>
	<p>WARNING indicates a potentially hazardous situation which, if not avoided, could result in injury or death.</p>
	<p>CAUTION indicates a potentially hazardous situation which, if not avoided, could result in minor or moderate injury.</p>
	<p>CAUTION used without the safety alert symbol indicates a potentially hazardous situation which, if not avoided, could result in property damage.</p>

All safety messages will generally tell you about the type of hazard, what can happen if you do not follow the safety message, and how to avoid the risk of injury.

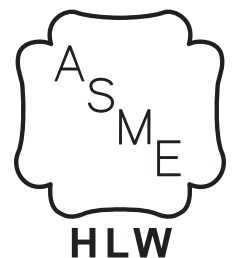

GENERAL SAFETY

GROUNDING INSTRUCTIONS

This water heater must be grounded in accordance with the National Electrical Code, Canadian Electrical Code and/or local codes. This water heater is polarity sensitive; correct wiring is imperative for proper operation.

This water heater must be connected to a grounded metal, permanent wiring system, or an equipment grounding conductor must be run with the circuit conductors and connected to the equipment grounding terminal or lead on the water heater.

CORRECT GAS

Make sure the gas on which the water heater will operate is the same as that specified on the water heater rating plate. Do not install the water heater if equipped for a different type of gas; consult your supplier.

PRECAUTIONS

If the unit is exposed to the following, do not operate until all corrective steps have been made by a qualified service technician:

1. Exposure to fire.
2. If damaged.
3. Firing without water.
4. Sooting.

If the water heater has been exposed to flooding, it must be replaced.

PROPANE OR LIQUEFIED PETROLEUM (LP) GAS MODELS

Water heaters for propane (LP) gas are different from natural gas models. A natural gas water heater will not function safely on propane (LP) gas and no attempt should be made to convert a water heater from natural gas to propane (LP) gas.

Propane (LP) gas must be used with great caution. It is highly explosive and heavier than air. It collects first in the low areas making its odor difficult to detect at nose level. If propane (LP) gas is present or even suspected, do not attempt to find the cause yourself. Leave the building, leaving doors open to ventilate, then call your gas supplier or service agent. Keep area clear until a service call has been made.

At times you may not be able to smell an propane (LP) gas leak. One cause is odor fade, which is a loss of the chemical odorant that gives propane (LP) gas its distinctive smell. Another cause can be your physical condition, such as having a cold or diminishing sense of smell with age. For these reasons, the use of a propane gas detector is recommended.

If you experience an out of gas situation, do not try to relight water heaters yourself. Call your local service agent. Only trained propane (LP) professionals should conduct the required safety checks in accordance with industry standards.

HIGH ALTITUDE INSTALLATIONS

⚠ WARNING	
Breathing Hazard - Carbon Monoxide Gas	
	<ul style="list-style-type: none">• Special consideration must be taken with installations above 2000 feet (610 m).• Please contact an A.O. Smith qualified service agent to obtain the proper setup and instructions before lighting.• Failure to implement the proper setup will result in improper and inefficient operation of the appliance resulting in production of increased levels of carbon monoxide gas in excess of the safe limits which could result in serious personal injury or death.
Breathing carbon monoxide can cause brain damage or death. Always read and understand instruction manual.	

Verify that the elevation of the installation is within the altitude range stamped on the rating plate of the appliance.

U.S. Requirements

If the altitude range stamped on the appliance nameplate does not match the installation elevation, contact Technical Support at 1-800-527-1953 for guidance.

Canadian Requirements

If the altitude range stamped on the appliance nameplate does not match the installed elevation, contact the gas supplier for guidance.

FIELD INSTALLED COMPONENTS

When installing the water heater, the following components must be installed:

- Circulating Pump
- Storage Tank Temperature Control
- Storage Tank (Temperature & Pressure Relief Valve)
- Thermometers
- Flow Switch
- Drain Valve

INTRODUCTION

Thank You for purchasing this water heater. Properly installed and maintained, it should give you years of trouble free service.

ABBREVIATIONS USED

Abbreviations found in this Instruction Manual include :

- ANSI - American National Standards Institute
- ASME - American Society of Mechanical Engineers
- NEC - National Electrical Code
- NFPA - National Fire Protection Association
- UL - Underwriters Laboratory
- CSA - Canadian Standards Association
- AHRI - Air Conditioning, Heating and Refrigeration Institute

QUALIFIED INSTALLER OR SERVICE AGENCY

Installation and service of this water heater requires ability equivalent to that of a Qualified Agency (as defined by ANSI below) in the field involved. Installation skills such as plumbing, air supply, venting, gas supply and electrical supply are required in addition to electrical testing skills when performing service.

ANSI Z223.1 2006 Sec. 3.3.83: "Qualified Agency" - "Any individual, firm, corporation or company that either in person or through a representative is engaged in and is responsible for (a) the installation, testing or replacement of gas piping or (b) the connection, installation, testing, repair or servicing of appliances and equipment; that is experienced in such work; that is familiar with all precautions required; and that has complied with all the requirements of the authority having jurisdiction."

If you are not qualified (as defined by ANSI above) and licensed or certified as required by the authority having jurisdiction to perform a given task do not attempt to perform any of the procedures described in this manual. If you do not understand the instructions given in this manual do not attempt to perform any procedures outlined in this manual.

PREPARING FOR THE INSTALLATION

1. Read the entire manual before attempting to install or operate the water heater. Pay close attention to the General Safety Information on page 4. If you don't follow the safety rules, the water heater may not operate safely. It could cause property damage, injury and/or death.

This manual contains instructions for the installation, operation, and maintenance of the water heater. It also contains warnings throughout the manual that you must read and be aware of. All warnings and all instructions are essential to the proper operation of the water heater and your safety.

Detailed installation diagrams are also found in this manual. These diagrams will serve to provide the installer with a reference. It is essential that all venting, water piping, gas piping and wiring be installed as shown.

Particular attention should be given to the installation

of thermometers at the locations indicated in the piping diagrams as these are necessary for checking the operation of the water heater.

The principal components of the water heater are identified in Control Components on pages 7, 8, 9 and 10 in this manual. Use this reference to locate and identify various components on the water heater.

See Troubleshooting on page 28. By using this information the user may be able to make minor operational adjustments and avoid unnecessary service calls. However, service and diagnostic procedures should only be performed by a Qualified Service Agency.

Note: Costs to correct installation errors are not covered under the limited warranty.

2. Be sure to turn off power when working on or near the electrical system of the water heater. Never touch electrical components with wet hands or when standing in water.
3. The installation must conform to all instructions contained in this manual and the local code authority having jurisdiction. These shall be carefully followed in all cases. Authorities having jurisdiction should be consulted before installation begins if there are any questions regarding compliance with local, state or national codes.

In the absence of local codes, the installation must comply with the current editions of the National Fuel Gas Code, ANSI Z223.1/NFPA 54 and the National Electrical Code, NFPA 70 or CAN/CSA-B149.1, the Natural Gas and Propane Installation Code and CSA C22.1, the Canadian Electrical Code. All documents are available from the Canadian Standards Association, 8501 East Pleasant Valley Road, Cleveland, OH 44131. NFPA documents are also available from the National Fire Protection Association, 1 Batterymarch Park, Quincy, MA 02269.

4. If after reading this manual you have any questions or do not understand any portion of the instructions, call the toll free number on the back cover of this manual for technical assistance. In order to expedite your request, please have the full Model, Serial and Series number of the water heater you are working with available for the technician. This information is located on the water heater's rating label.
5. Carefully plan the placement of the water heater. Examine the location to ensure that it complies with the requirements in Location on page 12.
6. For installation in California this water heater must be braced or anchored to avoid falling or moving during an earthquake. See instructions for correct installation procedures. Instructions may be obtained from California Office of the State Architect, 1102 Q Street, Suite 5100, Sacramento, CA 95811.

DIMENSIONS AND CAPACITY DATA

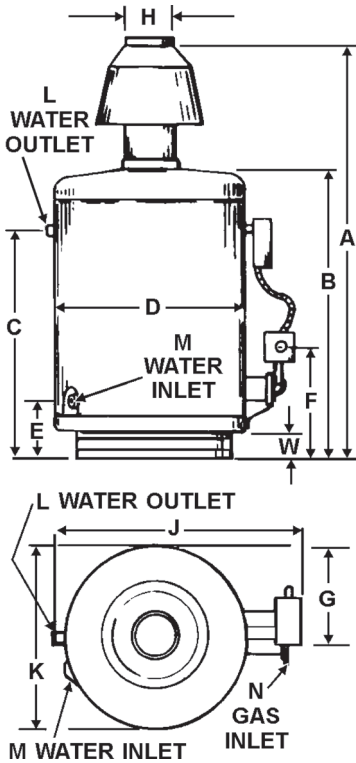

FIGURE 1. DIMENSIONS

TABLE 1. ROUGH-IN DIMENSIONS

Models Dimensions	HWH-120		HWH-160		HWH-200		HWH-225	
	Inches	mm	Inches	mm	Inches	mm	Inches	mm
A	49 3/8	1254	50 1/8	1273	53 1/4	1353	60	1524
B	30 3/8	772	30 3/8	772	33 1/8	841	33 1/8	841
C	23 5/8	600	23 5/8	600	27 1/8	689	27 1/8	689
D	20 3/4	527	20 3/4	527	20 3/4	527	20 3/4	527
E	5 1/2	140	5 1/2	140	5 1/2	140	5 1/2	140
F	10	254	10	254	10	254	10	254
G	11 13/16	300	11 13/16	300	11 13/16	300	11 13/16	300
H	6	152	7	178	7	178	7	178
J	26 11/16	678	26 11/16	678	26 11/16	678	26 11/16	678
K	20 3/4	527	20 3/4	527	20 3/4	527	20 3/4	527
L	1 1/4 NPT		1 1/4 NPT		1 1/4 NPT		1 1/4 NPT	
M	1 NPT		1 NPT		1 NPT		1 NPT	
N	1/2 NPT		1/2 NPT		1/2 NPT		1/2 NPT	
W	1 3/4	44	1 3/4	44	1 3/4	44	1 3/4	44
Approx. Shipping Weight	120 lbs.	54 Kg.	155 lbs.	70 Kg.	165 Lbs.	75 Kg.	175 lbs.	79 Kg.

TABLE 2. RECOVERY CAPACITIES

Model	Input		U.S. Gallons/Hr and Litres/Hr. at TEMPERATURE RISE INDICATED						
			T °F	20	30	40	50	60	70
	BTUH	KW	T °C	11	17	22	28	33	39
HWH 120	120000	35	GPH	576	385	288	230	192	164
			LPH	2179	1457	1090	872	726	623
HWH 160	160000	47	GPH	767	513	384	307	256	219
			LPH	2905	1943	1453	1162	968	830
HWH 200	199000	58	GPH	954	638	477	382	318	273
			LPH	3614	2417	1807	1445	1205	1032
HWH 225	225000	66	GPH	1079	722	540	432	360	308
			LPH	4086	2732	2043	1634	1362	1167

NOTE: A temperature rise of 30°F is recommended for all models.

ELECTRICAL REQUIREMENTS

TABLE 3. ELECTRICAL REQUIREMENTS: HWH-120 THROUGH 225

Models	Supply Voltage (Volts)	Frequency (Hz)	Current (AMPS)
All	120	60	<5

GAS REQUIREMENTS

TABLE 4. GAS REQUIREMENTS: HWH-120 THROUGH 225

Models	Minimum Inlet Gas Pressure		Maximum Inlet Gas Pressure		Manifold Pressure	
	in. W.C.	kPa	in. W.C.	kPa	in. W.C.	kPa
All - Natural Gas	4.5	1.1	13.0	3.2	3.5	0.87
All - Propane	10	2.5	13.5	3.4	10	2.5

CONTROL COMPONENTS

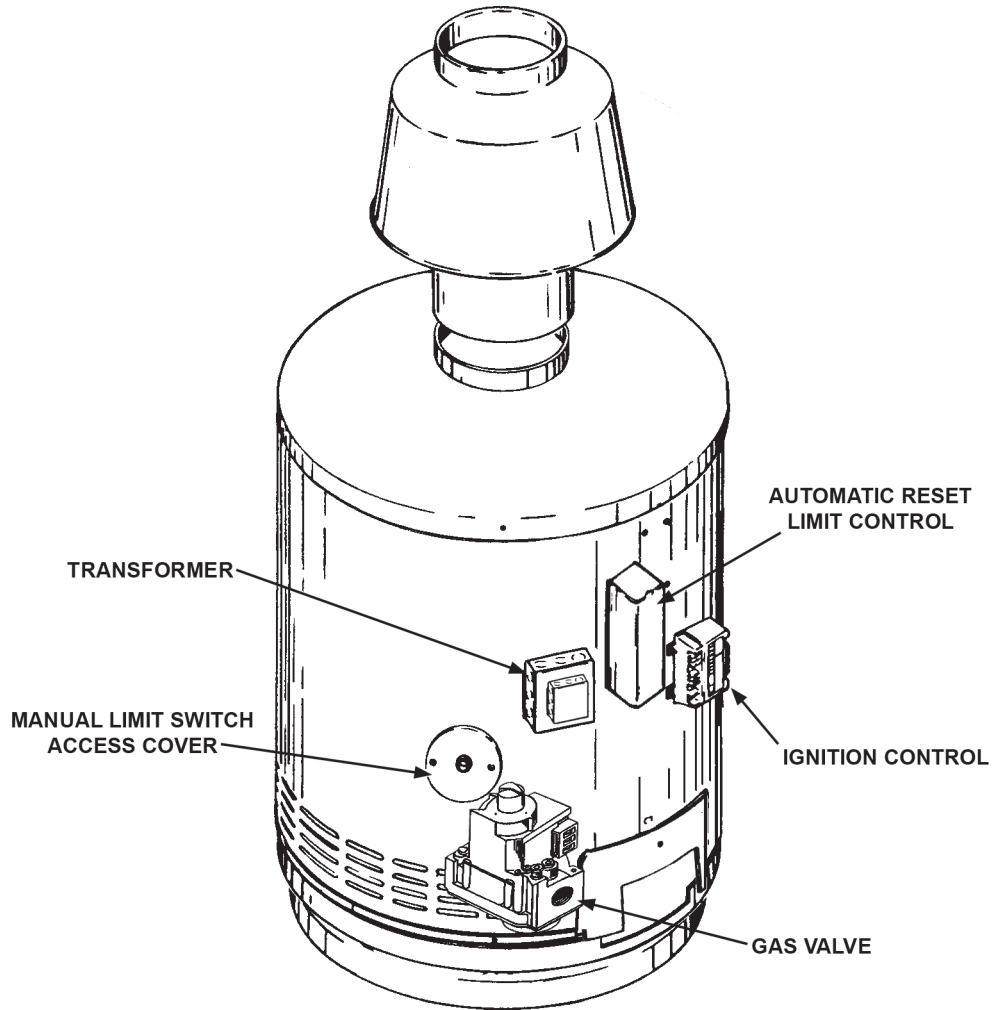

FIGURE 2. COMPONENT LOCATIONS

AUTOMATIC RESET LIMIT CONTROL

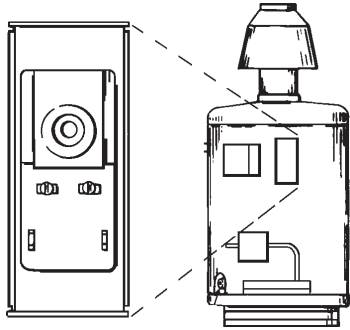

FIGURE 3. AUTO RESET LIMIT CONTROL

The automatic reset limit control, Figure 3, is an automatic safety device that activates at a water temperature of approximately 195°F (91°C). This limits the water outlet temperature to a maximum of 200°F (93°C).

The device is wired in series with the gas valve. The control will automatically reset when the outlet water temperature decreases to approximately 190°F (88°C).

Should the automatic reset limit control activate during a heating cycle, the water heater's gas valve will close; extinguishing the main burners. The pilot burner will also be extinguished. The circulating pump will continue operating as long as the storage tank thermostat continues to "call for heat". When the outlet water temperature from the water heater drops to 190°F (88°C) or below, the control module will begin an ignition cycle that will relight the pilot burner and main burners if the storage tank thermostat continues to call for heat. Otherwise, the normal operating cycle will resume on the thermostat's next call for heat.

IGNITION CONTROL

The Honeywell S-8600 ignition control contains the electronic components of the system and also serves as a control wiring system for the controls mounted on the water heater. The ignition control performs the following functions:

1. Checks for safe-start by sensing for a false flame condition on start-up.
2. Generates a potential of 15,000 volts for spark ignition of the pilot burner.
3. Opens the pilot valve.
4. Discontinues ignition spark when the pilot flame is established. The S-8600 control used on propane gas models provides safety lockout if the pilot fails to ignite within the pilot flame establishing period. The S-8600 control used on natural gas models continues trial for ignition until pilot flame is established.
5. After proof of pilot flame, opens the main valve.
6. On a power loss, shuts the water heater down. When power is restored it will begin a new ignition cycle.
7. On a loss of flame, shuts off main gas and starts trial for pilot ignition.

Please refer to TROUBLESHOOTING SECTION for more information.

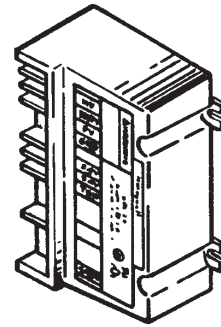

FIGURE 4. IGNITION CONTROL

THERMAL BALANCER

The thermal balancer (standard on Models HWH-200 and HWH-225) is a delay relay used to control the pump on the water circulation system. The thermal balancer provides an immediate start for the pump but delays the shutoff of the pump for approximately 2 minutes after the burner has turned off. The extra pump operating time helps to recover residual heat from the heat exchanger to improve the efficiency of the appliance and also to balance the heat exchanger temperature with the tank temperature after shutdown.

MANUAL RESET HIGH LIMIT SWITCH

This water heater is equipped with a manual reset high limit switch, located under the small cover on the side of the jacket, see Figure 5. This device provides positive shutdown of the water heater in the event of water heater or system malfunction. Should the temperature of the copper tube reach 210°F (99°C), the high limit switch will activate, the gas control valve will close, the pilot and main burners will be extinguished. If the high limit switch should shut off unit, check the following conditions:

- No water in water heater.
- Restricted water flow through the water heater.
- Improper wiring (water heater firing without circulating pump operating).
- Pump failure.

After correcting failure condition remove the switch cover and push the reset button. The high limit switch may be reset after the coil surface decreases to 204°F (96°C).

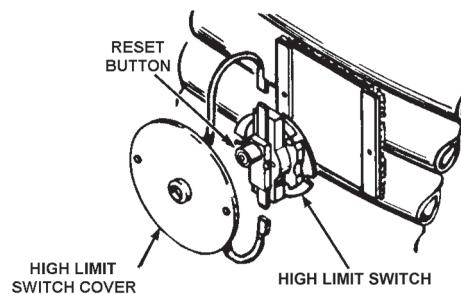
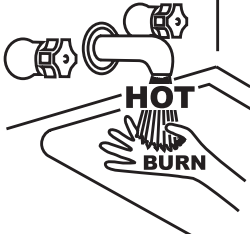

FIGURE 5. MANUAL RESET HIGH LIMIT SWITCH

TANK TEMPERATURE CONTROL (NOT SUPPLIED)

The water temperature in the storage tank is controlled by the Tank Temperature Control. The sensing element is mounted inside the hot water storage tank.

	⚠ DANGER
	Water temperature over 125°F (52°C) can cause severe burns instantly resulting in severe injury or death.
	Children, the elderly and the physically or mentally disabled are at highest risk for scald injury.
	Feel water before bathing or showering.
Temperature limiting devices such as mixing valves must be installed when required by codes and to ensure safe temperatures at fixtures.	

The tank temperature control is adjustable from 100°F (38°C) to 190°F (88°C). It is recommended that lower water temperatures be used to avoid the risk of scalding. It is further recommended, in all cases, that the water temperature be set for the lowest temperature which satisfies the user's hot water needs. This will also provide the most energy efficient operation of the water heater and minimize scale formation.

The water heater should be located in an area where the general public does not have access to set temperatures. Setting the water temperature at 120°F (49°C) will reduce the risk of scalds.

A change in water temperature in the storage tank lower than the Tank Temperature Control setting will cause the sensor to close its contacts and consequently energize the water heater.

If the Tank Temperature Control is out of calibration, replace it with a new one; do not attempt to fix this control.

THERMOMETERS (NOT SUPPLIED)

Thermometers should be obtained and field installed as shown in the installation diagrams.

Thermometers are installed in the system as a means of detecting a possible liming condition in the water heater. Record the temperature rise at initial start-up for future reference. A temperature rise of 30°F (17°C) is recommended for all models at initial start-up. An increase of 5°F (3°C) over the recorded temperature rise through the water heater is an indication that lime is present. The term "temperature rise" designates the difference between the water heater inlet and outlet water temperature.

DRAIN VALVE (NOT SUPPLIED)

A drain valve must be obtained and installed on each water heater and tank for draining purposes.

CIRCULATION PUMPS (NOT SUPPLIED)

A circulating pump is used to circulate water between the storage tank and the water heater. See Water Piping Diagrams in this manual for installation location of circulating pumps.

See the Circulation Pump Wiring Diagrams in this manual for electrical hookup information. Install in accordance with the current edition of the National Electrical Code, NFPA 70 or the Canadian Electrical Code, CSA C22.1.

Constant circulating pump operation of the water heater voids the warranty. Constant water flow through the unit will "wash" away the copper's natural protective coating. This is called velocity erosion. This erosion is not as great a problem when

intermittent circulating operation is used per the recommended installation procedure. Constant circulation of water through the building's system main is permissible as long as the water does not constantly flow through the water heater.

Stainless steel circulating pumps are recommended for use with commercial water heaters.

Some circulating pumps are manufactured with sealed bearings and do not require further lubrication. Some circulating pumps must be periodically oiled. Refer to the pump manufacturer's instructions for lubrication requirements.

CIRCULATING PUMP WIRING DIAGRAM
STORAGE TANK OR BUILDING RECIRCULATION

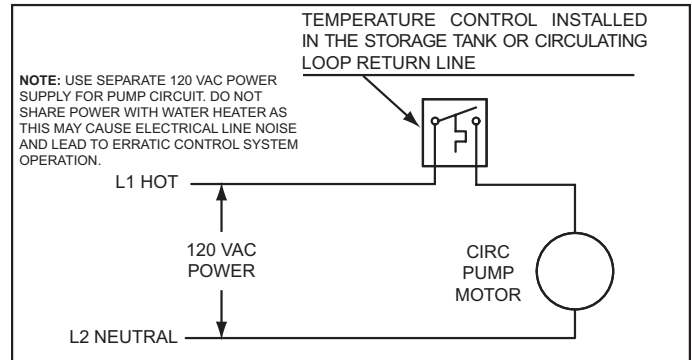

CIRCULATING PUMP WIRING DIAGRAM
DISHWASHER LOOP WITH TOGGLE SWITCH

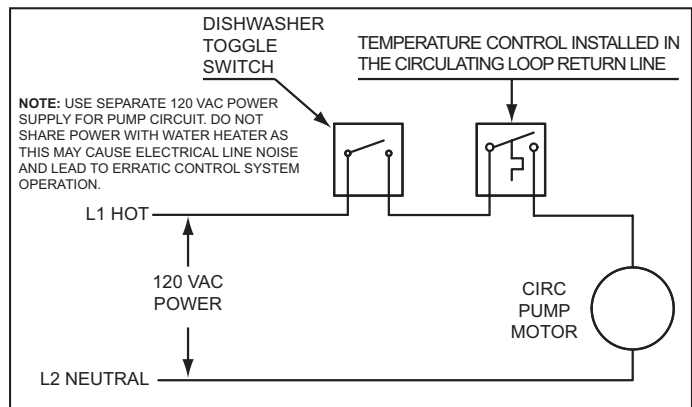

FIGURE 6. CIRCULATING PUMP WIRING DIAGRAMS

FLOW SWITCH (NOT SUPPLIED)

The flow switch is a safety device which must be installed at the water outlet of the unit to prevent main burner operation in the event of inadequate water flow through the unit.

An accessory package containing a flow switch is available for this application.

This switch may be mounted in a horizontal pipe line or a vertical pipe line with upward water flow. Do not install the switch where the water flow is downward.

For proper performance mount the switch in a section of pipe where there is a straight run of at least 5 pipe diameters on each side of the flow switch (i.e. do not locate adjacent to valves, elbows, orifices, etc.).

The flow switch shall be mounted in a standard 1" x 1" x 1" tee for the 120, 160 and 200 models. The 225 model should be installed with a 1 1/4" x 1 1/4" x 1" reducing tee. Install the flow switch in the branch (top) opening of the reducing tee and provide adequate paddle length in the flow stream. The paddle must be adjusted or trimmed to the size of the pipe in which it will be installed, see Figure 7.

Any part of the paddle must not touch the pipe or any restrictions in the pipe. Screw the flow switch in position so the flat of the paddle is at right angles to the flow. The arrow on the side case must point in the direction of the flow.

TABLE 5. FLOW SWITCH

Model Number	Minimum Flow Rate			
	Contacts Closed (Flow)		Contacts Open (No Flow)	
	GPM	LPM	GPM	LPM
HWH-120 through 225	4.5	17.0	3.5	13.2

The flow switch may be field adjusted to obtain higher minimum flow rates than those shown in Table 5.

To adjust the flow rate setting:

1. Remove the flow switch cover.
2. For higher flow rate - turn the range adjusting screw clockwise.
3. For lower flow rate-turn the range adjusting screw counterclockwise.

The switch is factory set at approximately the minimum flow rate, refer to Table 5. It must not be set lower than the factory setting as this may result in the switch failing to return at a 'no flow' condition.

4. Replace flow switch cover.

Where units are installed in multiples, each water heater must be individually protected by a flow switch.

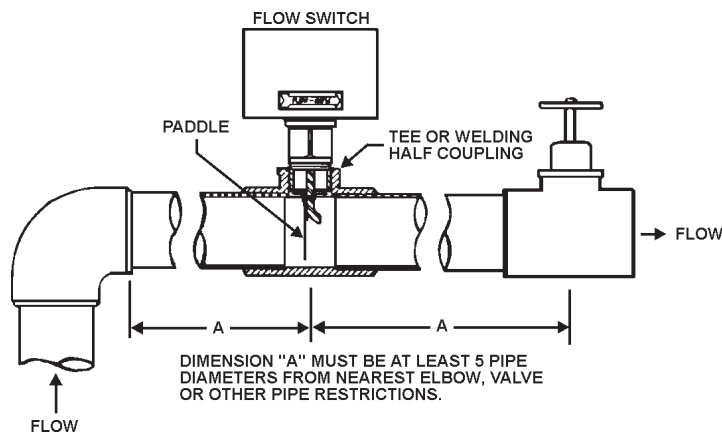
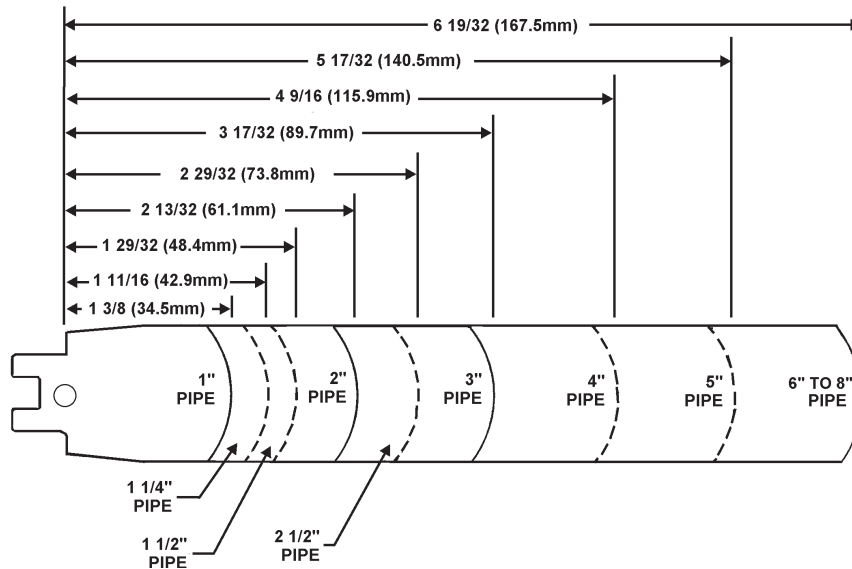

FIGURE 7. FLOW SWITCH

INSTALLATION CONSIDERATIONS

GENERAL

If the system is to be filled with water for testing or other purposes during cold weather and before actual operation, care must be taken to prevent freezing of water in the system. Failure to do so may cause the water in the system to freeze with resulting damage to the system. Damage due to freezing is not covered by the warranty.

Before locating the water heater:

1. Check for nearby connection to:
 - System water piping
 - Venting connections
 - Gas supply piping
 - Electrical power
2. Locate the water heater so that if water connections should leak, water damage will not occur. When such locations cannot be avoided, it is recommended that a suitable drain pan, adequately drained, be installed under the appliance. The pan must not restrict combustion air flow. Under no circumstances is the manufacturer to be held responsible for water damage in connection with this appliance, or any of its components.
3. Check area around the water heater. Remove any combustible materials, gasoline and other flammable liquids.
4. Make sure the gas control system components are protected from dripping or spraying water or rain during operation or service.

HARD WATER

Where hard water conditions exist, water softening or the threshold type of water treatment is recommended. This will protect dishwashers, coffee urns, water heaters, water piping and other equipment. See the General Maintenance section in this manual for information concerning lime scale removal.

WATER PIPING DIAGRAMS

This manual provides detailed water piping diagrams for typical methods of application for the water heaters, see Water Piping Diagrams beginning on page 44.

The water heater must be installed with a separate storage tank. A pump provides water circulation between the storage tank and the water heater. Adjust flow by throttling a full port ball valve installed in the circulating line on the outlet side of the pump. Never throttle flow on the suction side of a pump. See the Water Piping Diagrams beginning on page 44.

INTERNAL CONTAMINANTS

The system must be internally cleaned and flushed after a new or replacement water heater has been installed, to remove contaminants that may have accumulated during installation.

Failure to flush contaminants from a system can cause solids to form on the inside of heat exchangers, create excessive blockage of water circulation, and deteriorate pump seals and impellers.

INSTALLATION REQUIREMENTS

LOCATION

When installing the water heater, consideration must be given to proper location. The location selected should provide adequate air supply and be as centralized with the piping system as possible. The location must be as close as practicable to a chimney or gas vent. This location should also be such that the gas ignition system components are protected from water dripping, spraying, etc.) during water heater operation and service (circulating pump replacement, control replacement, etc.).

⚠ CAUTION

Property Damage Hazard

This water heater should not be installed on carpeting.

This water heater should not be located in an area where it may be subject to freezing.

This water heater must be located near a floor drain. It should be located in an area where leakage from the water heater or connections will not result in damage to the adjacent area or to lower floors of the structure.

⚠ WARNING

Fire Hazard



Flammable items, pressurized containers, or any other potential fire hazard articles must never be placed on or adjacent to the water heater. Open containers or flammable material should not be stored or used in the same room with the water heater.

⚠ DANGER

Fire Explosion Hazard



There is a risk of fire or explosion in areas where gasoline, other flammable liquids, or engine driven equipment and vehicles are stored, operated, or repaired when a fuel burning appliance such as a water heater is operated.

Flammable vapors are heavy and travel along the floor. They may be ignited by sparks causing fire or explosion.

Some local codes permit operation of gas appliances if installed 18 inches (45.7 cm) or more above the floor. This may reduce the risk if location in such an area cannot be avoided.

This water heater is intended for indoor installation only and should not be installed where freezing temperatures or any moisture could damage the external components of the water heater.

MIXING VALVES

⚠ DANGER

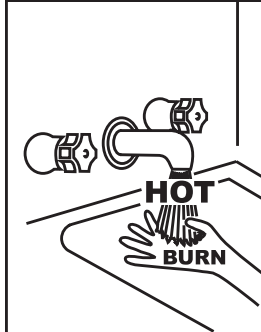

Water temperature over 125°F (52°C) can cause severe burns instantly resulting in severe injury or death.

Children, the elderly and the physically or mentally disabled are at highest risk for scald injury.

Feel water before bathing or showering.

Temperature limiting devices such as mixing valves must be installed when required by codes and to ensure safe temperatures at fixtures.

Water heated to a temperature which will satisfy clothes washing, dish washing, and other sanitizing needs can scald and cause permanent injury upon contact. Short repeated heating cycles caused by small hot water uses can cause temperatures at the point of use to exceed the water heater's temperature setting by up to 20°F (11°C).

Some people are more likely to be permanently injured by hot water than others. These include the elderly, children, the infirm and the physically/mentally disabled. Table 6. shows the approximate time-to-burn relationship for normal adult skin. If anyone using hot water provided by the water heater being installed fits into one of these groups or if there is a local code or state law requiring a certain water temperature at the point of use, then special precautions must be taken.

In addition to using the lowest possible temperature setting that satisfies the demand of the application a Mixing Valve should be installed at the water heater (see Figure 8.) or at the hot water taps to further reduce system water temperature.

Mixing valves are available at plumbing supply stores. Consult a Qualified Installer or Service Agency. Follow mixing valve manufacturer's instructions for installation of the valves.

TABLE 6.

Water Temperature °F	Time for 1st Degree Burn (Less Severe Burns)	Time for Permanent Burns 2nd & 3rd Degree (Most Severe Burns)
110	(normal shower temp.)	
116	(pain threshold)	
116	35 minutes	45 minutes
122	1 minute	5 minutes
131	5 seconds	25 seconds
140	2 seconds	5 seconds
149	1 second	2 seconds
154	instantaneous	1 second

(U.S. Government Memorandum, C.P.S.C., Peter L. Armstrong, Sept. 15, 1978)

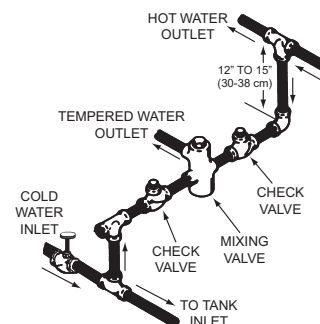

FIGURE 8.

DISHWASHING MACHINES

All dishwashing machines meeting the National Sanitation Foundation requirements are designed to operate with water flow pressures between 15 and 25 pounds per square inch (103 kPa and 173 kPa). Flow pressures above 25 pounds per square inch (173 kPa), or below 15 pounds per square inch (103 kPa), will result in improperly sanitized dishes. Where pressures are high, a water pressure reducing or flow regulating control valve should be used in the 180°F (82°C) line to the dishwashing machine and should be adjusted to deliver water pressure between these limits.

The National Sanitation Foundation also recommends circulation of 180°F (82°C) water. The circulation flow rate should be just enough to provide 180°F (82°C) water at the point of take-off to the dishwashing machine.

Adjust flow by throttling a full port ball valve installed in the circulating line on the outlet side of the pump. Never throttle flow on the suction side of a pump. See Water Piping Diagrams in this manual.

CLOSED WATER SYSTEMS

Water supply systems may, because of code requirements or such conditions as high line pressure, among others, have installed devices such as pressure reducing valves, check valves, and back flow preventers. Devices such as these cause the water system to be a closed system.

THERMAL EXPANSION

As water is heated, it expands (thermal expansion). In a closed system the volume of water will expand when it is heated. As the volume of water expands there will be a corresponding increase in water pressure due to thermal expansion. Thermal expansion can cause premature tank failure (leakage). This type of failure is not covered under the limited warranty. Thermal expansion can also cause intermittent Temperature-Pressure Relief Valve operation: water discharged from the valve due to excessive pressure build up. This condition is not covered under the limited warranty. The Temperature-Pressure Relief Valve is not intended for the constant relief of thermal expansion.

A properly sized thermal expansion tank must be installed on all closed systems to control the harmful effects of thermal expansion. Contact a local plumbing service agency to have a thermal expansion tank installed.

GAS SUPPLY SYSTEMS

Low pressure building gas supply systems are defined as those systems that cannot under any circumstances exceed 14" W.C. (3.5 kPa) (1/2 PSI Gauge). These systems do not require pressure regulation. Measurements should be taken to insure that gas pressures are stable and fall within the requirements stated on the water heater rating plate. Readings should be taken with all gas burning equipment off (static pressure) and with all gas burning equipment running at maximum rate (dynamic pressure). The gas supply pressure must be stable within 1.5" W.C. (0.37 kPa) from static to dynamic pressure to provide good performance. Pressure drops that exceed 1.5" W.C. (0.37 kPa) may cause rough starting, noisy combustion or nuisance outages. Increases or spikes in static pressure during off cycles may cause failure to ignite or in severe cases damage to appliance gas valves. If your low pressure system does NOT meet these requirements, the installer is responsible for the corrections.

High Pressure building supply systems use pressures that exceed 14" W.C. (3.5 kPa) (1/2 PSI Gauge). These systems

must use field supplied regulators to lower the gas pressure to less than 14" W.C. (3.5 kPa) (1/2 PSI Gauge). Appliances require gas regulators that are properly sized for the water heater input and deliver the rating plate specified pressures. Gas supply systems where pressure exceeds 5 PSI (34.5 kPa) often require multiple regulators to achieve desired pressures. Systems in excess of 5 PSI (34.5 kPa) building pressure should be designed by gas delivery professionals for best performance. Water heaters connected to gas supply systems that exceed 14" W.C. (3.5 kPa) (1/2 PSI Gauge) at any time must be equipped with a gas supply regulator.

All models require a minimum gas supply pressure of 4.5" W.C. (1.1 kPa) for Natural Gas and 10" W.C. (2.5 kPa) for Propane. The minimum supply pressure is measured while gas is flowing (dynamic pressure). The supply pressure should never fall below 4.5" W.C. (1.1 kPa) for Natural Gas and 10" W.C. (2.5 kPa) for Propane. The supply pressure should be measured with all gas fired appliances connected to the common main firing at full capacity. If the supply pressure drops more than 1.5" W.C. (0.37 kPa) as gas begins to flow to the water heater then the supply gas system including the gas line and/or the gas regulator may be restricted or undersized. See Supply Gas Regulator section and Gas Piping section of this manual. The gas valve on all models has a maximum gas supply pressure limit of 14" W.C. (3.5 kPa) The maximum supply pressure is measured while gas is not flowing (static pressure).

SUPPLY GAS REGULATOR

The maximum allowable gas supply pressure for this water heater is 13" W.C. (3.2 kPa) for Natural gas and 13.5" W.C. (3.4kPa) for Propane gas. Install a positive lock-up gas pressure regulator in the gas supply line if inlet gas pressure can exceed these maximum allowable pressures at any time. Regulators must be sized/used according to manufacturer's specifications.

If a positive lock-up regulator is required follow these instructions:

1. Positive lock-up gas pressure regulators must be rated at or above the input Btu/hr rating of the water heater they supply.
2. Positive lock-up gas pressure regulator(s) should be installed no closer than 3 equivalent feet (1 meter) and no farther than 8 equivalent feet (2.4 meters) from the water heater's inlet gas connection.
3. After installing the positive lock-up gas pressure regulator(s) an initial nominal supply pressure setting of 7.0" W.C. (1.7 kPa) for Natural Gas and 12" W.C. (3.0 kPa) for Propane while the water heater is operating is recommended and will generally provide good water heater operation. Some additional adjustment maybe required later to maintain a steady gas supply pressure.
4. When installing multiple water heaters in the same gas supply system it is recommended that individual positive lock-up gas pressure regulators be installed at each unit.

PRESSURE RELIEF VALVE

An ASME rated pressure relief valve is furnished with the water heater. The pressure relief valve is to be installed in the hot water outlet line as near to the water heater as possible. Never operate the gas burner without being certain the water heater is filled with water and a properly sized pressure relief valve is installed.

The pressure rating of the relief valve should be equal to or less than the rated pressure capacity of any component in the system including the water heater. Should the valve need to be replaced, call the toll free phone number listed on the back of this manual for further technical assistance.

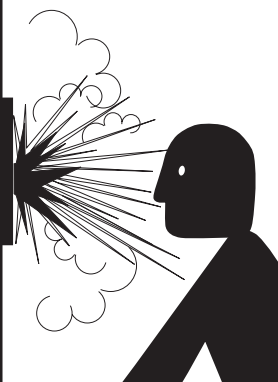
	⚠ WARNING
	Explosion Hazard
	<ul style="list-style-type: none"> • Relief Valve must comply with ASME code. • Properly sized Relief Valve must be installed. • Can result in overheating and excessive tank pressure. • Can cause serious injury or death.

A discharge pipe from the relief valve should terminate at an adequate floor drain. Do not thread, plug, or cap the end of the drain line.



CAUTION
Water Damage Hazard
<ul style="list-style-type: none"> • Pressure Relief Valve discharge pipe must terminate at adequate drain.

The Discharge Pipe:

- Shall not be smaller in size than the outlet pipe size of the valve, or have any reducing couplings or other restrictions.
- Shall not be plugged or blocked.
- Shall not be exposed to freezing temperatures.
- Shall be of material listed for hot water distribution.
- Shall be installed so as to allow complete drainage of both the relief valve and the discharge pipe.
- Must terminate a maximum of six inches above a floor drain or external to the building. In cold climates, it is recommended that the discharge pipe be terminated at an adequate drain inside the building.
- Shall not have any valve or other obstruction between the relief valve and the drain.

Once the water heater is installed and filled with water and the system is pressurized, manually test the operation of the pressure relief valve. See the maintenance section of this manual for instructions.

COMBUSTIBLE MATERIAL STORAGE

⚠ WARNING	
Fire or Explosion Hazard	
<ul style="list-style-type: none"> • Do not store or use gasoline or other flammable vapors and liquids in the vicinity of this or any other appliance. • Avoid all ignition sources if you smell gas. • Do not expose water heater controls to excessive gas pressure. • Use only the gas shown on the water heater rating label. • Maintain required clearances to combustibles. • Keep ignition sources away from faucets after extended periods of non-use. 	
	<p>Read instruction manual before installing, using or servicing water heater.</p>
	

Keep appliance area clear and free of combustible materials, gasoline and other flammable vapors and liquids.

CONTAMINATED AIR

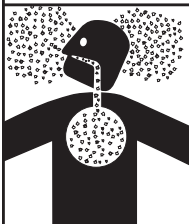
⚠ WARNING	
Breathing Hazard - Carbon Monoxide Gas	
	<ul style="list-style-type: none"> • Install water heater in accordance with the Instruction Manual and NFPA 54 or CAN/CSA-B149.1. • To avoid injury, combustion and ventilation air must be taken from outdoors. • Do not place chemical vapor emitting products near water heater.
<p>Breathing carbon monoxide can cause brain damage or death. Always read and understand instruction manual.</p>	

Corrosion of the heat exchanger and vent system may occur if air for combustion contains certain chemical vapors. Such corrosion may result in failure and risk of asphyxiation.

Combustion air that is contaminated can greatly diminish the life span of the water heater and water heater components such as igniters and burners. Propellants of aerosol sprays, beauty shop supplies, water softener chemicals and chemicals used in dry cleaning processes that are present in the combustion, ventilation or ambient air can cause such damage.

Do not store products of this sort near the water heater. Air which is brought in contact with the water heater should not contain any of these chemicals. If necessary, uncontaminated air should be obtained from remote or outdoor sources. The limited warranty is voided when failure of water heater is due to a corrosive atmosphere. (See limited warranty for complete terms and conditions).

INSTALLATION CLEARANCES

These water heaters are approved for installation on combustible flooring in an alcove with minimum clearance to combustibles or noncombustibles shown in Table 7.

TABLE 7. INSTALLATION CLEARANCES

	All Models
TOP	44" (112 cm)
SIDES	6" (15 cm)
REAR	6" (15 cm)
VENT	6" (15 cm)

2 inches (51 mm) clearance is allowable from combustible construction for hot water pipes.

When the appliance is installed directly on carpeting, the appliance shall be installed on a metal or wood panel extending beyond the full width and depth of the appliance by at least 3 inches (76.2 mm) in any direction. If the appliance is installed in an alcove or closet, the entire floor shall be covered by the panel. The panel must be strong enough to carry the weight of the water heater when full of water.

Sufficient area should be provided at the front and rear of the unit for proper servicing. Clearances of 24 inches (61 cm) in the rear and 48 inches (122 cm) in the front are required by code. In a utility room installation, the door shall be wide enough to allow the water heater to enter or to permit the replacement of another appliance such as a water heater.

LEVELING

Each unit should be checked after installation to be certain that it is level prior to starting the unit.

If the unit is not level, obtain and insert shims under the base ring of the unit to correct this condition.

SYSTEM CONNECTIONS

The system installation must conform to these instructions and to the requirements of the local code authority having jurisdiction. Good practice requires that all heavy piping be supported.

AIR REQUIREMENTS

⚠ WARNING

Breathing Hazard - Carbon Monoxide Gas



- Install appliance in accordance with the Instruction Manual and NFPA 54 or CAN/CSA-B149.1.
- To avoid injury, combustion and ventilation air must be taken from outdoors.
- Do not place chemical vapor emitting products near the water heater.

Breathing carbon monoxide can cause brain damage or death. Always read and understand instruction manual.

For safe operation an adequate supply of fresh uncontaminated air for combustion and ventilation must be provided.

An insufficient supply of air can cause recirculation of combustion products resulting in contamination that may be hazardous to life. Such a condition often will result in a yellow, luminous burner flame, causing sooting of the combustion chamber, burners and flue tubes and creates a risk of asphyxiation.

Do not install the water heater in a confined space unless an adequate supply of air for combustion and ventilation is brought in to that space using the methods described in the Confined Space section that follows.

Never obstruct the flow of ventilation air. If you have any doubts or questions at all, call your gas supplier. Failure to provide the proper amount of combustion air can result in a fire or explosion and cause property damage, serious bodily injury or death.

UNCONFINED SPACE

An unconfined space is one whose volume is not less than 50 cubic feet per 1,000 Btu/hr (4.8 cubic meters per kW) of the total input rating of all appliances installed in the space. Rooms communicating directly with the space, in which the appliances are installed, through openings not furnished with doors, are considered a part of the unconfined space.

Makeup air requirements for the operation of exhaust fans, kitchen ventilation systems, clothes dryers and fireplaces shall also be considered in determining the adequacy of a space to provide combustion, ventilation and dilution air.

UNUSUALLY TIGHT CONSTRUCTION

In unconfined spaces in buildings, infiltration may be adequate to provide air for combustion, ventilation and dilution of flue gases. However, in buildings of unusually tight construction (for example, weather stripping, heavily insulated, caulked, vapor barrier, etc.) additional air must be provided using the methods described in the Confined Space section that follows.

CONFINED SPACE

A confined space is one whose volume is less than 50 cubic feet per 1,000 Btu/hr (4.8 cubic meters per kW) of the total input rating of all appliances installed in the space.

Openings must be installed to provide fresh air for combustion, ventilation and dilution in confined spaces. The required size for the openings is dependent on the method used to provide fresh air to the confined space and the total Btu/hr input rating of all appliances installed in the space.

DIRECT VENT WATER HEATERS

Water heaters installed in a direct vent configuration that derive all air for combustion from the outdoor atmosphere through sealed intake air piping are not factored in the total water heater input Btu/hr calculations used to determine the size of openings providing fresh air into confined spaces.

EXHAUST FANS

Where exhaust fans are installed, additional air shall be provided to replace the exhausted air. When an exhaust fan is installed in the same space with a water heater, sufficient openings to provide fresh air must be provided that accommodate the requirements for all appliances in the room and the exhaust fan. Undersized openings will cause air to be drawn into the room through the water heater's vent system causing poor combustion. Sooting, serious damage to the water heater and the risk of fire or explosion may result. It can also create a risk of asphyxiation.

LOUVERS AND GRILLES

The free areas of the fresh air openings in the instructions that follow do not take in to account the presence of louvers, grilles or screens in the openings.

The required size of openings for combustion, ventilation and dilution air shall be based on the "net free area" of each opening. Where the free area through a design of louver or grille or screen is known, it shall be used in calculating the size of opening required to provide the free area specified. Where the louver and grille design and free area are not known, it shall be assumed that wood louvers will have 25% free area and metal louvers and grilles will have 75% free area. Non motorized louvers and grilles shall be fixed in the open position.

FRESH AIR OPENINGS FOR CONFINED SPACES

The following instructions shall be used to calculate the size, number and placement of openings providing fresh air for combustion, ventilation and dilution in confined spaces. The illustrations shown in this section of the manual are a reference for the openings that provide fresh air into confined spaces only. Do not refer to these illustrations for the purpose of vent installation. See Venting section on Page 21 for complete venting installation instructions.

OUTDOOR AIR THROUGH TWO OPENINGS

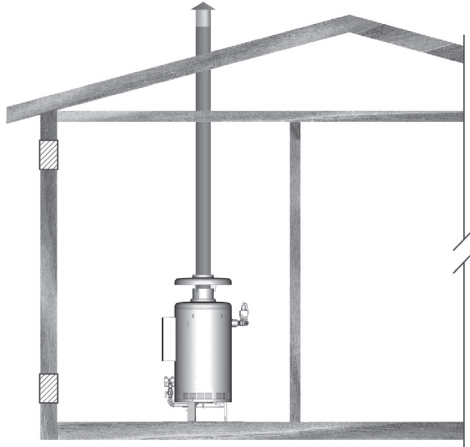

FIGURE 9. OUTDOOR AIR THROUGH TWO OPENINGS

The confined space shall be provided with two permanent openings, one commencing within 12 inches (300 mm) of the top and one commencing within 12 inches (300 mm) of the bottom of the enclosure. The openings shall communicate directly with the outdoors. See Figure 9.

Each opening shall have a minimum free area of 1 square inch per 4,000 Btu/hr (550 mm² per kW) of the aggregate input rating of all appliances installed in the enclosure. Each opening shall not be less than 100 square inches (645 cm²).

OUTDOOR AIR THROUGH ONE OPENING

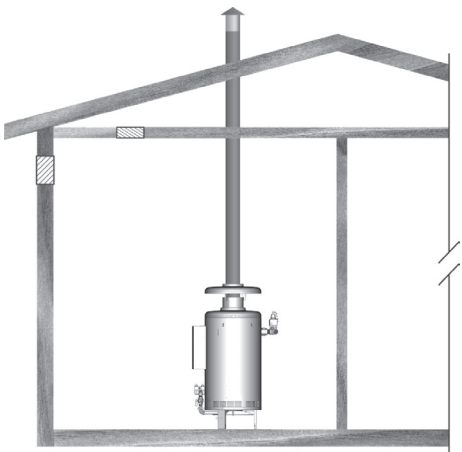

FIGURE 10. OUTDOOR AIR THROUGH ONE OPENING

Alternatively a single permanent opening, commencing within 12 inches (300 mm) of the top of the enclosure, shall be provided. See Figure 10. The water heater shall have clearances of at least 1 inch (25 mm) from the sides and back and 6 inches (150 mm) from the front of the appliance. The opening shall directly communicate with the outdoors or shall communicate through a vertical or horizontal duct to the outdoors or spaces that freely

communicate with the outdoors and shall have a minimum free area of the following:

1. 1 square inch per 3000 Btu/hr (733 mm² per kW) of the total input rating of all appliances located in the enclosure, and
2. Not less than the sum of the areas of all vent connectors in the space.

OUTDOOR AIR THROUGH TWO HORIZONTAL DUCTS

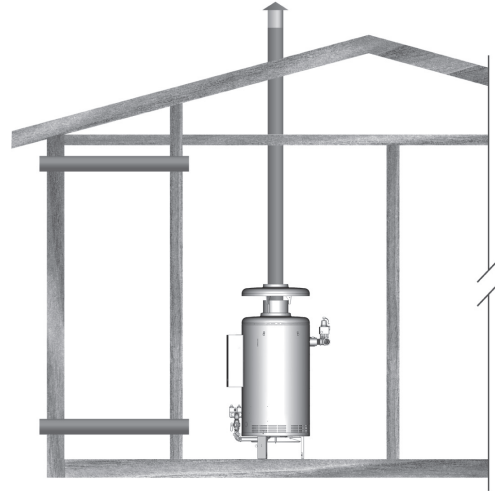

FIGURE 11. OUTDOOR AIR THROUGH TWO HORIZONTAL DUCTS

The confined space shall be provided with two permanent horizontal ducts, one commencing within 12 inches (300 mm) of the top and one commencing within 12 inches (300 mm) of the bottom of the enclosure. The horizontal ducts shall communicate directly with the outdoors. See Figure 11.

Each duct opening shall have a minimum free area of 1 square inch per 2,000 Btu/hr (1100 mm² per kW) of the aggregate input rating of all appliances installed in the enclosure.

When ducts are used, they shall be of the same cross sectional area as the free area of the openings to which they connect. The minimum dimension of rectangular air ducts shall be not less than 3 inches (7.6 cm).

OUTDOOR AIR THROUGH TWO VERTICAL DUCTS

The illustrations shown in this section of the manual are a reference for the openings that provide fresh air into confined spaces only.

Do not refer to these illustrations for the purpose of vent installation.

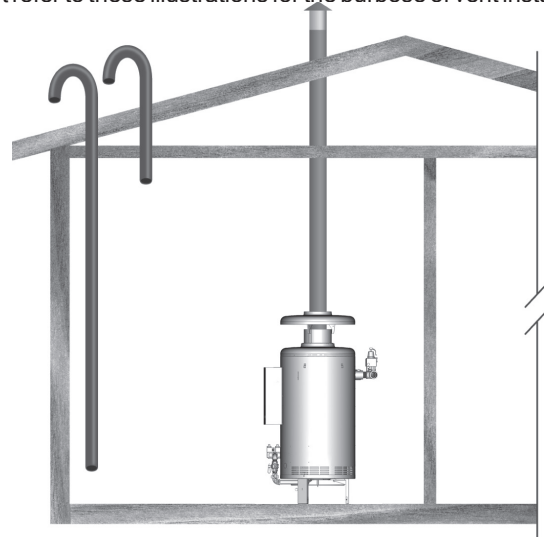

FIGURE 12. OUTDOOR AIR THROUGH TWO VERTICAL DUCTS

The confined space shall be provided with two permanent vertical ducts, one commencing within 12 inches (300 mm) of the top and one commencing within 12 inches (300 mm) of the bottom of the enclosure. The vertical ducts shall communicate directly with the outdoors. See Figure 12.

Each duct opening shall have a minimum free area of 1 square inch per 4,000 Btu/hr (550 mm² per kW) of the aggregate input rating of all appliances installed in the enclosure.

When ducts are used, they shall be of the same cross sectional area as the free area of the openings to which they connect. The minimum dimension of rectangular air ducts shall be not less than 3 inches (7.6 cm).

AIR FROM OTHER INDOOR SPACES

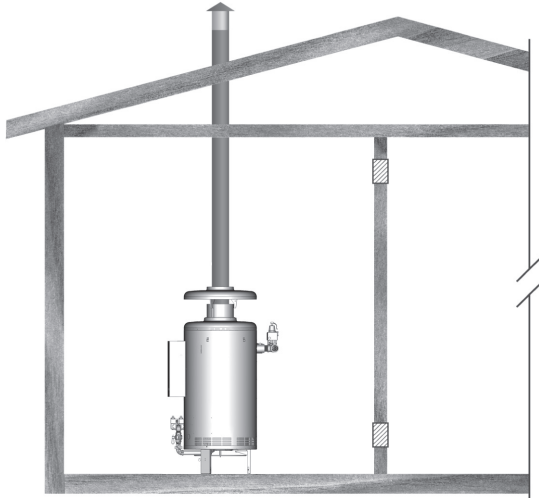

FIGURE 13. AIR FROM OTHER INDOOR SPACES

The confined space shall be provided with two permanent openings, one commencing within 12 inches (300 mm) of the top and one commencing within 12 inches (300 mm) of the bottom of the enclosure. See Figure 13.

Each opening shall communicate directly with an additional room(s) of sufficient volume so that the combined volume of all spaces meets the criteria for an Unconfined Space.

Each opening shall have a minimum free area of 1 square inch per 1,000 Btu/hr (2200 mm² per kW) of the aggregate input rating

of all appliances installed in the enclosure. Each opening shall not be less than 100 square inches (645 cm²).

GAS CONNECTIONS

⚠ CAUTION

Gas Supply

- The gas type must match the gas type on the rating plate.
- Gas supply pressure must match pressure indicated on the rating plate
- Isolate water heater from gas supply piping system.
- Disconnect water heater and main manual gas shutoff valve from gas supply during pressure testing of gas supply system

Make sure the gas on which the water heater is to operate is same as that specified on the rating plate. Do not install water heater if it is equipped for a different type of gas. Consult your gas supplier.

This water heater is not intended to operate at gas supply pressure other than shown on the rating plate. Exposure to higher gas supply pressure may cause damage to gas control valves which can result in fire or explosion. If overpressure has occurred such as through improper testing of gas lines or emergency malfunction of supply system, the gas control valves must be checked for safe operation. Make sure that the outside vents on supply regulators and the safety vent valves are protected against blockage. These are parts of the gas supply system, not the water heater. Vent blockage may occur during ice build-up or snowstorms.

The water heater must be isolated from the gas supply piping system by closing its main manual gas shut off valve during any pressure testing of the gas supply piping system at test pressures equal to or less than 1/2 psig (3.5 kPa).

Disconnect the water heater and its main manual gas shut-off valve from the gas supply piping during any pressure testing of the gas supply system over 1/2 psig (3.5 kPa). The gas supply line must be capped when not connected to the water heater.

It is important to guard against gas control valve fouling from contaminants in the gas ways. Such fouling may cause improper operation, fire or explosion. If copper supply lines are used they must be approved for gas service.

When local codes require a main manual shut-off valve outside the water heater jacket, a suitable main manual shut-off valve must be installed in a location complying with those codes.

Before attaching gas line be sure that all gas pipe is clean on inside. To trap any dirt or foreign material in the gas supply line, a sediment trap must be incorporated in piping. The sediment trap must be readily accessible and not subject to freezing conditions. Install in accordance with recommendations of serving gas supplier. Refer to the current edition of the National Fuel Gas Code, ANSI Z223.1/NFPA 54 or the Natural Gas and Propane Installation Code, CAN/CSA B149.1

Size of gas supply piping may be larger than the water heater gas connection on installations where a significant run of piping is required.

To prevent damage, care must be taken not to apply too much torque when attaching gas supply pipe to the water heater gas inlet. When installing and tightening gas piping use a second wrench to hold the gas control valve to keep the valve from turning. To prevent damage to the gas control valve do not use pipe wrench on the valve body.

Fittings and unions in gas line must be of metal to metal type.

Apply joint compounds (pipe dope) sparingly and only to the male threads of pipe joints. Do not apply compound to the first

two threads. Use compounds resistant to the action of liquefied petroleum gases. The water heater and its gas connection must be leak tested before placing the water heater in operation.

SIZING GAS SUPPLY LINE

Use Table 8., the National Fuel Gas Code, ANSI Z223.1/NFPA 54, or CAN/CSA B149.1 (current edition) to size iron pipe or equivalent gas supply line. Table 8. is based on a pressure drop of 0.3" W.C. from the gas meter to the gas connection of the water heater. A heating value of 1050 btu/cu.ft. and a specific gravity of 0.60 is assumed for natural gas. A heating value of 2500 btu/cu.ft. and a specific gravity of 1.53 is assumed for propane (LP) gas. If the gas service pressure is less than 4.5"W.C. (1.12kPa) for natural gas or 11"W.C. (2.74 kPa) for LP gas, use a pipe size larger than specified in Table 8 to minimize pressure drop in the gas line.



TABLE 8.

Distance to Heater from Meter ft.	Gas Supply Pipe Sizes (in inches)						
	Natural Gas (1050 Btu/ft ³)				Propane Gas (2500 Btu/ft ³)		
	HWH-120	HWH-160	HWH-200	HWH-225	HWH-120	HWH-160	HWH-200
10 (3m)	1/2	3/4	3/4	3/4	1/2	1/2	1/2
30 (9.1m)	3/4	3/4	1	1	1/2	3/4	3/4
50 (15.2m)	3/4	1	1	1	3/4	3/4	1
80 (24.4m)	1	1	1 1/4	1 1/4	3/4	1	1
100 (30.5m)	1	1 1/4	1 1/4	1 1/4	3/4	1	1
150 (45.7m)	1	1 1/4	1 1/4	1 1/4	1	1	1 1/4
200 (61m)	1 1/4	1 1/4	1 1/4	1 1/2	1	1 1/4	1 1/4

Where it is necessary to use more than the average number of pipe fittings i.e. elbows, tees, and valves in gas supply line, use a pipe larger than specified to compensate for increased pressure drop.

VENTING

STANDARD VENTING

! WARNING		
Fire and Breathing Hazard		
	The instructions in this section on venting the water heater must be followed to avoid choked combustion or recirculation of the gases. Such conditions cause sooting or risks of fire and asphyxiation.	

Type B venting may be used with these water heaters. All local utility regulations on venting should be followed.

Vent sizing, installation and termination shall be in accordance with the current edition of the National Fuel Gas Code, ANSI Z223.1, or CAN/CSA B149.1, Installation Codes, or applicable provisions of the local building codes.

Vent connectors serving appliances vented by natural draft shall not be connected into any portion of mechanical draft systems operating under positive pressure.

The minimum distance from adjacent public walkways, adjacent buildings, openable windows and building openings shall not be less than those values specified in the National Fuel Gas Code, ANSI Z223.1 or CAN/CSA B149.1, Installation Codes;

DRAFT HOOD

The draft hood furnished with this water heater must be installed without alteration. Provision must be made if the water heater is installed in confined space or a small mechanical room to accommodate draft hood spillage and avoid risks described above. The upper air opening called for in the AIR REQUIREMENTS section of this manual is for this purpose.

VENT CONNECTION

Size and install proper size vent pipe. Do not reduce pipe size to less than that of the draft hood outlet.

Horizontal runs of vent pipe shall be securely supported by adequately placed (approximately every 4 feet or 1 meter), noncombustible hangers and/or slip joints suitable for the weight and design of the materials employed to prevent sagging and to maintain a minimum upward slope of 1/4" (21 mm/m) per foot from the water heater to the vent terminals, see Figure 14. Dampers or other obstructions must not be installed in the vent. Be sure that the vent pipe does not extend beyond the inside wall of the chimney.

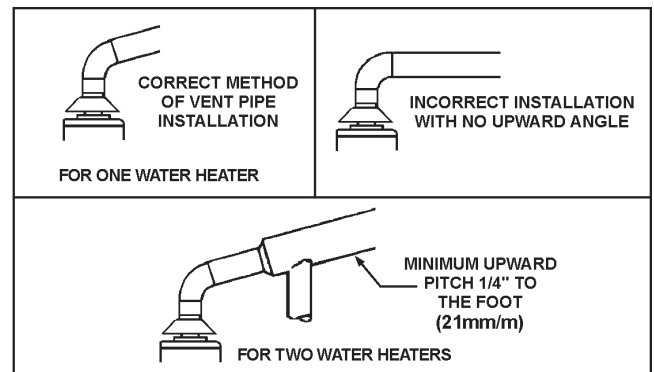

FIGURE 14. VENT PIPE INSTALLATION

Where a continuous or intermittent back draft is found to exist the cause must be determined and corrected. A special vent cap may be required. If the back draft cannot be corrected by the normal methods or if a suitable draft cannot be obtained, a blower type flue gas exhauster may be employed to ensure proper venting and correct combustion if permitted by local codes.

Vent connectors serving appliances vented by natural draft shall not be connected into any portion of mechanical draft systems operating under positive pressure.

CONNECTING WATER HEATER TO A COMMON VENT

Do not connect the water heater to a common vent or chimney with solid fuel burning equipment. This practice is prohibited by many local building codes as is the practice of venting gas fired equipment to the duct work of ventilation systems.

Where a separate vent connection is not available and the vent pipe from the water heater must be connected to a common vent with oil burning equipment, the vent pipe should enter the common vent or chimney at a point ABOVE the flue pipe from the oil fired unit.

Where two or more appliances vent into a common vent connector or manifold, the area of the common vent or vent connector should at least equal the area of the largest vent connector plus 50% of the areas of the additional draft hood outlets.

When removing a water heater from a system with a common vent, use the following steps:

Be sure the other appliances connected to the common vent are not in operation.

Seal any unused openings in the common venting system.

Visually inspect the venting system for proper size and horizontal pitch and determine there is no blockage or restriction, leakage, corrosion and other deficiencies which could cause an unsafe condition.

Insofar as is practical, close all building doors and windows and all doors between the space in which the appliances remaining connected to the common venting system are located and other spaces of the building. Turn on clothes dryers and any appliance not connected to the common venting system. Turn on any exhaust fans, such as range hoods and bathroom exhausts, so they will operate at maximum speed. Close fireplace dampers.

Place in operation the appliance being inspected. Follow the operating instructions. Adjust thermostat so appliance will operate continuously.

Test for spillage at the draft hood relief opening after five minutes of main burner operation. Use the flame of a match or candle.

After it has been determined that each appliance remaining connected to the common venting system properly vents when tested as outlined above, return doors, windows, exhaust fans, fireplace dampers and any other gas burning appliance to their previous conditions of use.

Any improper operation of the common venting system should be corrected so the installation conforms with the current edition of National Fuel Gas Code, ANSI Z223.1 or CAN/CSA B149.1. When resizing any portion of the common venting system, the common venting system should be resized to approach the minimum size as determined using the appropriate tables in the National Fuel Gas Code, ANSI Z223.1 or CAN/CSA B149.1.

MULTIPLE VENT TABLE

Table 9 on Page 21 has been compiled to show the material sizes in a Type B doublewall combined vent system including the vent connector. Refer to the current edition of NFPA 54 or CAN/CSA B149.1 for further information.

A combined vent system is one in which two or more water heaters at one level are attached to a common vent.

In order to use Table 9, the connector rise and total vent height must be known. Connector rise is vertical distance from the draft hood outlet to the point where the manifold connection is made. Total vent height is the least vertical distance from a draft hood outlet to the top of the vent. Local codes or utility requirements often govern termination height. ULC listed doublewall gas vents, up through 24" (610 mm) diameter, can be installed in heated and unheated areas and can pass through floors, ceilings, partitions, walls and roofs, provided the required one inch clearance is observed. These vents should be installed in accordance with National Fuel Gas Code, ANSI Z223.1 or CAN/CSA B149.1.

EXAMPLE SHOWING USE OF THE HWH-225 COMBINED VENT SIZING TABLE

NOTE: MANIFOLD MAY BE SLOPED UPWARD BUT ALL WATER HEATERS MUST HAVE REQUIRED (ONE FOOT) MINIMUM CONNECTOR RISE.

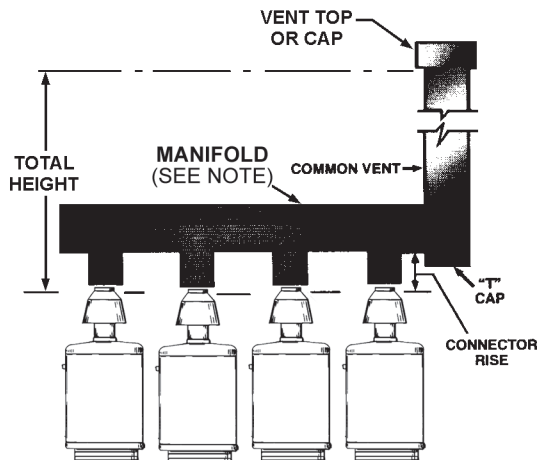

NOTE: MANIFOLD LENGTH FROM THE BASE OF THE VERTICAL VENT TO THE NEAREST APPLIANCE SHOULD NOT EXCEED 10 FEET OR 50% OF THE TOTAL VENT HEIGHT, WHICHEVER IS GREATEST.

FIGURE 15. EXAMPLE FOR COMBINED VENT SIZING TABLE

VENTING SYSTEM

Have venting system checked every six months for obstructions and/or deterioration in vent piping. Refer to Venting Maintenance on Page 38.

1. Insofar as is practical, close all doors, windows and air inlets to the building. Turn on all exhaust fans (range hood, bathroom exhaust, etc.) so they will operate at their maximum speed. Close fireplace dampers.
2. After allowing the water heater to operate for five minutes, test for spillage at the draft hood relief opening.
3. Operate vent connected gas utilization equipment for several minutes and check to see that the combustion products are going up the chimney or gas vent properly by passing a lighted match or taper around the edge of the relief opening of the draft hood. If the chimney or gas vent is drawing properly, the match flame will be drawn into the draft hood. If not, the combustion products will tend to extinguish this flame. See Figure 16.

If the combustion products are escaping from the relief opening of the draft hood, do not operate the equipment until proper adjustment or repairs are made to provide adequate draft through the chimney or gas vent.

4. Next, turn on all other fuel burning appliances within the same room so they will operate at their full input.

Repeat step 3 above, checking the draft on each appliance.

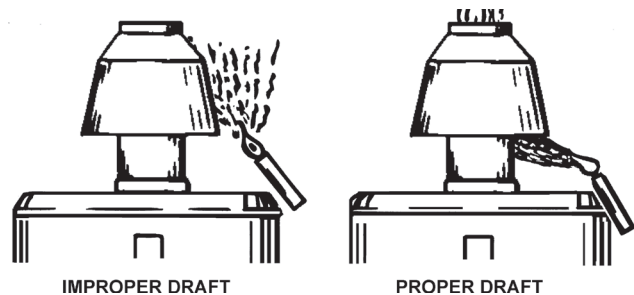

FIGURE 16. VENTING SYSTEM

TABLE 9. COMBINED VENT SIZING TABLES

Model HWH-120			Total Vent Height (Feet)							
Input: 120,000 btu/hr			6	8	10	15	20	30	50	100
Draft hood outlet diameter: 6 inches			Vent Connector Diameter (Inches)							
	Input (btu/hr)	Rise								
	120,000	1 Ft.	7	7	7	6	6	6	6	6
	120,000	2 Ft.	6	6	6	6	6	6	6	6
	120,000	3 Ft.	6	6	6	6	6	6	6	6
Number of Heaters	Combined Input (btu/hr)	Manifold and Common Vent Diameter (Inches)								
2	240,000	9	8	8	7	7	7	6	-	
3	360,000	10	10	9	9	8	8	7	7	
4	480,000	12	12	12	10	10	9	8	8	

Model HWH-160			Total Vent Height (Feet)							
Input: 160,000 btu/hr			6	8	10	15	20	30	50	100
Draft hood outlet diameter: 7 inches			Vent Connector Diameter (Inches)							
	Input (btu/hr)	Rise								
	160,000	1 Ft.	8	8	8	7	7	7	7	7
	160,000	2 Ft.	7	7	7	7	7	7	7	7
	160,000	3 Ft.	7	7	7	7	7	7	7	7
Number of Heaters	Combined Input (btu/hr)	Manifold and Common Vent Diameter (Inches)								
2	320,000	10	9	9	8	8	7	7	7	
3	480,000	12	12	12	10	10	9	8	8	
4	640,000	14	14	12	12	12	10	10	9	

Model HWH-200			Total Vent Height (Feet)							
Input: 199,000 btu/hr			6	8	10	15	20	30	50	100
Draft hood outlet diameter: 7 inches			Vent Connector Diameter (Inches)							
	Input (btu/hr)	Rise								
	199,000	1 Ft.	9	9	8	8	8	8	8	7
	199,000	2 Ft.	8	8	8	8	7	7	7	7
	199,000	3 Ft.	8	8	7	7	7	7	7	7
Number of Heaters	Combined Input (btu/hr)	Manifold and Common Vent Diameter (Inches)								
2	398,000	10	10	9	9	8	8	7	7	
3	597,000	14	14	12	12	12	10	9	9	
4	796,000	16	14	14	14	12	12	12	10	

Model HWH-225			Total Vent Height (Feet)							
Input: 225,000 btu/hr			6	8	10	15	20	30	50	100
Draft hood outlet diameter: 7 inches			Vent Connector Diameter (Inches)							
	Input (btu/hr)	Rise								
	225,000	1 Ft.	9	9	9	9	9	8	8	8
	225,000	2 Ft.	9	8	8	8	8	8	7	7
	225,000	3 Ft.	8	8	8	8	7	7	7	7
Number of Heaters	Combined Input (btu/hr)	Manifold and Common Vent Diameter (Inches)								
2	450,000	12	12	12	10	9	9	8	8	
3	675,000	14	14	14	12	12	12	10	9	
4	900,000	16	16	16	14	14	12	12	12	

Example: Known: (4) model HWH-225 water heaters. (See illustration). Connector rise - 2' (Note 1' is minimum). Total vent height 30'.

Problem: Determine diameter of connector, manifold and common vent.

Procedure: Enter the top of the HWH-225 table (total vent height) at 30' and the side at 2' (connector rise). An 8" connector diameter is indicated for each connector rise.

To determine the manifold and common vent size, enter table on this page (total vent height) at 30 and the side at 4 water heaters. A manifold diameter of 12" (30 cm) is indicated.

GAS SUPPLY CONNECTIONS

GAS SUPPLY PIPE CONNECTIONS

1. Make sure to install ground joint union for servicing.
2. In Canada: When using the manual main shutoff valve to support the weight of the piping, ensure that it is identified by the installer.
3. Install sediment trap per NFPA 54 for US and CAN B149.1 for Canada.
4. Support the piping with hangers, not by the water heater or its accessories. The gas control valve will not support the weight of the piping. Failure to comply could result in severe personal injury, death, or substantial property damage.
5. Purge all air from the gas supply piping.
6. Before setting the water heater in operation, check the water heater and its gas connection for leaks.
 - Disconnect the water heater from the gas supply piping system during any pressure testing, at a test pressure in excess of 1/2 PSIG (3.5 kPa)
 - The water heater must be isolated from the gas supply piping system by closing a manual shutoff valve during any pressure testing, at test pressures equal to or less than 1/2 PSIG (3.5 kPa).

Do not check for gas leaks with an open flame, instead use the bubble test. Failure to use the bubble test or check for gas leaks can cause severe personal injury, death, or substantial property damage.

7. Use pipe sealing compound compatible with propane gases. Apply sparingly only to male threads of the pipe joints so that pipe sealing compound does not block gas flow.

Failure to apply pipe sealing compound as detailed in this manual can result in severe personal injury, death, or substantial property damage.

8. Make sure the maximum inlet gas pressure does not exceed the value specified. Minimum value specified is for input adjustment only.

Make sure to use two wrenches when tightening gas piping at the water heater, using one wrench to prevent the water heater gas line connection from turning. Failure to support the water heater gas connection pipe to prevent it from turning could damage gas line components. Do not use wrench on valve body as damage would occur.

GAS PRESSURE REQUIREMENTS

Refer to Table 4 for gas pressure requirements. Install a positive lock-up gas pressure regulator in the gas supply line if inlet gas pressure can exceed 13" W.C. (3.2 kPa) for Natural gas and 13.5" W.C. (3.4 kPa) for Propane gas.

If a positive lock-up regulator is required follow these instructions:

1. Positive lock-up gas pressure regulators must be rated at or above the input Btu/hr rating of the water heater they supply.
2. Positive lock-up gas pressure regulator(s) should be installed no closer than 3 equivalent feet (1 meter) and no farther than 8 equivalent feet (2.4 meters) from the water heater's inlet gas connection.

3. After installing the positive lock-up gas pressure regulator(s), an initial nominal supply pressure setting of 7 inches w.c. (1.7 kPa) for Natural Gas or 12" W.C. (3.0 kPa) for Propane while the water heater is operating is recommended and will generally provide good water heater operation. Some additional adjustment maybe required later to maintain a steady gas supply pressure.
4. When installing multiple water heaters in the same gas supply system it is recommended that individual positive lock-up gas pressure regulators be installed at each unit.

PIPE SIZES FOR PROPANE GAS

Make sure to contact the gas supplier for pipe sizes, tanks, and 100% lockup gas pressure regulator.

PURGING GAS LINE

Gas line purging is required with new piping or systems in which air has entered. Gas purging should be performed per NFPA 54 for US and CAN B149.1 for Canada.

CHECK GAS SUPPLY INLET PRESSURE

CSA or UL listed flexible gas connections are acceptable, but make sure that the line has adequate capacity to allow your water heater to fire at full rate. Consult with local codes for proper installation or service procedures.

Make sure the gas piping is sized for the proper flow and length of pipe to avoid excessive pressure drop. The gas meter and the gas regulator must be properly sized for the total gas load.

Perform the below steps when checking inlet gas supply:

1. Turn the main power switch to the "OFF" position.
2. Shut off gas supply.
3. Remove the 1/8" pipe plug from the inlet pressure tap on the gas control valve and install a suitable 1/8" hose barb fitting (field supplied) for the manometer tubing. See Figure 17 for the location of the inlet pressure tap on the gas control valve. Connect the manometer tube to the hose barb fitting.
4. Slowly turn on the gas supply.
5. Ensure inlet pressure is within specified range.
6. If the gas pressure is out of range, contact the gas utility, gas supplier, qualified installer or service agency to determine the necessary steps to provide proper gas pressure to the control.

CHECK FOR GAS LEAKS

Before operating the water heater, make sure to check the floor near and around the water heater for gas odorant or any unusual odor. Remove the combustion chamber access panel and check for odor in the interior of the water heater enclosure. Do not start the water heater if there is any indication of a gas leak. Use an approved leak detection solution and repair any leaks at once.

In the case of propane water heaters, the supplier mixes an odorant with the propane to make its presence detectable. But in some instances, the odorant can fade, and the gas may no longer have an odor. Before operating the water heater, make sure the propane supplier verifies the correct odorant level in the gas. Gas Manifold Pressure Regulators

GAS MANIFOLD PRESSURE

The gas manifold pressure regulator is included in the combination gas control valve, Figure 17, and is set to operate on the gas specified on the water heater model and rating plate.

Refer to Table 4 for the correct manifold gas pressure set point.

Adjustment, if required, is performed as follows:

1. Set primary system temperature control dial (thermostat) at lowest setting so that water heater will not call for heat.
2. Attach a pressure gauge to the manifold pressure tap.
3. Reset primary system temperature control dial (thermostat) to highest setting. Main burner will now ignite.
4. With main burner firing, adjust pressure, if necessary, by turning pressure regulator adjusting screw with a screwdriver.

- Clockwise to increase pressure.
- Counterclockwise to decrease pressure.

5. Set primary system temperature control dial (thermostat) to lowest setting to turn off main burner.
6. Remove pressure gauge and replace the manifold pressure tap sealing plug.
7. Set primary system temperature control dial (thermostat) to desired setting.

Do not increase the manifold gas pressure above that specified on the rating plate, as overfiring will result in damage to the water heater, as well as increased risk of fire, sooting and asphyxiation.

If gas pressure regulator cannot be adjusted to the correct manifold gas pressure with sufficient gas pressure at the valve, replace with new gas control valve.

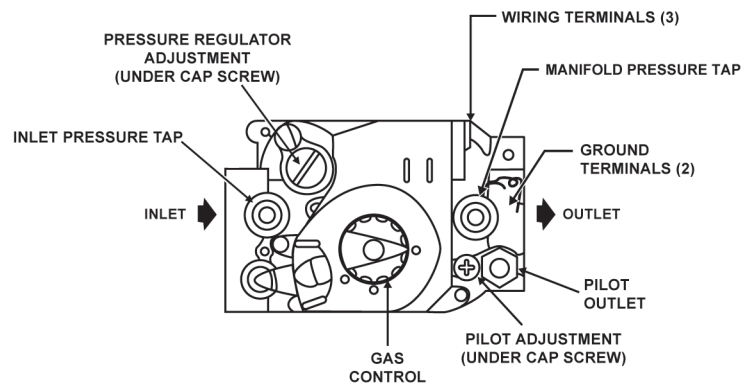

FIGURE 17. GAS CONTROL VALVE (NATURAL GAS & PROPANE)

WATER HEATER START UP AND OPERATIONS

Before operating the water heater, the entire system must be filled with water, purged of air and checked for leaks. The gas piping should also be leak tested. All leaks must be repaired before operating the water heater.

After placing the water heater into operation, the ignition system safety shutoff device must be tested by the following test method.

1. Set the Tank Temperature Control to maximum setting, causing a call for heat and allowing unit to run until the Automatic Reset Limit Control trips.
2. Draw hot water from the tank until the Tank Temperature Control calls for heat. The unit should run again until the Automatic Reset Limit Control trips. If the unit fails to run, see Troubleshooting in this manual.
3. Reset the Tank Temperature Control to desired temperature.

Any safety devices used in conjunction with this water heater should receive periodic (every six months) inspection to assure proper operation. All pressure relief valves should be inspected and manually operated at least twice a year.

IMPORTANT

It is recommended that a qualified service agency perform the initial firing of the water heater. At this time the user should not hesitate to ask the individual any questions which he may have in regard to the operation and maintenance of the unit.

PRECAUTIONS

If the unit is exposed to the following, do not operate water heater until all corrective steps have been made by a qualified service agency:

- Flooding to level of burner or controls or higher.
- Exposure to fire.
- If damaged.
- Firing without water.
- Sooting.

CAUTION

Gas Supply

Should overheating occur or the gas supply fail to shut off, turn off the manual gas control valve to the appliance.

CHECKING AND ADJUSTING INPUT

	<h1>! WARNING</h1>
	<h3>Fire and Explosion Hazard</h3>
	<ul style="list-style-type: none"> Under no circumstances should the input exceed the rate shown on the water heater's rating label. Overfiring could result in fire or explosion. Gas and carbon monoxide detectors are available.

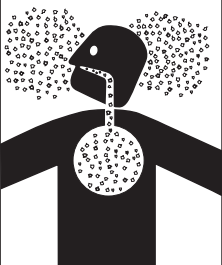
<h1>! WARNING</h1>	
<h3>Breathing Hazard - Carbon Monoxide Gas</h3>	
	<ul style="list-style-type: none"> Under no circumstances should the input exceed the rate shown on the water heater's rating label. Overfiring could result in damage to the water heater and sooting. Gas and carbon monoxide detectors are available.
	<p>Breathing carbon monoxide can cause brain damage or death. Always read and understand instruction manual.</p>

- Follow steps 1 thru 6 of the Operating Instructions on Page 27.
- Attach a pressure gauge or a manometer to the manifold pressure tap.
- Follow steps 7 thru 11 of the Operating Instructions on page 27.
- Use this formula to "clock" the gas meter. Be sure that other gas consuming appliances are not ON during this interval.

$$\frac{3600}{T} \times H = \text{Btuh}$$

Btuh = The approximate actual input rate.
 T = Time in seconds to burn one cubic foot of gas.
 H = Heating value of the fuel gas in Btu per cubic foot of gas.

EXAMPLE:

T = 31.5 seconds
 H = 1050 Btu/ft³(natural gas)
 Btuh = ?

Gas flow through meter:

$$\frac{3600}{31.5} \times 1050 = 120,000 \text{ Btuh}$$

Small changes in the input rate may be made by adjusting the manifold pressure. Refer to Figure 17 for the location of the pressure regulator adjustment on the gas valve. Also refer to Table 4 for nominal manifold pressure. Under no circumstances should you exceed the maximum input rate for the water heater given in Table 2 on Page 6. When the manifold pressure has been adjusted to yield the correct input rate, proceed to step 5.

- Shut off the water heater by following steps 1 thru 6 of the Operating Instructions on page 27.
- Remove the pressure gauge or manometer from the manifold pressure tapping. Replace the screw-in plug in the manifold pressure tap.
- Repeat steps 7 thru 11 of the Operating Instructions on page 27. The water heater will resume normal operation.

When the water heater is operating at full capacity, or full gas input, it should consume 1 cu. ft. of gas in approximately the time indicated in Table 10.

TABLE 10. CONSUMPTION RATE (REFER TO OPERATING AT FULL INPUT OR FULL CAPACITY)

TYPE GAS	HEATING VALUE BTU/FT.	TIME TO CONSUME 1 CU. FT. OF GAS (SECONDS)			
		HWH-120	HWH-160	HWH-200	HWH-225
Natural	1050	31.5	23.6	19.0	16.8
Propane	2500	75	56.3	45.2	

The inlet gas pressure must not exceed or be less than the values shown on rating plate.

SEQUENCE OF OPERATION FLOWCHART

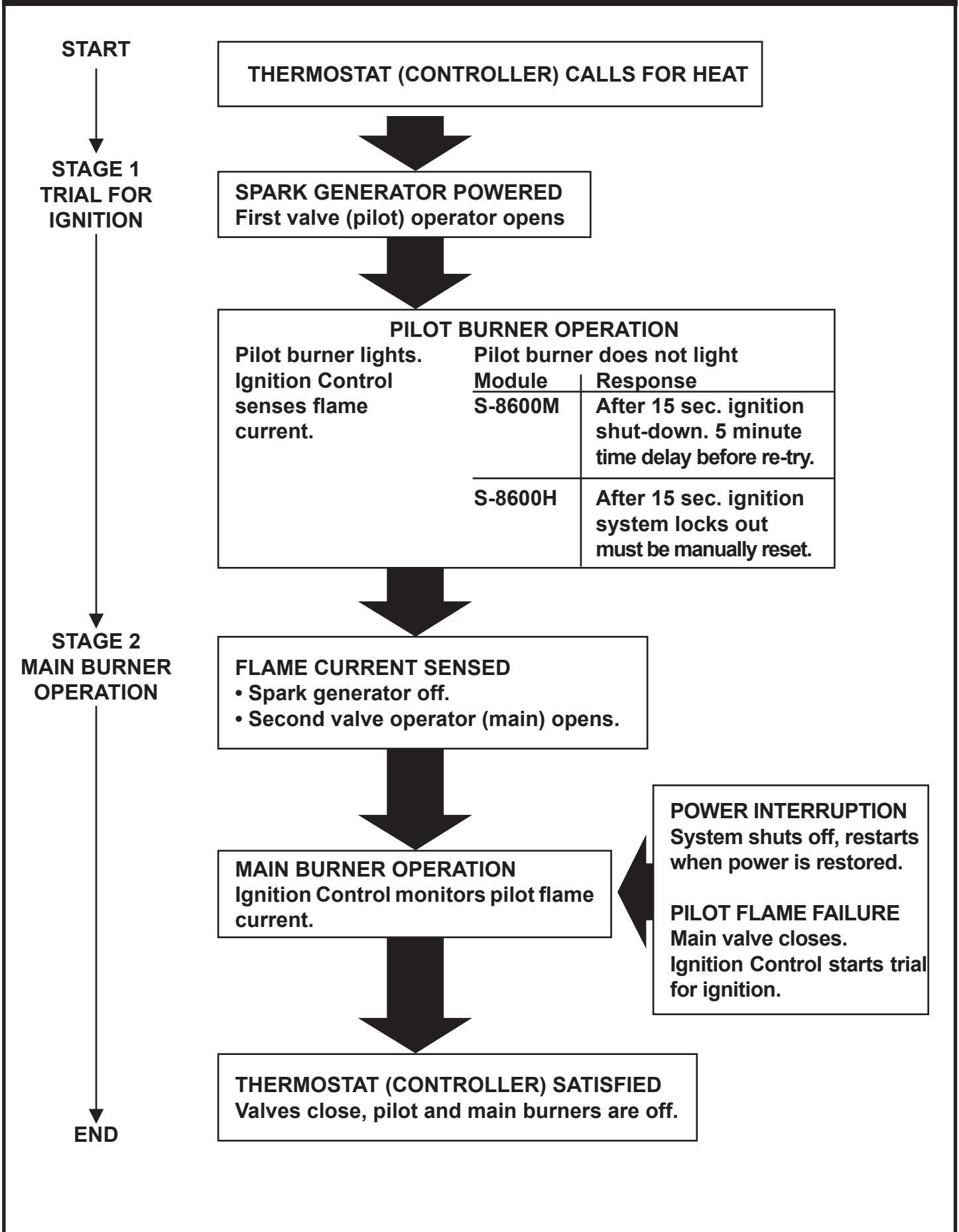

OPERATING INSTRUCTIONS
(NATURAL AND PROPANE FOR HWH120 - HWH225)

FOR YOUR SAFETY READ BEFORE OPERATING



WARNING: If you do not follow these instructions exactly, a fire or explosion may result causing property damage, personal injury or loss of life.



WARNING: HOT WATER CAN PRODUCE 3rd DEGREE BURNS IN 6 SECONDS AT 140°F. (60°C). IN CASE OF POWER FAILURE DO NOT ATTEMPT TO OPERATE APPLIANCE. IMPROPER INSTALLATION, ADJUSTMENT, ALTERATION, SERVICE OR MAINTENANCE CAN CAUSE PROPERTY DAMAGE, PERSONAL INJURY OR LOSS OF LIFE. REFER TO THE INSTRUCTION MANUAL PROVIDED WITH THIS APPLIANCE. INSTALLATION AND SERVICE MUST BE PERFORMED BY A QUALIFIED INSTALLER, SERVICE AGENCY OR THE GAS SUPPLIER.

- A. THIS APPLIANCE IS EQUIPPED WITH AN IGNITION DEVICE WHICH AUTOMATICALLY LIGHTS THE PILOT. DO NOT TRY TO LIGHT THE PILOT BY HAND.
- B. BEFORE OPERATING: SMELL ALL AROUND THE APPLIANCE AREA FOR GAS. BE SURE TO SMELL NEXT TO THE FLOOR BECAUSE SOME GAS IS HEAVIER THAN AIR AND WILL SETTLE ON THE FLOOR.

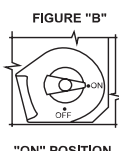
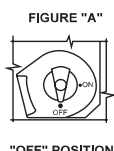
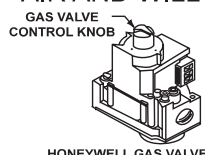

- WHAT TO DO IF YOU SMELL GAS**
- DO NOT TRY TO LIGHT ANY APPLIANCE.
 - DO NOT TOUCH ANY ELECTRIC SWITCH; DO NOT USE ANY PHONE IN YOUR BUILDING.
 - IMMEDIATELY CALL YOUR GAS SUPPLIER FROM A NEIGHBOR'S PHONE. FOLLOW THE GAS SUPPLIER'S INSTRUCTIONS.
 - IF YOU CANNOT REACH YOUR GAS SUPPLIER, CALL THE FIRE DEPARTMENT.
- C. USE ONLY YOUR HAND TO TURN THE GAS CONTROL KNOB. NEVER USE TOOLS. IF THE KNOB WILL NOT TURN BY HAND, DON'T TRY TO REPAIR IT, CALL A QUALIFIED SERVICE TECHNICIAN. FORCE OR ATTEMPTED REPAIR MAY RESULT IN A FIRE OR EXPLOSION.
- D. DO NOT USE THIS APPLIANCE IF ANY PART HAS BEEN UNDER WATER. IMMEDIATELY CALL A QUALIFIED SERVICE TECHNICIAN TO INSPECT THE APPLIANCE AND TO REPLACE ANY PART OF THE CONTROL SYSTEM AND ANY GAS CONTROL WHICH HAS BEEN UNDER WATER.
- E. DO NOT OPERATE APPLIANCE UNLESS UNIT IS FILLED WITH WATER AND INLET LINES ARE FULLY OPEN.

OPERATING INSTRUCTIONS

1. STOP! READ THE SAFETY INFORMATION ABOVE ON THIS LABEL.
2. SET THE THERMOSTAT TO LOWEST SETTING.
3. TURN OFF ALL ELECTRIC POWER TO THE APPLIANCE.
4. DO NOT ATTEMPT TO LIGHT THE PILOT BY HAND
5. REFER TO DIAGRAMS ABOVE. TURN TOP KNOB OF GAS CONTROL (FIG. "A") CLOCKWISE ↻ TO "OFF" POSITION.
6. WAIT FIVE (5) MINUTES TO CLEAR OUT ANY GAS. IF YOU THEN SMELL GAS, STOP! FOLLOW "B" IN THE SAFETY INFORMATION ABOVE ON THIS LABEL. IF YOU DON'T SMELL GAS, GO TO THE NEXT STEP.
7. TURN TOP KNOB OF GAS CONTROL COUNTER-CLOCKWISE ↺ TO "ON" (FIG. "B").
8. TURN ON ALL ELECTRIC POWER TO THE APPLIANCE.
9. SET THERMOSTAT TO DESIRED SETTING.
10. WHEN THERMOSTAT CALLS FOR HEAT, THE CIRCULATING PUMP WILL OPERATE AND THE PILOT BURNER WILL BE SPARK IGNITED. GAS CONTROL WILL OPEN AND MAIN BURNER WILL THEN IGNITE. NOTE: IF PILOT FAILS TO IGNITE, TURN OFF APPLIANCE AND CONSULT YOUR "INSTRUCTION MANUAL" FOR ADJUSTMENTS AND TROUBLE SHOOTING.
11. IF THE APPLIANCE WILL NOT OPERATE, FOLLOW THE INSTRUCTIONS "TO TURN OFF GAS TO APPLIANCE" AND CALL YOUR SERVICE TECHNICIAN OR GAS SUPPLIER.

TO TURN OFF GAS TO APPLIANCE

- A. SET THE THERMOSTAT TO LOWEST SETTING.
- B. TURN OFF ALL ELECTRIC POWER TO APPLIANCE IF SERVICE IS TO BE PERFORMED.
- C. TURN TOP KNOB OF GAS CONTROL VALVE CLOCKWISE ↻ TO "OFF" POSITION (FIG. "A").

TROUBLESHOOTING

Before any extensive troubleshooting, perform the following:

Ensure that:

- Voltage (120 vac) is supplied to the water heater.
- System control (tank temperature control, thermostat, etc.) is calling for water heater operation (call for heat).
- Other contacts (switches) are closed (relay, flow switch, limit controls, pressure switch, etc.).
- Gas supply pressure is within the maximum and minimum operating ranges listed on the water heater rating plate/label.

- Voltage (24 vac) is supplied by transformer.
- Water heater is wired according to wiring diagram.

Note: Cross wiring the 24 volt circuit of the relay will short the transformer.

- All wire terminals/connectors are firmly attached to valves, controls, switches, limit controls, etc.
- For Propane (LP) models check for possible lockout condition of the ignition control.

TABLE 11. CER-TEMP RECOVERY SYSTEM CHECKOUT PROCEDURE

Use this checkout for Cer-Temp Recovery Systems. (For hot water supply application only)

CHECKOUT SEQUENCE	SYSTEM OPERATION		CAUSE	REMEDY
	CORRECT	INCORRECT		
Set tank temperature control (thermostat) 20°F (11°C) below tank water temperature.	Circulating pump and burner shut off.	Pump and burner remain on.	Tank temperature control (thermostat) defective.	Replace.
			System wiring is incorrect.	Correct wiring.
	With thermal balancer, pump off delay of approximately 2 minutes.	Circulating pump on.	Pump wired for continuous operation.	Correct wiring.
			Burner on.	Gas control valve stuck or defective.
		System wiring is incorrect.		Correct wiring.
Set tank temperature control (thermostat) 20°F (11°C) above tank water temperature.	Circulating pump and burner on.	Circulating pump on.	Auto reset limit control calibrated too low.	Replace. (If problem proven to be at this control by applying jumper to terminals.)
			Auto reset limit control differential too wide.	
			System wiring is incorrect.	Correct wiring.
			Manual reset high limit switch has activated.	Remove control cover, depress reset button.
			Gas control valve or wiring defective.	Check wiring. Repair or replace valve.
	Circulating pump and burner off.	Circulating pump and burner off.	Power off or system wiring is incorrect.	Check power supply and wiring.
			Tank temperature control (thermostat) defective.	Replace.
Burner on.	Burner on.	System wiring is incorrect.	Correct wiring.	
Water heater outlet temperature exceeds 210°F (100°C).	Circulating pump on.	Circulating pump and burner on.	Auto reset limit control defective.	Replace.
Set tank temperature control (thermostat) for desired water temperature.	System maintains desired water temperature.			

CHECKING INTERMITTENT IGNITION CONTROLS

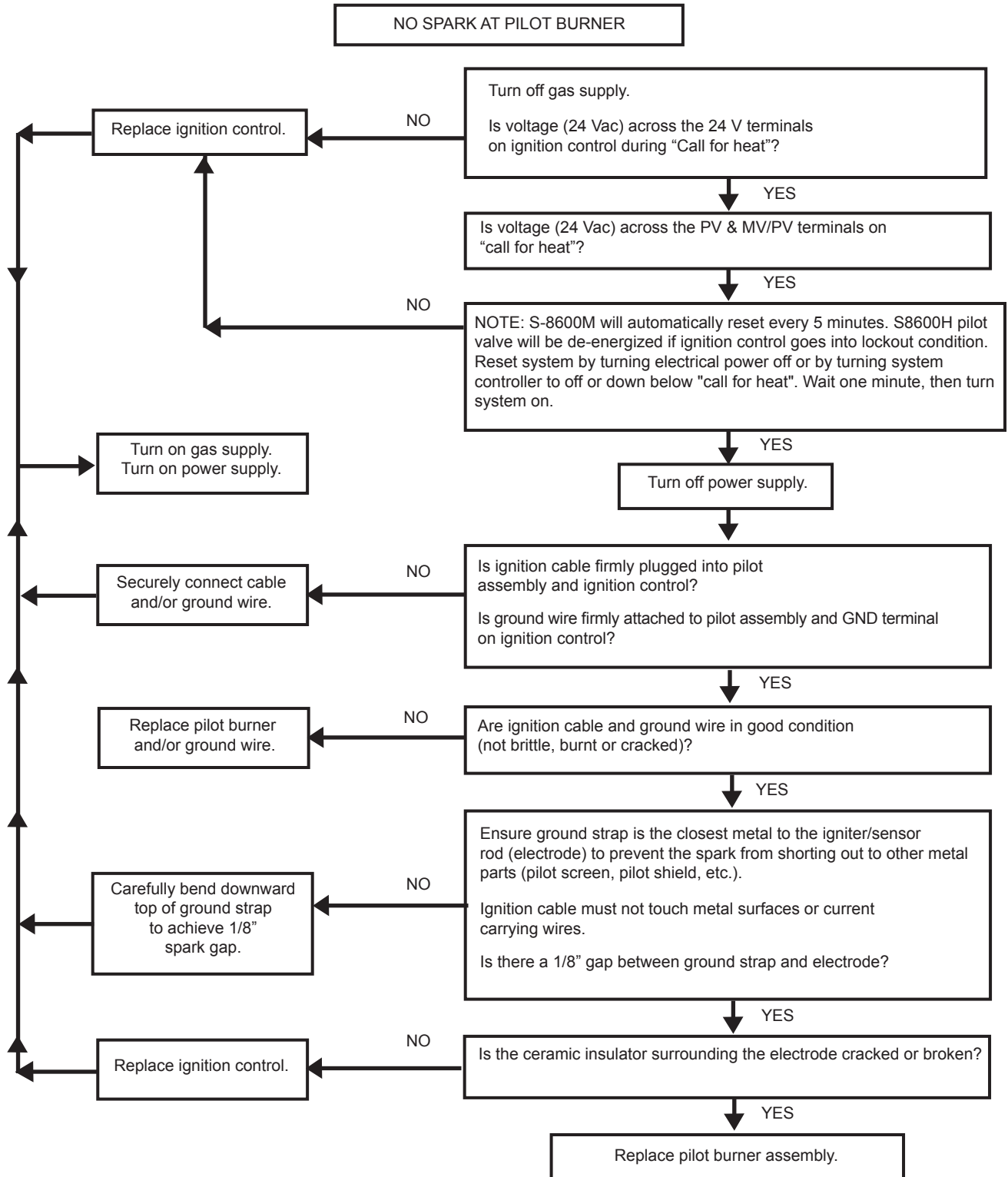

CHECKING INTERMITTENT IGNITION CONTROLS

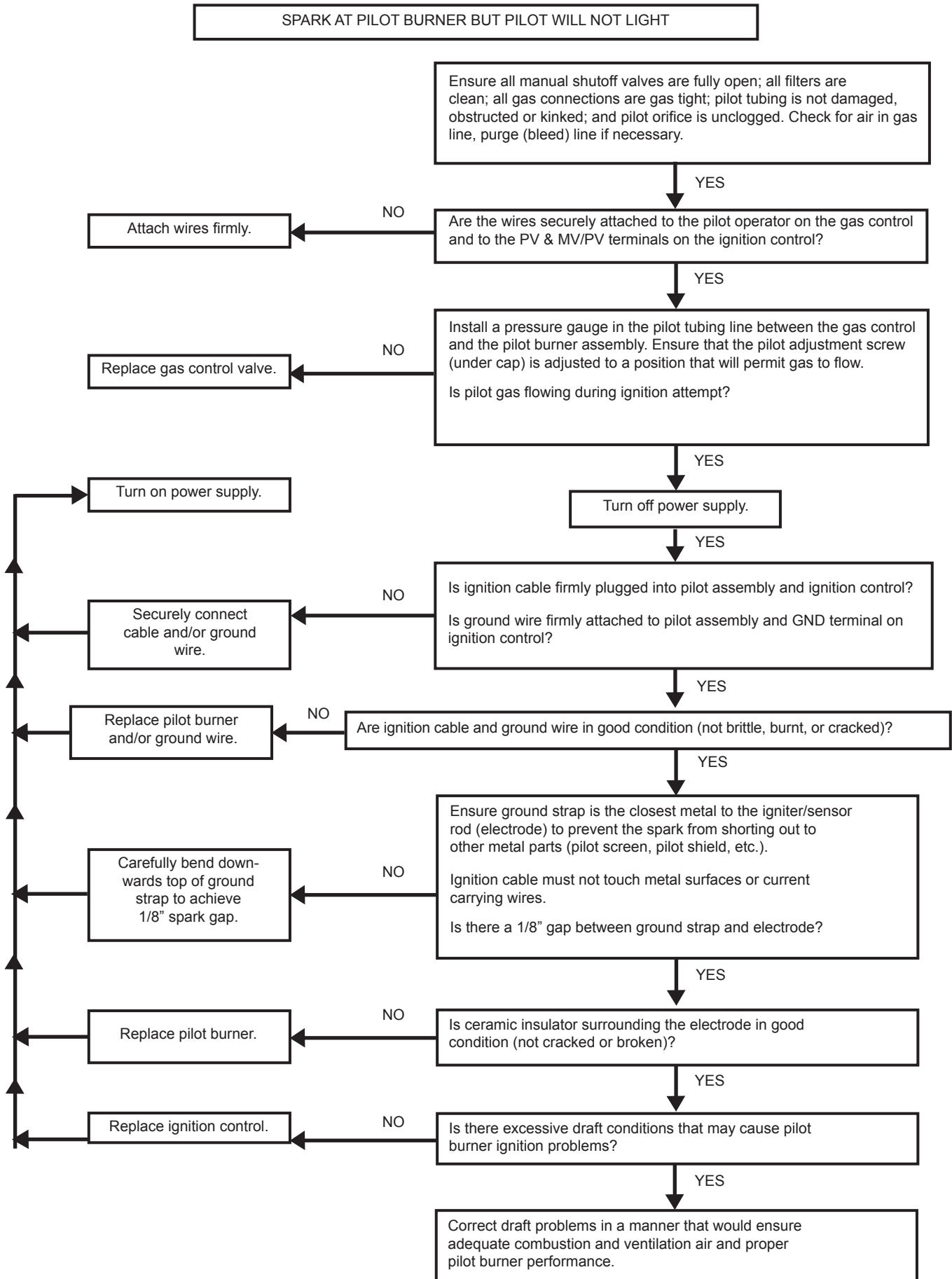

CHECKING INTERMITTENT IGNITION CONTROLS

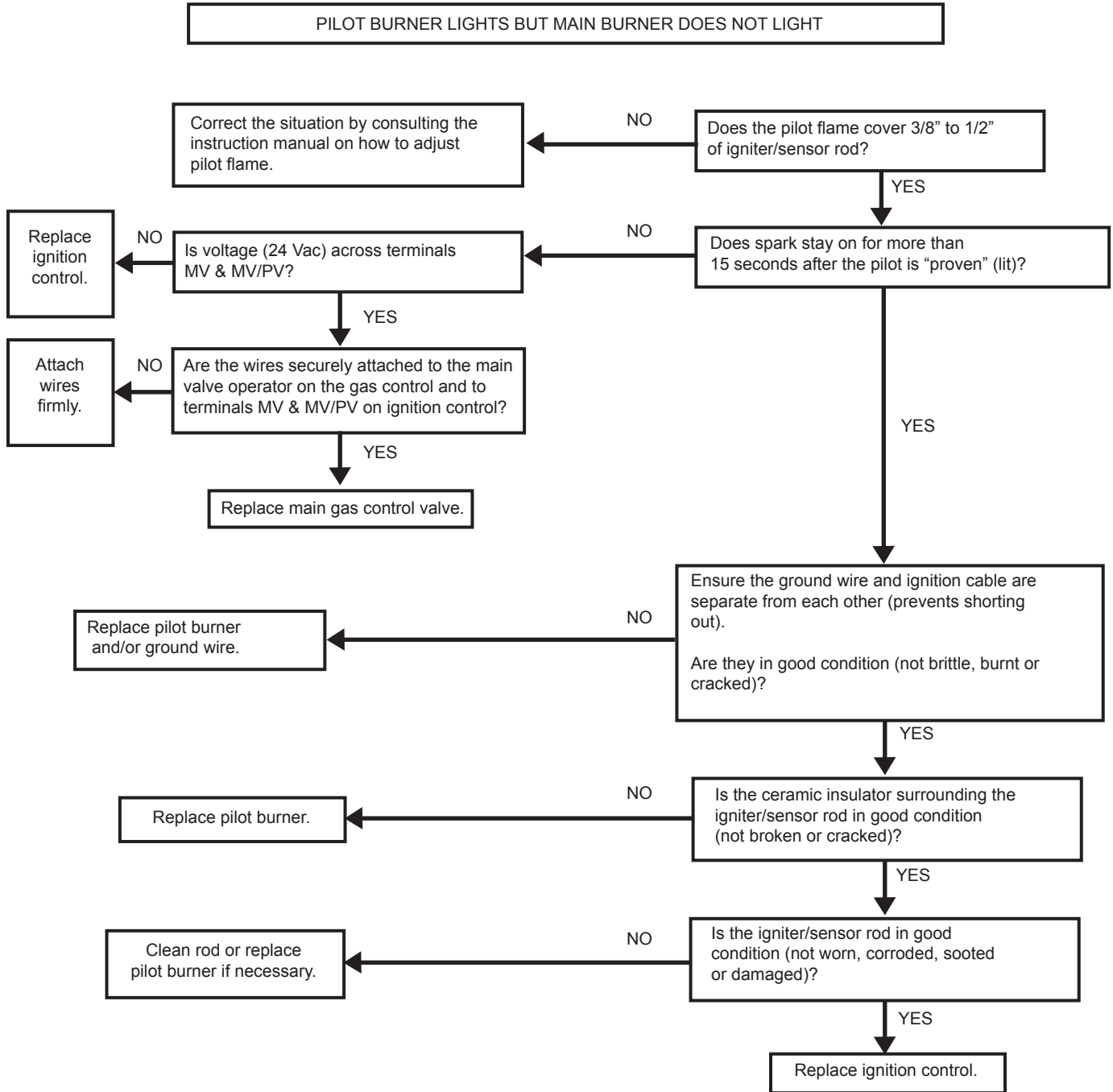

CHECKING INTERMITTENT IGNITION CONTROLS

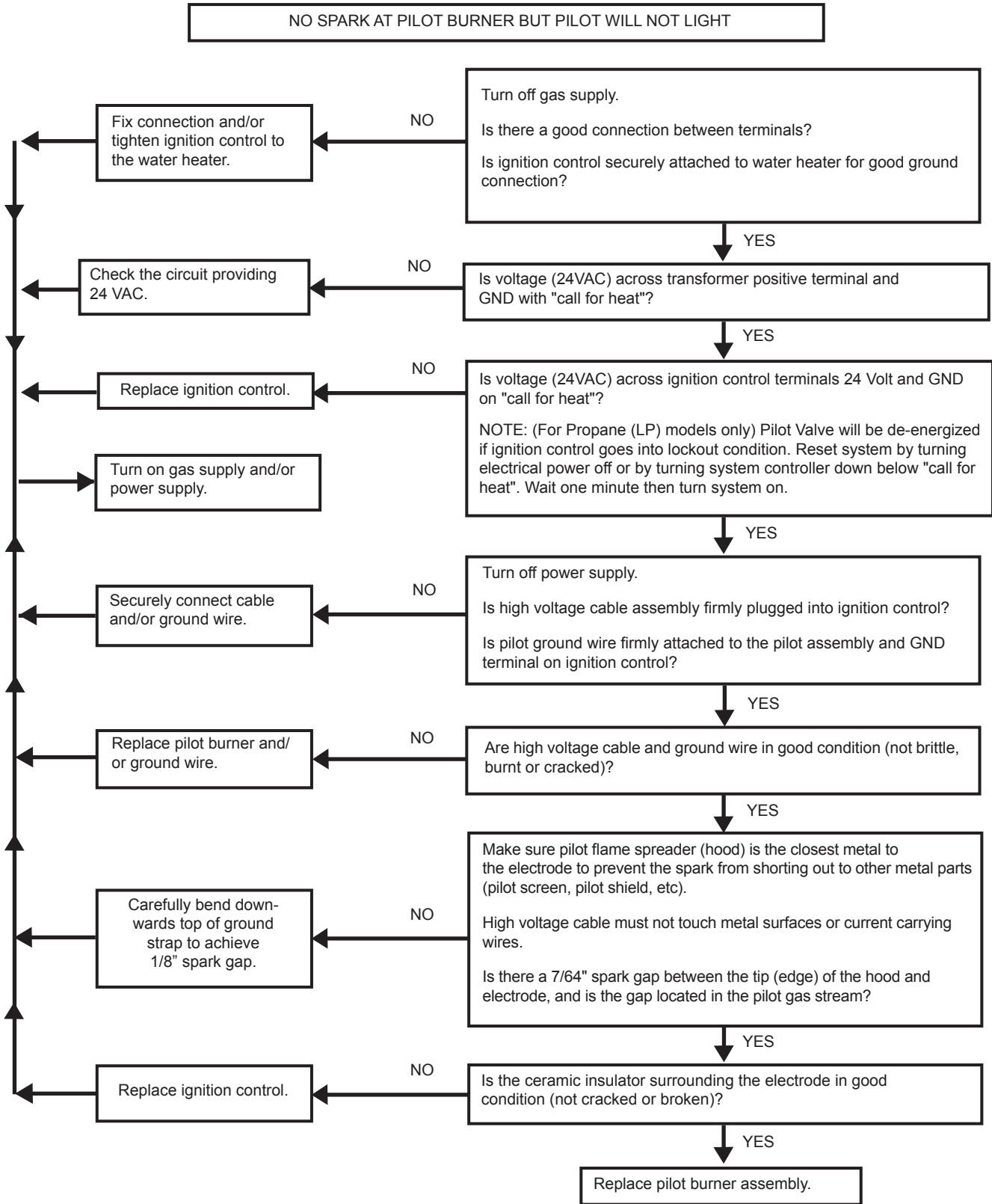

LED STATUS AND TROUBLESHOOTING

The following procedures are provided as a general guide.

Any control should be replaced if it does not perform properly on checkout or troubleshooting.

In addition, replace any control if it is wet or looks like it has ever been wet.

The control has one LED used for flame sensing and system status:

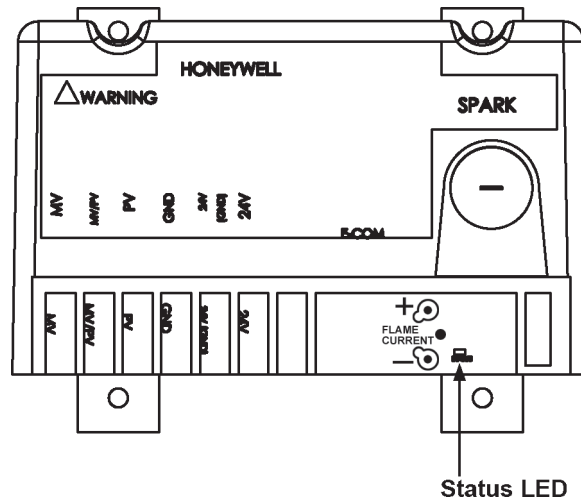

FIGURE 18. LOCATION OF LED

- Status LED (Green)
Indicates system operation status and error conditions. Refer to Table 12 and Table 13 on Page 34 for status specific to each model.

TABLE 12. CONTINUOUS RETRY MODELS C, M, E AND K ONLY - GREEN LED STATUS CODES

Green LED Flash Code ^a	Indicates	Next System Action	Recommended Service Action
OFF	No "Call for Heat"	Not applicable	None
Flash Fast	Power up - internal check	Not applicable	None
Heartbeat	Normal startup - ignition sequence started (including prepurge)	Not applicable	None
4 Seconds ON then "x" flashes	Device in run mode. "x" = flame current to the nearest μ A.	Not applicable	None
2	5 minute Retry Delay - Pilot flame not detected during trial for ignition	Initiate new trial for ignition after retry delay completed.	If system fails to light on next trial for ignition check gas supply, pilot burner, spark and flame sense wiring, flame rod contaminated or out of position, burner ground connection.
3	Recycle - Flame failed during run	Initiate new trial for ignition. Flash code will remain through the ignition trial until flame is proved.	If system fails to light on next trial for ignition, check gas supply, pilot burner, flame sense wiring, contamination of flame rod, burner ground connection.
4	Flame sensed out of sequence	If situation self corrects within 10 seconds, control returns to normal sequence. If flame out of sequence remains longer than 10 seconds, control will resume normal operation 1 hour after error is corrected.	Check for pilot flame. Replace gas valve if pilot flame present. If no pilot flame, cycle "Call for Heat." If error repeats, replace control.
6	Control Internal Error	Control remains in wait mode. When the fault corrects, control resumes normal operation.	Cycle "Call for Heat". If error repeats, replace control.
7	Flame rod shorted to ground	Control remains in wait mode. When the fault corrects, control resumes normal operation.	Check flame sense lead wire for damage or shorting. Check that flame rod is in proper position. Check flame rod ceramic for cracks, damage or tracking.
8	Low secondary voltage supply	Control remains in wait mode. When the fault corrects, control resumes normal operation.	Check transformer and AC line for proper input voltage to the control. Check with full system load on the transformer

TABLE 13. LOCKOUT MODELS B, H D, AND J ONLY—GREEN LED STATUS CODES

Green LED Flash Code ^a	Indicates	Next System Action	Recommended Service Action
OFF	No "Call for Heat"	Not applicable	None
Flash Fast	Power up - internal check	Not applicable	None
Heartbeat	Normal startup - ignition sequence started (including prepurge)	Not applicable	None
4 Seconds ON then "x" flashes	Device in run mode. "x" = flame current to the nearest μ A.	Not applicable	None
2	Lockout - Failed trial for ignition	Remain in lockout until "Call for Heat" is cycled.	Check gas supply, pilot burner, spark and flame sense wiring, flame rod contaminated or out of position, burner ground connection.
3	Recycle - Flame failed during run	Initiate new trial for ignition. Flash code will remain through the ignition trial until flame is proved.	If system fails to light on next trial for ignition, check gas supply, pilot burner, flame sense wiring, contamination of flame rod, burner ground connection.
4	Flame sensed out of sequence	If situation self corrects within 10 seconds, control returns to normal sequence. If flame out of sequence remains longer than 10 seconds, control will resume normal operation 1 hour after error is corrected.	Check for pilot flame. Replace gas valve if pilot flame present. If no pilot flame, cycle "Call for Heat." If error repeats, replace control.
6	Control Internal Error	Control remains in wait mode. When the fault corrects, control resumes normal operation.	Cycle "Call for Heat". If error repeats, replace control.
7	Flame rod shorted to ground	Control remains in wait mode. When the fault corrects, control resumes normal operation.	Check flame sense lead wire for damage or shorting. Check that flame rod is in proper position. Check flame rod ceramic for cracks, damage or tracking.
8	Low secondary voltage supply	Control remains in wait mode. When the fault corrects, control resumes normal operation.	Check transformer and AC line for proper input voltage to the control. Check with full system load on the transformer.

^aFlash Code Descriptions:

- Flash Fast: rapid blinking.
- Heartbeat: Constant ½ second bright, ½ second dim cycles.
- 4 second solid on pulse followed by "x" 1 second flashes indicates flame current to the nearest μ A. This is only available in run mode.
- A single flash code number signifies that the LED flashes X times at 2Hz, remains off for two seconds, and then repeats the sequence.

FLAME CURRENT MEASUREMENT

Flame current of the device can be measured using a standard micro-ammeter by simply inserting the meter probes into the holes labeled FLAME CURRENT, as shown in Figure 19.

- Flame current must be measured with pilot valve lit but no main gas flowing.
- Disconnect MV leadwire from the control before measuring flame current.
- Set meter to DC μ Amp scale.
- Ensure meter leads are positioned correctly [+/-].

NOTE: Trying to measure the pilot flame current in series with the wiring will not be accurate.

Recommended Minimum Pilot Only Flame Current:

- Must read steady 1 μ Amp DC minimum.
- Flame current should be 2 μ Amp or greater for reliable appliance operation.

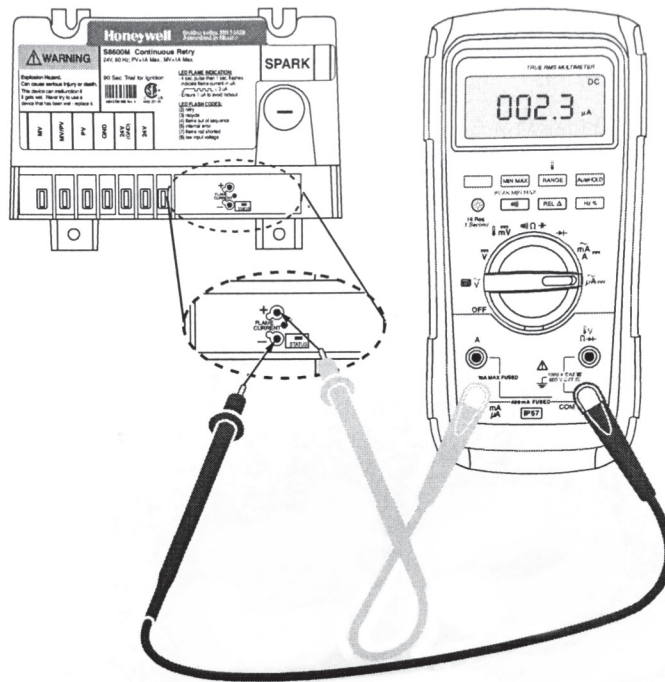

FIGURE 19. MEASURING PILOT FLAME CURRENT WITH MICRO-AMMETER.

GENERAL MAINTENANCE

These water heaters are designed to give many years of efficient and satisfactory service when properly operated and maintained. To assure continued good performance, the following recommendations are made.

The area around the water heater should be kept clean and free from lint and debris. Sweeping the floor around the water heater should be done carefully. This will reduce the dust and dirt that can cause improper combustion and sooting if it enters the burner and pilot air passages.

The flow of combustion and ventilation air to the water heater must not be obstructed. The water heater area must be kept clear and free from combustible materials, gasoline, and other flammable vapors and liquids.

All pressure relief valves should be inspected and manually operated at least twice a year. More frequent inspections may be necessary depending on water conditions.

Periodic checks, at least twice a year, should be made for water and/or gas leaks.

The water heater mounted gas and electrical controls have been designed to give both dependable service and long life. However, malfunction can occur, as with any piece of equipment. It is therefore recommended that all components be checked periodically by a qualified service agency for proper operation.

MANUAL RESET HIGH LIMIT SWITCH CONTINUITY TEST

Do not depress the switch reset button prior to testing. With the water heater being cold, disconnect the leads from the switch. With a multimeter place a probe on each side of the switch. If the meter reads zero the switch is good. If you receive an infinite or OL signal, the reason could be:

1. Switch contacts open.
 - Depress reset button on switch (switch cannot be reset until water temperature in the water heater coils drop below 204°F). Meter should read zero.
2. Defective switch.
 - With leads attached, depress the switch button. If the meter does not read zero, the switch is defective and must be replaced.

PRESSURE RELIEF VALVE TEST

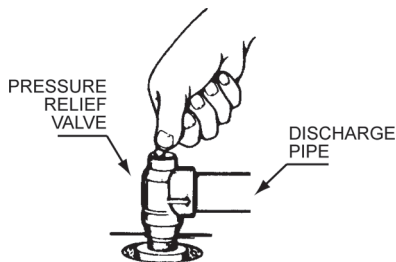
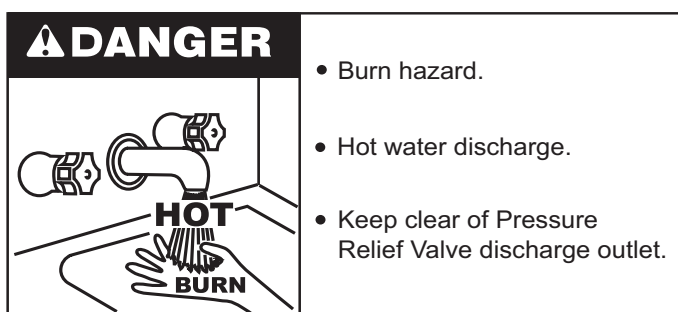

FIGURE 20. PRESSURE RELIEF VALVE TEST

The pressure relief valve should be operated at least twice a year to check its working condition. Before testing the pressure relief valve, verify that a discharge pipe is installed on the pressure

relief valve. The discharge pipe should terminate at an adequate floor drain to insure against personal contact with hot water and to prevent water damage from the release of hot water. To test the valve, lift the lever on the valve several times until the valve seats properly and operates freely.

If after manually operating the valve, it fails to completely reset and continues to release water, turn off power to the water heater at the main disconnect switch or breaker. Close the cold water inlet to the water heater and drain the water heater. Should the pressure relief valve need to be replaced, call the toll free phone number listed on the back of this manual for further technical assistance.

If the relief valve discharges periodically, this may be due to thermal expansion in a closed water supply system. Contact the water supplier or local plumbing inspector on how to correct this situation. Do not plug the relief valve.

PILOT AND MAIN BURNER

To maintain safe operation of the water heater, check the pilot and the main burner once every six months for proper flame characteristics.

1. MAIN BURNER

The main burner, Figure 21, should display the following characteristics:

- Provide complete combustion of gas.
- Cause rapid ignition and carryover of flame across all burners.
- Give reasonably quiet operation during ignition, burning and extinction.
- Cause no excessive lifting of flame from burner ports.

If these burner characteristics are not evident, check for accumulation of lint or other foreign material that restricts or blocks the air openings to the burner or water heater.

Also check for good flow of combustion and ventilating air to the unit. Maintain a clear area around the water heater at all times.

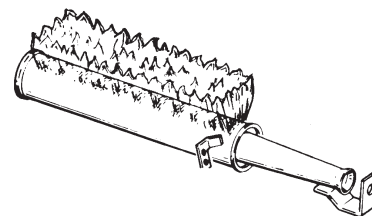

FIGURE 21. MAIN BURNER

The water heater should be periodically inspected by a qualified service agency for continuous safe operation.

Qualified service agencies should follow this procedure when the water heater's burners need cleaning.

- a. Turn off the electrical power and close the main manual gas shutoff valve. Refer to Operating Instructions on Page 27.
 - Allow water heater parts to cool before disassembly.
- b. Remove main burner manifold assembly from water heater.
 - Refer to parts list supplied with this manual for disassembly aid.
- c. Remove any loose foreign material such as dust or lint with a vacuum. Check all ports, orifices, and air openings for blockage. Dislodge and remove any foreign material causing blockage. Remove any soot or carbon deposits with a rag making sure to remove any lint left on burners by vacuuming again.
- d. Reinstall the burner manifold assembly on water heater.
- e. Restore electrical power and gas supply to the water heater.
 - Put the water heater back in operation by following the operating instructions in this manual or on the operating instruction label on the water heater. Refer to Page 27.
 - Check for gas leaks and proper water heater and vent operation.

2. PILOT BURNER - ELECTRONIC IGNITION

Servicing of the pilot burner (every six months) includes keeping pilot shield (not shown) free of lint, cleaning the burner head, the primary air opening and the orifice of the pilot burner, Figure 22.

To establish pilot flame without main burner operation, it will be necessary to perform the following steps:

- A. Open fused disconnect switch or shut off electrical power to the water heater.
- B. Disconnect the wire on the MV terminal of the gas valve.
- C. Close fused disconnect switch or restore electrical power to the water heater.

The pilot will now ignite provided the system is calling for heat.

- D. Adjust pilot flame.
- E. When the pilot is properly adjusted, replace the cap screw above the pilot adjustment screw to prevent possible gas leakage.
- F. Open the fused disconnect switch or shut off the electrical power to the water heater.
- G. Reconnect the wire to the MV terminal of the gas valve.
- H. Close the fused disconnect switch or restore power to the water heater.

To adjust the pilot flame, remove the cap screw above the pilot adjustment screw (Figure 23). Turn the pilot adjustment screw to

deliver a sufficient flame at the pilot burner to cover 3/8" to 1/2" (10-12 mm) of the sensing probe tip. See Figure 22.

If the pilot does not light, perform the following checks:

1. Check for good electrical connection of the sensing probe at the ignition box and both ends of the ground wire.
2. Check the pilot orifice located at the connection between the aluminum pilot gas supply tube and the pilot burner assembly. If the orifice cannot be cleaned or if it is the incorrect orifice size, replace the entire pilot assembly including the orifice.
3. Check the primary air opening of the pilot for foreign material. Clean the primary air opening if clogged.
4. If the pilot does not light after completing steps 1 through 3, check for electrical power to the gas valve. If electric power and gas are present but the gas valve and the pilot does not operate when the system calls for heat, refer to the flowchart titled "CHECKING INTERMITTENT IGNITION CONTROLS" in this manual for further diagnosis of the issue.

After getting the pilot to light, complete steps D through H above.

After returning the water heater to operating condition, check to be sure the pilot burner ignites and that the main burner fires. If the main burner fails to fire, check for gas flow to the main burner. For further assistance, see the flowchart titled "CHECKING INTERMITTENT IGNITION CONTROLS" in this manual to help diagnose the issue.

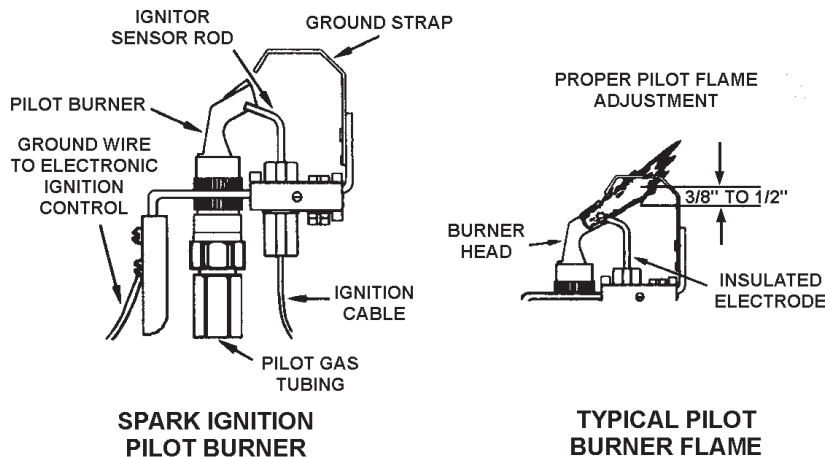

FIGURE 22. SPARK IGNITION PILOT BURNER AND BURNER FLAME

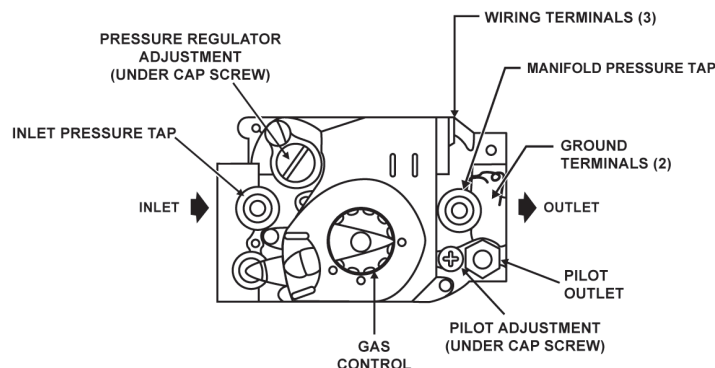

FIGURE 23. ADJUSTING PILOT FLAME

THERMAL BALANCER (HWH-200, HWH-225)

Figure 24 shows the internal wiring of the thermal balancer. The device may be tested after disconnecting the four leads from their respective terminals on the unit.

1. Apply a test light to the yellow and red leads.
 - The lamp should light as the contact in this circuit is normally closed when the resistor is cool.
2. Apply a light to the black and yellow leads.
 - The lamp should not light as the contact in this circuit is normally open when the resistor is cool.
3. Remove the test light.
4. Apply 120 volts to the white and red leads which power the 1900 ohm resistor. After a warming period the contacts of the thermal balancer should operate.
5. Remove the 120 volt power source.
6. Apply the test light as described in steps 1 and 2.

While the resistor is still warm the lamp indications should be the opposite as described previously. If this is not the case, replace the thermal balancer.

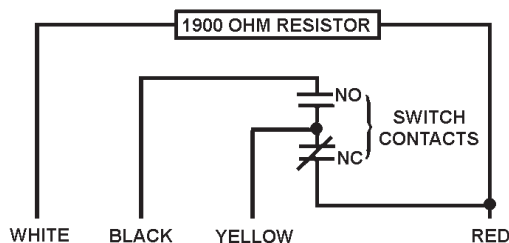
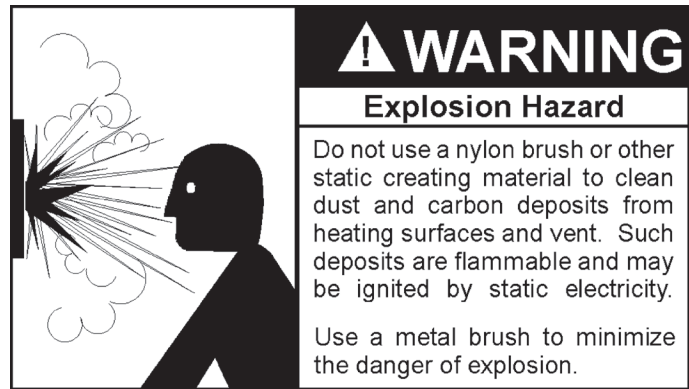

FIGURE 24. THERMAL BALANCER

VENTING MAINTENANCE

It is recommended that the heating surfaces and vent piping of the water heater be checked every six months for dust, deterioration and carbon deposits. Remove all soot or other obstructions from chimney and flue which will retard free draft. Replace any damaged or deteriorated parts of the venting system.

Qualified service agencies should follow this procedure when the water heater's external heating surfaces and vent pipe need cleaning.



1. Turn off the electrical power (main manual gas shutoff and pilot valves, if applicable).
 - Allow water heater parts and vent to cool before disassembly.
2. Remove the water heater draft hood and vent pipe running to the chimney.
 - Check parts and chimney for obstructions and clean as necessary.
3. Remove burner from water heater and other metal parts as required to clean and vacuum the heat exchanger and combustion coils.
 - Refer to parts list supplied with this manual for disassembly aid.
4. Reinstall the parts removed in steps 2 and 3.
 - Be sure the vent pipe has a minimum upward pitch of one quarter inch per foot of length (21 mm/m) and is sealed as necessary.
5. Restore electrical power and gas supply to water heater.
 - Place water heater in operation by following the operating instructions on page 27.
 - Check for gas leaks and proper water heater and vent operation.

LIME SCALE REMOVAL

Scale deposits inside of the heat exchanger and coil can occur in areas with hard water. Symptoms of lime build-up are lack of hot water, extended heating cycles, noisy operation, and/or a change in the temperature rise through the water heater compared to the temperature rise recorded during the original start-up of the water heater. More information about lime build up and how to delime the water heater can be found in the online Service Handbook for boilers titled "Deliming copper tube heat exchanger manual".

CIRCULATING PUMP

The circulating pump may require periodic lubrication. Refer to the circulating pump manufacturers instructions for lubrication procedures and lubrication frequency.

WIRING

WIRING CONNECTIONS



⚠ CAUTION

Label all wires prior to disconnection when servicing controls. Wiring errors can cause improper and dangerous operation. Verify proper operation after servicing.

CONVENTIONAL INSTALLATIONS

All electrical work must be installed in accordance with current editions National Electrical Code, ANSI/NFPA 70 and/or the Canadian Electrical Code, PART 1, CSA C22.1, Electrical Code and must conform to local regulations.

The water heater, when installed, must be electrically bonded to ground in accordance with the requirements of the authority having jurisdiction or, in the absence of such requirements, with the current editions National Electrical Code, ANSI/NFPA 70 and/or the Canadian Electrical Code, PART 1, CSA C22.1, Electrical Code.

Strict adherence to piping and wiring diagrams is required to prevent constant pump operation when system temperature control is satisfied. Otherwise the warranty is void as stipulated in the limited warranty on the instruction manual.

The electrical connections must be made so that the circulating pump will operate before the gas control valve opens. At no time

may the controlling system allow the burner to fire when there is no water flow through the water heaters.

Refer to the connection and schematic diagrams on the following pages for proper wiring sequence with conventional water heater installations.

The thermal balancer shown is factory included on HWH-200 and HWH-225 models by A. O. Smith. This device serves as a pump shutdown delay switch to balance the rising water heater water temperature to system temperature before the pump stops. Overshooting of water heater temperature is prevented and stack loss after shutdown is negligible.



⚠ WARNING

An electrical ground is required to reduce risk of electric shock or possible electrocution. Make the ground connection to the screw provided in the electrical supply junction box on the water heater.

If any of the original wire, as supplied with the water heater, must be replaced, it must be replaced with type 105°C wire or its equivalent, except for the flame sensor and ignition cable which are 250°C and wires connected to the manual limit switch which are 200°C.

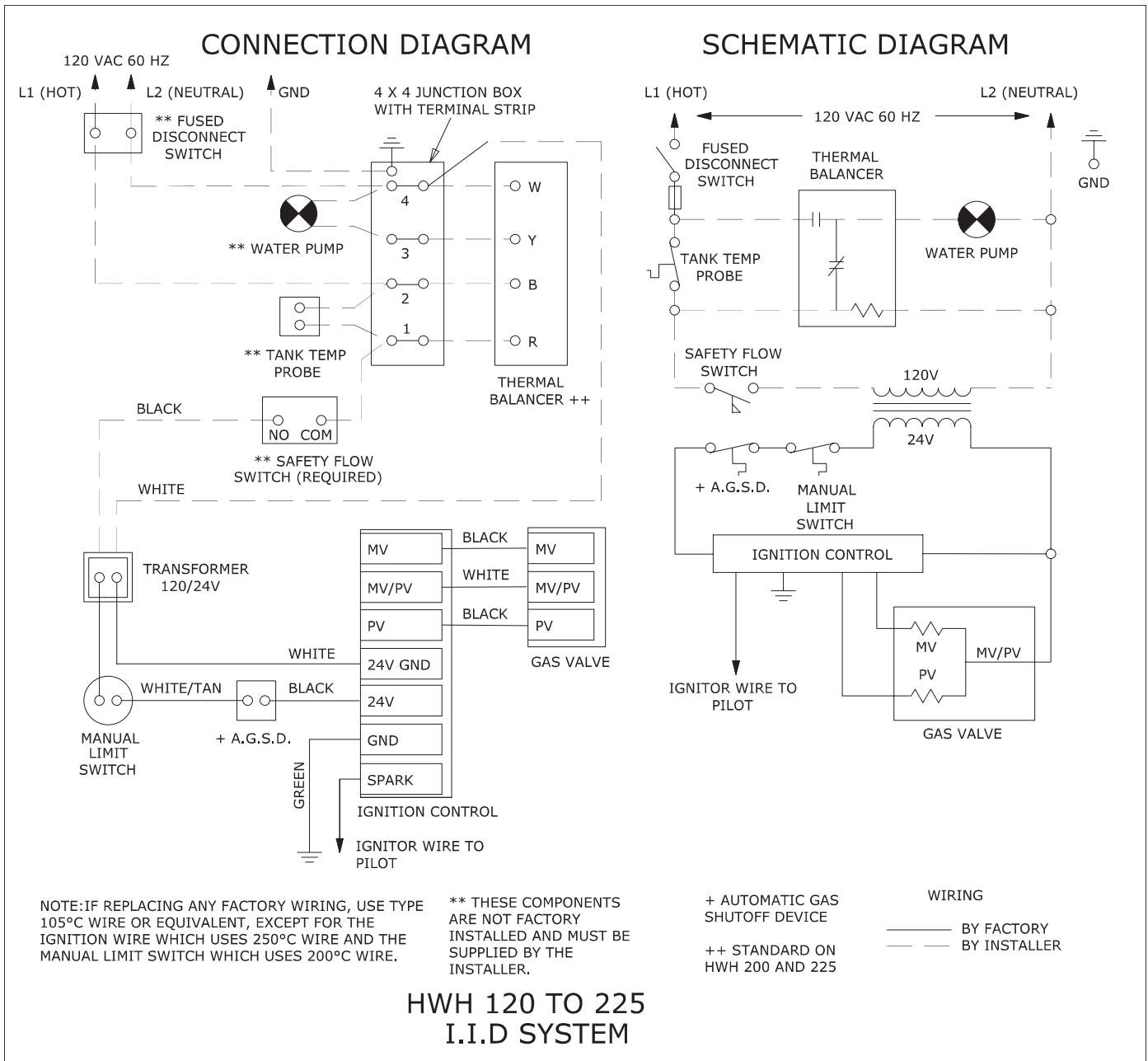

FIGURE 25. WIRING DIAGRAMS

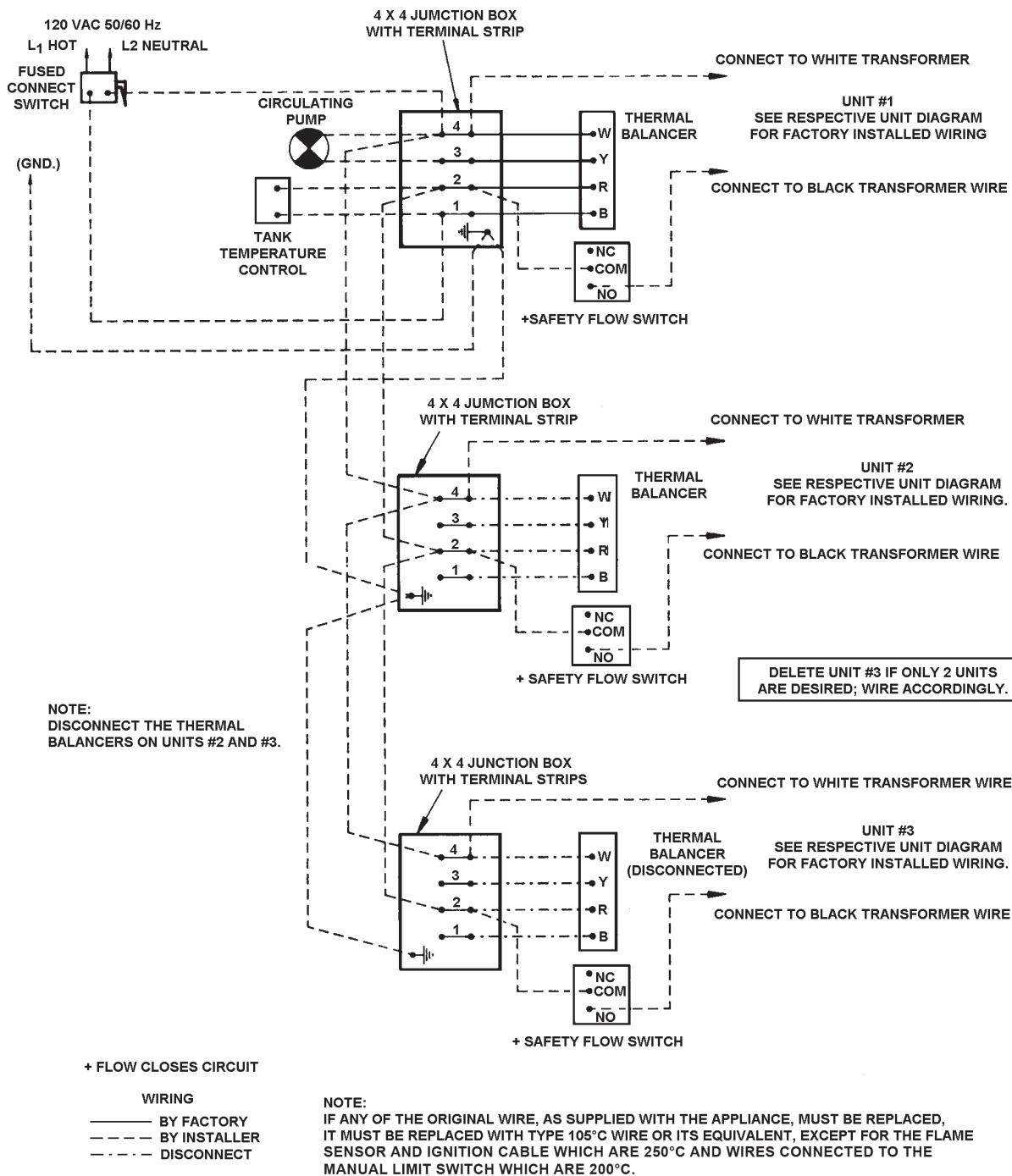

FIGURE 28. CER - TEMP 80 - 2 OR 3 UNIT INSTALLATION CONNECTION DIAGRAM - FOR HOT WATER SUPPLY APPLICATION

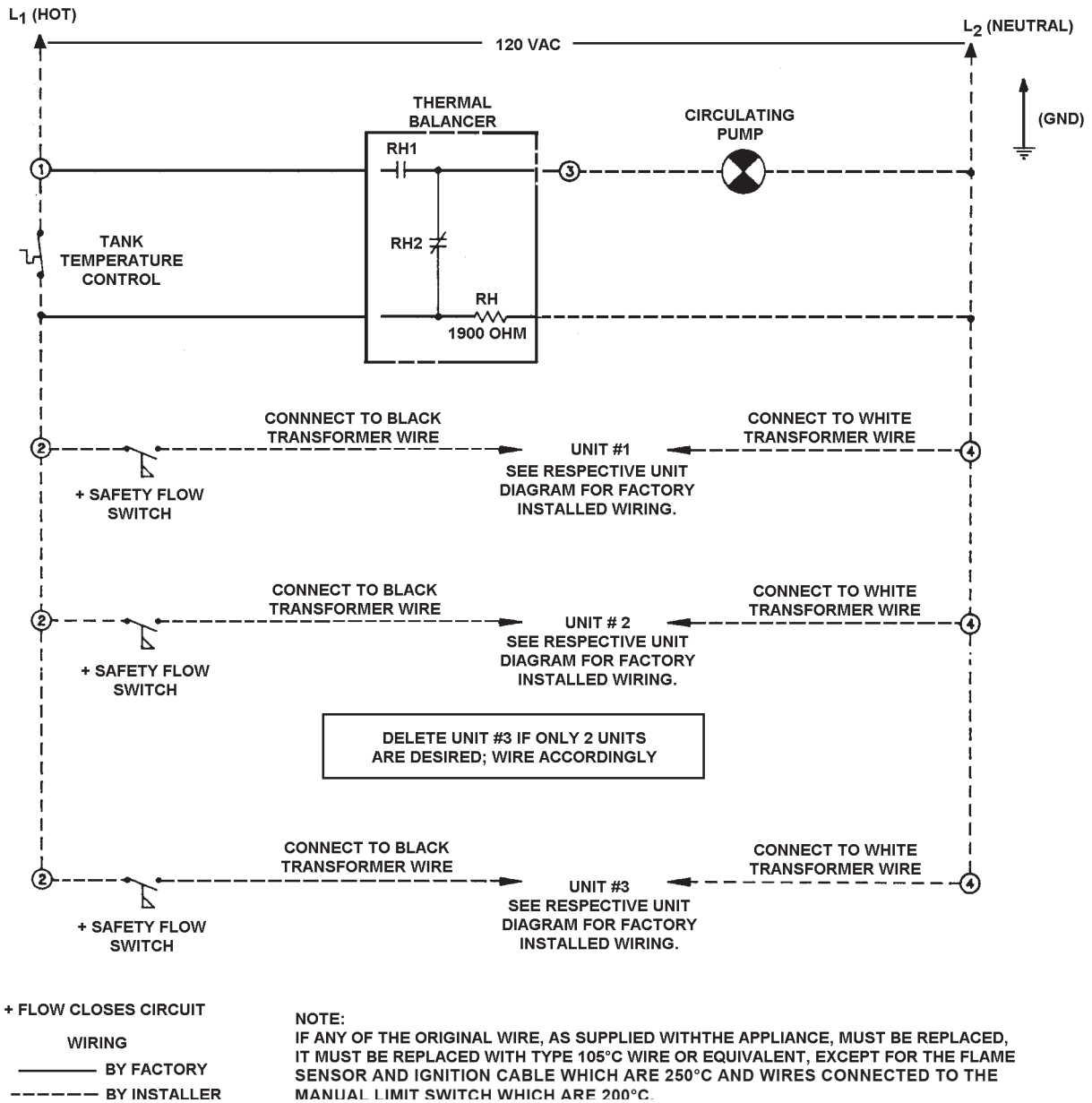
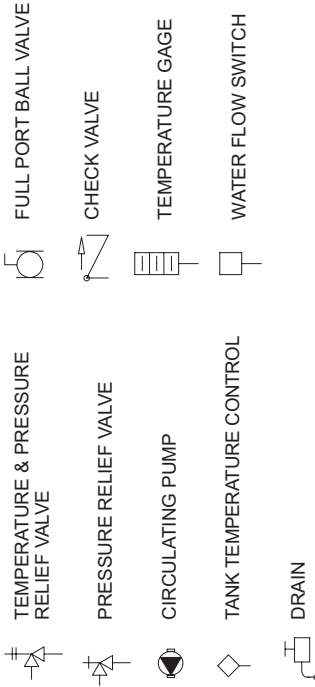

FIGURE 29. CER - TEMP 80 - 2 OR 3 UNIT INSTALLATION SCHEMATIC DIAGRAM - FOR HOT WATER SUPPLY APPLICATION

PIPING DIAGRAMS

LEGEND



BURKAY HWH(300-670) -ONE TEMPERATURE-ONE WATER HEATER/VERTICAL STORAGE TANK RECOVERY SYSTEM

WARNING: THIS DRAWING SHOWS SUGGESTED PIPING CONFIGURATION AND OTHER DEVICES; CHECK WITH LOCAL CODES AND ORDINANCES FOR ADDITIONAL REQUIREMENTS.

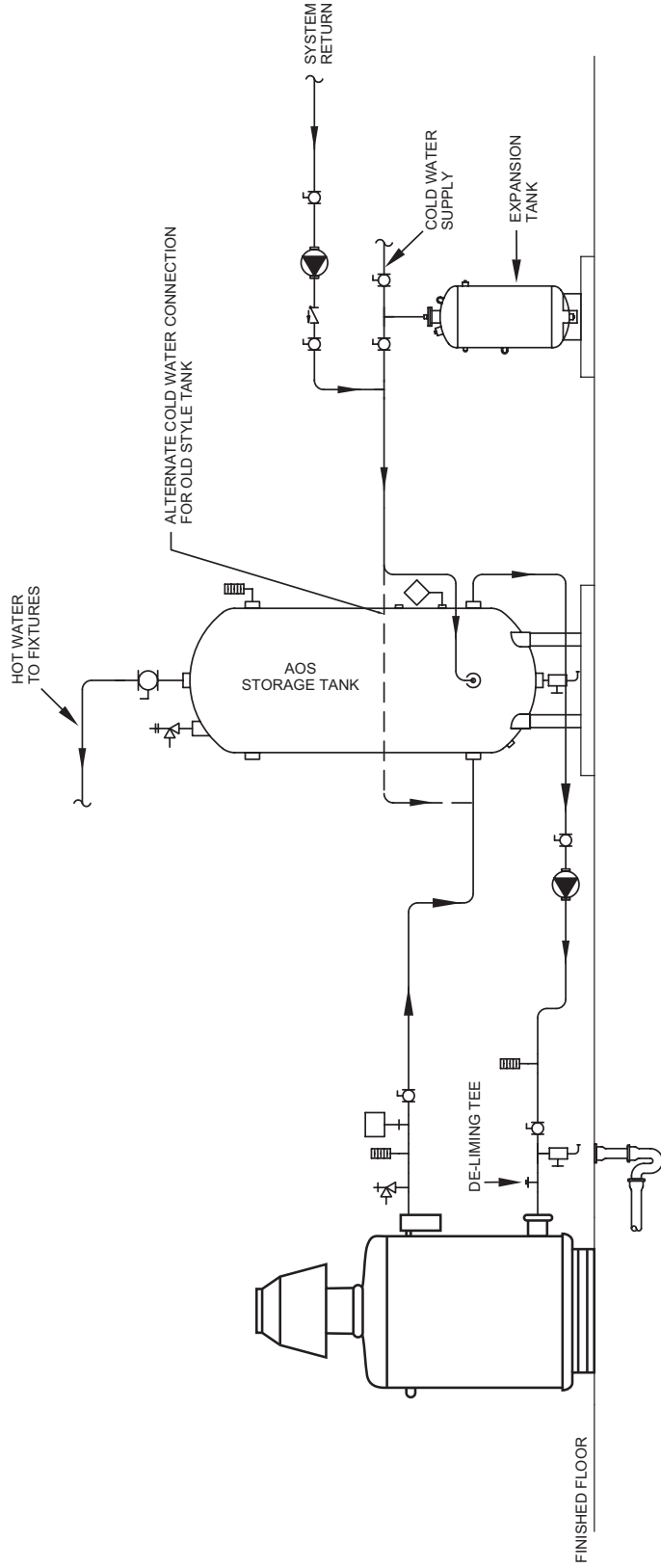

NOTES:

1. Preferred piping diagram.
2. The temperature and pressure relief valve setting shall not exceed pressure rating of any component in the system.
3. Service valves are shown for servicing unit. However, local codes shall govern their usage.
4. A. O. Smith piping method is based on 50 equivalent feet of piping. Water heater placement shall be as close as practical to the storage tank. Applications in excess of these recommendations shall require a licensed engineer for design assistance.

FIGURE 30. ONE TEMPERATURE - ONE WATER HEATER/ VERTICAL STORAGE TANK RECOVERY SYSTEM

LEGEND

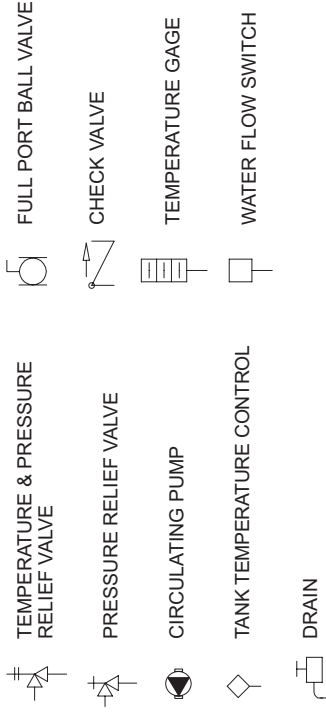

BURKAY HWH(300-670) - ONE TEMPERATURE-ONE WATER HEATER/HORIZONTAL STORAGE TANK RECOVERY SYSTEM

WARNING: THIS DRAWING SHOWS SUGGESTED PIPING CONFIGURATION AND OTHER DEVICES; CHECK WITH LOCAL CODES AND ORDINANCES FOR ADDITIONAL REQUIREMENTS.

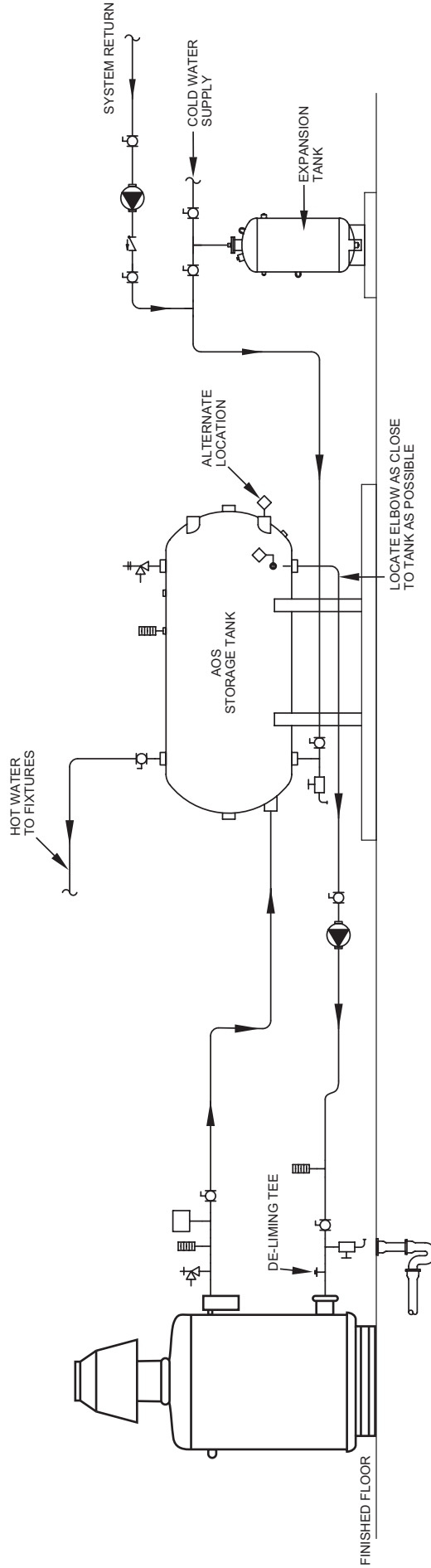

NOTES:

1. Preferred piping diagram.
2. The temperature and pressure relief valve setting shall not exceed pressure rating of any component in the system.
3. Service valves are shown for servicing unit. However, local codes shall govern their usage.
4. A. O. Smith piping method is based on 50 equivalent feet of piping. Water heater placement shall be as close as practical to the storage tank. Applications in excess of these recommendations shall require a licensed engineer for design assistance.

FIGURE 31. ONE TEMPERATURE - ONE WATER HEATER/ HORIZONTAL STORAGE TANK RECOVERY SYSTEM

NOTES

LIMITED WARRANTY

COMMERCIAL CIRCULATING WATER HEATER LIMITED WARRANTY



EFFECTIVE

If within FIVE years after initial installation of the water heater, a heat exchanger or gas burner shall prove upon examination by the warrantor to be defective in material or workmanship, the warrantor, at his option will exchange or repair such part or portion.

For 1 Year, in the event of part failure, we will repair or, at our discretion, replace the defective part.

We warrant this product against defects in materials or workmanship as described in this document if installed within the United States or Canada and provided the product remains at its original place of installation.

Warranty coverage begins the date of installation OR the date of manufacture if installation cannot be verified.

WHAT'S COVERED

Subject to these terms, in the event of defect in materials and/or workmanship resulting in a **heat exchanger leak** during the **first five years**, we will:

- Replace or repair the heat exchanger.

Subject to these terms, in the event of a defect in materials and/or workmanship appearing during the **first year**, we will:

- Repair or, at our discretion, replace any part of the water heater covered under this limited warranty excluding parts subject to normal maintenance (Example: non-electronic anode rod, filter, etc)

Service / labor, shipping, delivery, installation, handling or any other costs are not covered at any time under this warranty.

Any replacement part or product will be warranted only for the unexpired portion of the original water heater's limited warranty period.

WHAT'S NOT COVERED

- Problems caused by improper: gas supply line sizing, gas type, venting, connections, combustion air, voltage, wiring, or fusing
- Failure to follow applicable codes
- Failure to follow printed instructions
- Abuse, misuse, accident, fire, flood, Acts of God
- Improper installation, sizing, delivery, or maintenance
- Claims related to rust, noise, smell, or taste of water
- Failure to conduct authorized factory start up if required
- Alterations to the water heater
- Non-outdoor heaters installed outdoors
- Damages due to a failure to allow for thermal expansion
- Heat exchanger failure due to lack of adequate / proper supply of water
- Heaters moved from their original location
- Service trips to explain proper installation, use, or maintenance of the product/unit or to describe compliance requirements under applicable codes and regulations
- Charges related to accessing your heater including but not limited to door/wall removal, equipment rental, etc.
- Replacement parts after expiration of this warranty

LIMITATIONS

NOTWITHSTANDING ANYTHING ELSE TO THE CONTRARY, THIS IS YOUR SOLE AND EXCLUSIVE WARRANTY. ALL OTHER WARRANTIES INCLUDING A WARRANTY OF MERCHANTABILITY OR FITNESS FOR PARTICULAR PURPOSE ARE EXPRESSLY DISCLAIMED. SELLER SHALL NOT BE LIABLE FOR ANY CONSEQUENTIAL, INCIDENTAL, SPECIAL, PUNITIVE OR OTHER INDIRECT DAMAGES. TOTAL LIABILITY ARISING AT ANY TIME SHALL NOT EXCEED THE PURCHASE PRICE PAID WHETHER BASED ON CONTRACT, TORT, STRICT LIABILITY OR ANY OTHER LEGAL THEORY.

SERVICE INQUIRIES:

For service inquiries call the telephone number listed below. Be prepared to provide the following information: name, address, and telephone number; the model and serial number of the water heater; proof of installation; and a clear description of the problem.

For your records, fill in the product:

Serial: _____
Model: _____

U.S. Customers:

A. O. Smith Corporation
500 Tennessee Waltz Parkway
Ashland City, Tennessee 37015
800-527-1953
www.hotwater.com

Canadian Customers:

P. O. Box 310 – 768 Erie Street
Stratford (Ontario) N5A 6T3
800-265-8520



25589 Highway 1, McBee, SC 29101
Technical Support: 800-527-1953 • Parts: 800-433-2545 • Fax: 800-644-9306
www.hotwater.com