

COMMERCIAL GAS WATER HEATERS



500 Tennessee Waltz Parkway
Ashland City, TN 37015



MODELS BTP(V)-540(A), 650(A), 740(A)

SERIES 104/105

INSTALLATION - OPERATION - SERVICE
- MAINTENANCE - LIMITED WARRANTY



WARNING: If the information in these instructions is not followed exactly, a fire or explosion may result causing property damage, personal injury or death.

- Do not store or use gasoline or other flammable vapors and liquids in the vicinity of this or any other appliance.
- **WHAT TO DO IF YOU SMELL GAS:**
 - Do not try to light any appliance.
 - Do not touch any electrical switch; do not use any phone in your building.
 - Immediately call your gas supplier from a neighbor's phone. Follow the gas supplier's instructions.
 - If you cannot reach your gas supplier, call the fire department.
- Installation and service must be performed by a qualified installer, service agency or the gas supplier.

Thank you for buying this energy efficient water heater. We appreciate your confidence in our products.



⚠ WARNING

Read and understand this instruction manual and the safety messages herein before installing, operating or servicing this water heater.

Failure to follow these instructions and safety messages could result in death or serious injury.

This manual must remain with the water heater.

PLACE THESE INSTRUCTIONS ADJACENT TO HEATER AND NOTIFY OWNER TO KEEP FOR FUTURE REFERENCE.

TABLE OF CONTENTS

SAFE INSTALLATION, USE AND SERVICE.....	3	Vent Connection.....	18
APPROVALS.....	3	Horizontal (Side-Wall) Venting for BTPV Models.....	18-19
GENERAL SAFETY INFORMATION.....	4-5	Direct Venting for BTPV Models.....	19
Precautions.....	5	Termination Clearances Sidewall Power Vent.....	20
Grounding Instructions.....	5	Termination Clearances Sidewall Direct Vent.....	21
Hydrogen Gas Flammable.....	5	WATER HEATER INSTALLATION.....	24
INTRODUCTION.....	6	Water Line Connections.....	24
Abbreviations Used.....	6	T&P Valve Discharge Pipe.....	24
Qualifications.....	6	Installation Diagrams - Top Inlet/Outlet Usage.....	25
Start Up Requirements.....	6	Heater Wiring.....	25-26
Preparing for the Installation.....	6	Gas Piping.....	26-27
FEATURES AND COMPONENTS.....	7	Gas Line Leak Testing.....	27
High Limit Switch.....	7	Purging.....	27
Electronic Ignition Control.....	7	START-UP AND OPERATION.....	28
Barometric Draft Control.....	7	Prior to Start Up.....	28
Uncrating.....	7	SEQUENCE OF OPERATION.....	28-29
INSTALLATION CONSIDERATIONS.....	8-12	Lighting & Operation Label.....	30
Rough In Dimensions.....	8	Adjustments.....	31
Locating The Water Heater.....	10	Adjustment Procedure for Fire-Rate, Low NOX and High Elevation (Fine-Tune).....	31
Clearances.....	10	MAINTENANCE.....	34
Insulation Blanket.....	11	Venting System and Barometric Draft Control.....	34
Hard Water.....	11	General.....	34
Circulation Pumps.....	11	Remote Storage Tank Temperature Control.....	34
High Altitude Installations.....	12	Temperature-Pressure Relief Valve Test.....	34-35
INSTALLATION REQUIREMENTS.....	13-16	Anode Rod Inspection.....	35
Gas Supply Systems.....	13	Draining and Flushing.....	35
Supply Gas Regulator.....	13	Recommended Procedure for Periodic Removal or Lime Deposits from the Tank Type Commercial Water Heaters.....	35-36
Power Supply.....	13	DeLiming Solvents.....	36
Water Temperature Control and Mixing Valves.....	13-14	Tank Cleanout Procedure.....	36
Dishwashing Machines.....	14	Deliming Using Flo-Jug Method.....	36-37
Closed Water Systems.....	14	Power Burner.....	37
Thermal Expansion.....	14	Gas Control Valve.....	38
Temperature-Pressure Relief Valve.....	14-15	SERVICE.....	38
Contaminated Air.....	15	Electrical Servicing.....	38
Air Requirements.....	15	TROUBLESHOOTING.....	38-39
Unconfined Space.....	16	FOR YOUR INFORMATION.....	40
Confined Space.....	16	Start up Conditions.....	40
VENTING INSTALLATION.....	16-19	Operational Conditions.....	40
Fresh Air Opening for Confined Spaces.....	16	WATER PIPING DIAGRAMS.....	41-55
Outdoor Air Through Two Openings.....	16	MANIFOLD KITS.....	56
Outdoor Air Through One Opening.....	16-17	NOTES.....	57-58
Outdoor Air Through Two Horizontal Ducts.....	17	WARRANTY.....	59
Outdoor Air Through Two Vertical Ducts.....	17		
Air From Other Indoor Spaces.....	17		
Venting.....	17-18		
Barometric Draft Control Assembly.....	18		

SAFE INSTALLATION, USE AND SERVICE

The proper installation, use and servicing of this water heater is extremely important to your safety and the safety of others. Many safety-related messages and instructions have been provided in this manual and on your own water heater to warn you and others of a potential injury hazard. Read and obey all safety messages and instructions throughout this manual. It is very important that the meaning of each safety message is understood by you and others who install, use, or service this water heater.

	<p>This is the safety alert symbol. It is used to alert you to potential personal injury hazards. Obey all safety messages that follow this symbol to avoid possible injury or death.</p>
--	---

	<p>DANGER indicates an imminently hazardous situation which, if not avoided, will result in injury or death.</p>
	<p>WARNING indicates a potentially hazardous situation which, if not avoided, could result in injury or death.</p>
	<p>CAUTION indicates a potentially hazardous situation which, if not avoided, could result in minor or moderate injury.</p>
	<p>CAUTION used without the safety alert symbol indicates a potentially hazardous situation which, if not avoided, could result in property damage.</p>

All safety messages will generally tell you about the type of hazard, what can happen if you do not follow the safety message, and how to avoid the risk of injury.

APPROVALS

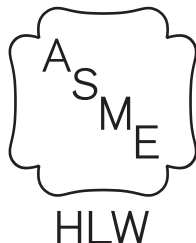

Note: ASME construction is optional on the water heaters covered in this manual.

GENERAL SAFETY INFORMATION

WARNING

Fire or Explosion Hazard

- Do not store or use gasoline or other flammable vapors and liquids in the vicinity of this or any other appliance.
- Avoid all ignition sources if you smell gas.
- Do not expose water heater controls to excessive gas pressure.
- Use only the gas shown on the water heater rating label.
- Maintain required clearances to combustibles.
- Keep ignition sources away from faucets after extended periods of non-use.



Read instruction manual before installing, using or servicing water heater.



WARNING

Fire Hazard

For continued protection against risk of fire:

- Do not install water heater on carpeted floor.
- Do not operate water heater if any part has been exposed to flooding or water damage.



WARNING

Fire and Explosion Hazard

- Use joint compound or Teflon tape compatible with propane gas.
- Leak test before placing the water heater in operation.
- Disconnect gas piping and main gas shutoff valve before leak testing.
- Install sediment trap in accordance with NFPA 54.



WARNING

Breathing Hazard - Carbon Monoxide Gas



- Install vent system in accordance with codes.
- Do not operate water heater if any part has been exposed to flooding or water damage.
- Do not operate if soot is present.
- Do not obstruct water heater air intake with insulating jacket.
- Do not place chemical vapor emitting products near water heater.
- Gas and carbon monoxide detectors are available.

Breathing carbon monoxide can cause brain damage or death. Always read and understand instruction manual.

WARNING

Fire and Explosion Hazard

- Do not use water heater with any gas other than the gas shown on the rating label.
- Excessive gas pressure to gas valve can cause serious injury or death.
- Turn off gas lines during installation.
- Contact a qualified installer or service technician for installation and service.



CAUTION

Property Damage Hazard

- All water heaters eventually leak.
- Do not install without adequate drainage.

WARNING

Electrical Shock Hazard



- Turn off power to the water heater before performing any service.
- Label all wires prior to disconnecting when performing service. Wiring errors can cause improper and dangerous operation.
- Verify proper operation after servicing.
- Failure to follow these instructions can result in personal injury or death.

WARNING

Jumping out control circuits or components can result in property damage, personal injury or death.

- Service should only be performed by a qualified service technician using proper test equipment.
- Altering the water heater controls and/or wiring in any way could result in permanent damage to the controls or water heater and is not covered under the limited warranty.
- Altering the water heater controls and/or wiring in any way could result in altering the ignition sequence allowing gas to flow to the main burner before the hot surface igniter is at ignition temperature causing delayed ignition which can cause a fire or explosion.



Any bypass or alteration of the water heater controls and/or wiring will result in voiding the water heater warranty.



GENERAL SAFETY INFORMATION



⚠️ WARNING

Read and understand this instruction manual and the safety messages herein before installing, operating or servicing this water heater.

Failure to follow these instructions and safety messages could result in death or serious injury.

This manual must remain with the water heater.

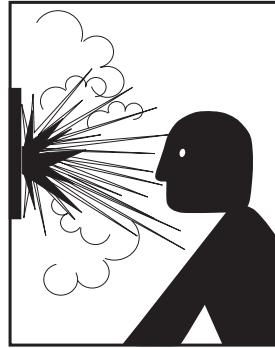

⚠️ WARNING

Explosion Hazard

- Overheated water can cause water tank explosion.
- Properly sized temperature and pressure relief valve must be installed in the opening provided.

⚠️ DANGER

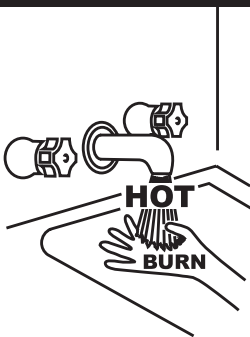

Water temperature over 125°F (52°C) can cause severe burns instantly resulting in severe injury or death.

Children, the elderly and the physically or mentally disabled are at highest risk for scald injury.

Feel water before bathing or showering.

Temperature limiting devices such as mixing valves must be installed when required by codes and to ensure safe temperatures at fixtures.

CAUTION

Improper installation, use and service may result in property damage.

- Do not operate water heater if any part has been exposed to flooding or water damage.
- Inspect anode rods regularly, replace if damaged.
- Install in location with drainage.
- Fill tank with water before operation.
- Properly sized thermal expansion tanks are required on all closed water systems.

Refer to this manual for installation and service.

Verify the power to the water heater is turned off before performing any service procedures.

GENERAL SAFETY INFORMATION

PRECAUTIONS

DO NOT USE THIS WATER HEATER IF ANY PART HAS BEEN EXPOSED TO FLOODING OR WATER DAMAGE. Immediately call a qualified service technician to inspect the water heater and to make a determination on what steps should be taken next.

If the unit is exposed to the following, do not operate heater until all corrective steps have been made by a qualified service technician.

1. External fire.
2. Damage.
3. Firing without water.

GROUNDING INSTRUCTIONS

This water heater must be grounded in accordance with the National Electrical Code and/or local codes. These must be followed in all cases.

This water heater must be connected to a grounded, permanent wiring system; or an equipment grounding conductor must be run with the circuit conductors and connected to the equipment grounding terminal or lead on the water heater, see Figures 20 and 21.

HYDROGEN GAS FLAMMABLE

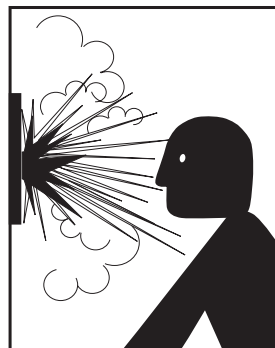

⚠️ WARNING

Explosion Hazard

- Flammable hydrogen gases may be present.
- Keep all ignition sources away from faucet when turning on hot water.

Hydrogen gas can be produced in a hot water system served by this water heater that has not been used for a long period of time (generally two weeks or more). Hydrogen gas is extremely flammable. To reduce the risk of injury under these conditions, it is recommended that a hot water faucet served by this water heater be opened for several minutes before using any electrical appliance connected to the hot water system. If hydrogen is present there will probably be an unusual sound such as air escaping through the pipe as the water begins to flow. THERE SHOULD BE NO SMOKING OR OPEN FLAME NEAR THE FAUCET AT THE TIME IT IS OPEN.

INTRODUCTION

Thank You for purchasing this water heater. Properly installed and maintained, it should give you years of trouble free service.

ABBREVIATIONS USED

Abbreviations found in this Instruction Manual include :

- ANSI - American National Standards Institute
- ASME - American Society of Mechanical Engineers
- AHRI - Air-Conditioning, Heating and Refrigeration Institute
- NEC - National Electrical Code
- NFPA - National Fire Protection Association
- UL - Underwriters Laboratory
- CSA - Canadian Standards Association

QUALIFICATIONS

QUALIFIED INSTALLER OR SERVICE AGENCY

Installation and service of this water heater requires ability equivalent to that of a Qualified Agency (as defined by ANSI below) in the field involved. Installation skills such as plumbing, air supply, venting, gas supply and electrical supply are required in addition to electrical testing skills when performing service.

ANSI Z223.1 2006 Sec. 3.3.83: “Qualified Agency” - “Any individual, firm, corporation or company that either in person or through a representative is engaged in and is responsible for (a) the installation, testing or replacement of gas piping or (b) the connection, installation, testing, repair or servicing of appliances and equipment; that is experienced in such work; that is familiar with all precautions required; and that has complied with all the requirements of the authority having jurisdiction.”

If you are not qualified (as defined by ANSI above) and licensed or certified as required by the authority having jurisdiction to perform a given task do not attempt to perform any of the procedures described in this manual. If you do not understand the instructions given in this manual do not attempt to perform any procedures outlined in this manual.

START UP REQUIREMENTS

This product requires a formal Start-Up by an authorized service/

start-up provider that has been approved by the manufacturer for this specific product. Call 1-800-527-1953 to locate the nearest authorized start-up provider and arrange a factory start-up. Please provide as much notice as possible, preferably 2 weeks. Please have the model and serial number ready when you call.

This start-up is required to activate the warranty and ensure safe, efficient operation.

Warranty on this product is limited and could be void in the event the unit is not installed per the instructions in this manual and/or not started up by an authorized factory trained service/start-up provider.

PREPARING FOR THE INSTALLATION

1. Read the “General Safety” section, page 4-5 of this manual first and then the entire manual carefully. If you don't follow the safety rules, the water heater will not operate properly. It could cause DEATH, SERIOUS BODILY INJURY AND/OR PROPERTY DAMAGE.

This manual contains instructions for the installation, operation, and maintenance of the gas-fired water heater. It also contains warnings throughout the manual that you must read and be aware of. All warnings and all instructions are essential to the proper operation of the water heater and your safety. Since we cannot put everything on the first few pages, READ THE ENTIRE MANUAL BEFORE ATTEMPTING TO INSTALL OR OPERATE THE WATER HEATER.

2. The installation must conform with these instructions and the local code authority having jurisdiction. In the absence of local codes, the installation must comply with the current editions of the National Fuel Gas Code, ANSI Z223.1/NFPA 54 or CAN/CSA-B149.1 the Natural Gas and Propane Installation Code. All documents are available from the Canadian Standards Association, 8501 East Pleasant Valley Road, Cleveland, OH 44131. NFPA documents are also available from the National Fire Protection Association, 1 Batterymarch Park, Quincy, MA 02269.
3. If after reading this manual you have any questions or do not understand any portion of the instructions, call the local gas utility or the manufacturer whose name appears on the rating plate.
4. Carefully plan the place where you are going to put the water heater. Correct combustion, vent action, and vent pipe installation are very important in preventing death from possible carbon monoxide poisoning and fires.

Examine the location to ensure the water heater complies with the “Locating the New Water Heater” section in this manual.

5. For California installation this water heater must be braced, anchored, or strapped to avoid falling or moving during an earthquake. See instructions for correct installation procedures. Instructions may be obtained from California Office of the State Architect, 400 P Street, Sacramento, CA 95814.
6. Massachusetts Code requires this water heater to be installed in accordance with Massachusetts 248-CMR 2.00: State Plumbing Code and 248-CMR 5.00.

FEATURES AND COMPONENTS

HIGH LIMIT SWITCH

The dual bulb controller (fig. 1) contains the high limit (energy cutoff) sensor. The high limit switch interrupts main burner gas flow should the water temperature reach 205°F (96°C).

In the event of high limit switch operation, the appliance cannot be restarted unless the water temperature is reduced by at least 20°F (11°C) and the high limit reset button on front of limit control (fig. 1) is depressed.

Continued manual resetting of high limit control, preceded by higher than usual water temperature is evidence of high limit switch operation. The following is a possible reason for high limit switch operation:

- A malfunction in the thermostatic controls would allow the gas control valve to remain open causing water temperature to exceed the thermostat setting. The water temperature would continue to rise until high limit switch operation.

Contact your dealer or service agent if continued high limit switch operation occurs.

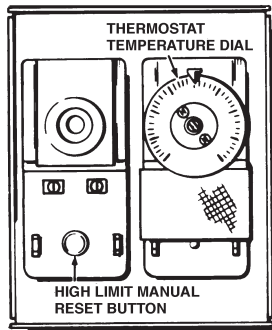

DIGITAL THERMOSTAT

FIGURE 1.

ELECTRONIC IGNITION CONTROL

Each heater is equipped with a Honeywell ignition module. The Direct Spark Ignition Control Module controls the ignition sequence and gas control operation of the water heater.

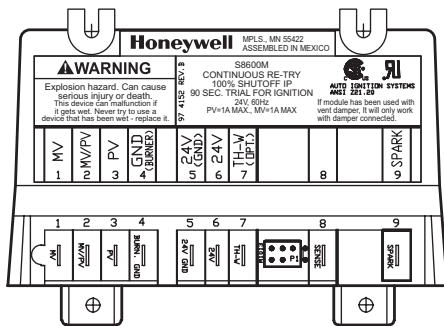

IGNITION MODULE

FIGURE 2.

BAROMETRIC DRAFT CONTROL

The heater is equipped with a double acting barometric draft control. This control assembly is factory adjusted to automatically regulate the chimney draft imposed on the unit.

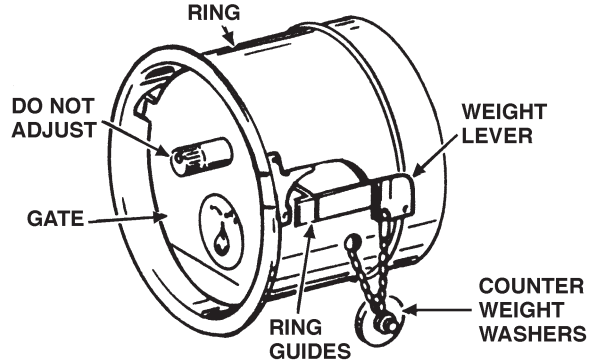

BAROMETRIC DRAFT CONTROL

FIGURE 3.

UNCRATING

Uncrate the heater by removing the outside mat and top locator. The shipping pallet must be removed from the unit. It may be possible to simply unbolt the base from the pallet and, with the help of 2 or more persons, work the unit off the pallet. Some units will be too heavy and will require the use of jacks or lifting equipment to safely remove the pallet and move the unit into position. Be careful when moving this heater. It will tip over easily.

The heater is shipped with a draft control. The draft control is shipped in a separate carton. It should be installed as received without any alterations.

Discard the shipping crate and packaging cartons in an appropriate manner.

INSTALLATION CONSIDERATIONS

ROUGH IN DIMENSIONS

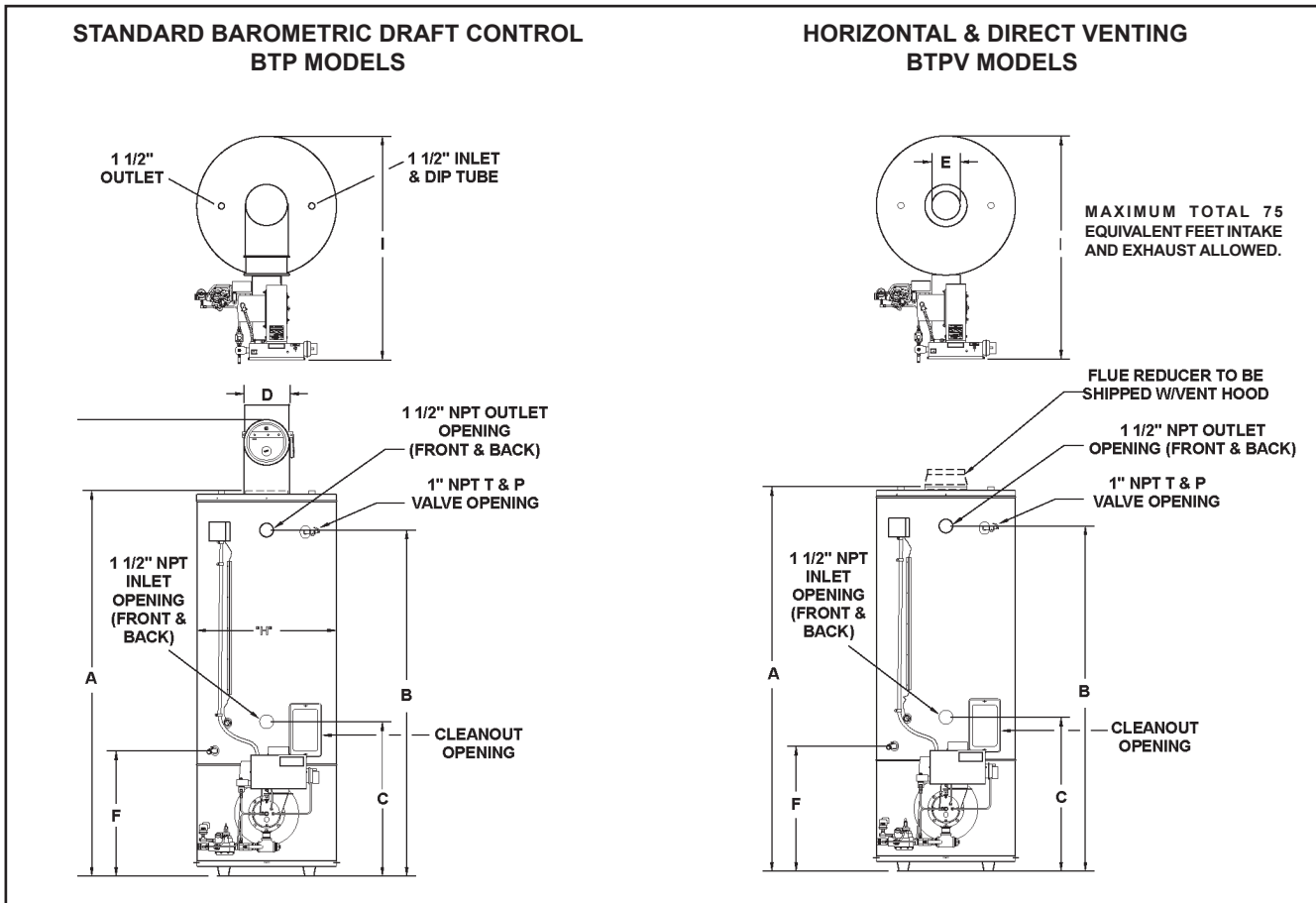

FIGURE 4.

TABLE 1 . MODELS BTP(V)-540(A) THROUGH BTP(V)-740(A)

Models	A	B	C	D	E	F	G	H	I	Gas Conn.	Approx. Ship. Wt.
BTP(V)-540A	80 3/4	73	32 1/4	9	6	26 1/2	93	29 1/2	48 1/2	1*	950
	2,051	1,854	819	229	152	673	2,362	749	1,232	25.4	431 kg
BTP(V)-650A	80 3/4	73	32 1/4	9	8	26 1/2	93	29 1/2	48 1/2	1*	950
	2,051	1,854	819	229	203	673	2,362	749	1,232	25.4	431 kg
BTP(V)-740A	80 3/4	73	32 1/4	9	8	26 1/2	93	29 1/2	48 1/2	1*	950
	2,051	1,854	819	229	203	673	2,362	749	1,232	25.4	431 kg

*Minimum gas supply pipe is 1 1/4", reference Table 11 for gas supply pipe size.

INSTALLATION CONSIDERATIONS

TABLE 2. HEATER PERFORMANCE DATA BTP MODELS

Models	Storage Capacity U.S. Gals. (Litres)	Input Rating BTU/HR. Nat.	Recovery Rating GPH 100°F Rise*	Recovery Rating GPH 140°F Rise*	Current Draw 120V GOHz 1 Phase
BTP(V)-540A	85 (261)	540,000	523.6	374	6.0 Amps
BTP(V)-650A	85 (261)	650,000	630	450	
BTP(V)-740A	85 (261)	740,000	718	512	

Models with letter "A" following the model number have the optional ASME tank construction.

*Based on 80% thermal efficiency.

NOTE: To compensate for the effects of high altitude areas above 2000 feet, recovery ratings should be reduced approximately 4% for every 1000 feet above sea level.

TABLE 3. GAS AND ELECTRICAL CHARACTERISTICS

Model	Type of Gas	Gas Supply Pressure		Gas Manifold Pressure	Volts/Hz	Amperes
		Minimum	Maximum			
All Models	Natural	8.0" W.C. (2.0 kPa)	14" W.C. (3.48 kPa)	4.7" W.C. (1.18 kPa)	120/60	<5

* All models are available in Natural Gas only.

Model	BTP(V)-540A	BTP(V)-650A	BTP(V)-750A
Min. Dynamic Gas Supply Line Pressure	8" w.c. (2 kPa) When heater is ON		
Max. Static Gas Supply Line Pressure	14" w.c. (3.5 kPa) When heater is OFF		
Gas Manifold Pressure	4.7" w.c.(1.1 kPa) (Ref.)*	4.7" w.c. 1.1 kPa) (Ref.)*	4.7" w.c.(1.1 kPa) (Ref.)*
Gas Orifice Size	1/2"	11/16"	N/A
Air Inlet Damper Dial Setting	3**	4.5**	5.6**
Combustion Emissions Range	Flue Gas O ₂ : 5 - 6.5%** (or CO ₂ reading 8-9%)		

* **Note:** Flue gas excess O₂ below 3% may cause combustion chamber premature failure; flue gas excess O₂ above 7% may cause rough operation or incomplete combustion. Final manifold pressure settings should be based on flue O₂/CO₂ reading!

** **Note:** Air inlet damper setting needs to be adjusted at field for direct vent and/or high elevation installations.

INSTALLATION CONSIDERATIONS

LOCATING THE WATER HEATER

CAUTION

Property Damage Hazard

- All water heaters eventually leak.
- Do not install without adequate drainage.

When installing the heater, consideration must be given to proper location. Location selected should be as close to the stack or chimney as practicable, with adequate air supply and as centralized with the piping system as possible.

WARNING

Fire or Explosion Hazard

- Do not store or use gasoline or other flammable vapors and liquids in the vicinity of this or any other appliance.
- Avoid all ignition sources if you smell gas.
- Do not expose water heater controls to excessive gas pressure.
- Use only the gas shown on the water heater rating label.
- Maintain required clearances to combustibles.
- Keep ignition sources away from faucets after extended periods of non-use.



Read instruction manual before installing, using or servicing water heater.



There is a risk in using fuel burning appliances such as gas water heaters in rooms, garages or other areas where gasoline, other flammable liquids or engine driven equipment or vehicles are stored, operated or repaired. Flammable vapors are heavy and travel along the floor and may be ignited by the heater's igniter or main burner flames causing fire or explosion. Some local codes permit operation of gas appliances in such areas if they are installed 18" (457.2 mm) or more above the floor. This may reduce the risk if location in such an area cannot be avoided.

Do not install this water heater directly on a carpeted floor. A fire hazard may result. Instead the water heater must be placed on a metal or wood panel extending beyond the full width and depth by at least 3" (76.2 mm) in any direction. If the heater is installed in a carpeted alcove, the entire floor shall be covered by the panel. Also, see the DRAINING requirements in MAINTENANCE Section.

The heater shall be located or protected so it is not subject to physical damage by a moving vehicle.

Flammable items, pressurized containers or any other potential fire hazardous articles must never be placed on or adjacent to the heater. Open containers or flammable material should not be stored or used in the same room with the heater.

The heater must not be located in an area where it will be subject to freezing.

Locate it near a floor drain. The heater should be located in an area where leakage from heater or connections will not result in damage to adjacent area or to lower floors of the structure.

When such locations cannot be avoided, a suitable metal drain pan should be installed under heater. Such pans should be fabricated with sides at least 2" (50.8 mm) deep, with length and width at least 2" (50.8 mm) greater than diameter of heater and must be piped to an adequate drain. Pan must not restrict combustion air flow.

CLEARANCES

These heaters are designed for installation on non-combustible flooring in an alcove with clearances to combustible construction of 6" (152.4 mm) from the sides and rear, 24" (610 mm) from the top with a 6" (152.4 mm) minimum between vent pipe and ceiling.

Minimum clearance from flue pipe to combustible material is 6" (152.4 mm), see Figures 6. & 7.

Units which are to be installed on combustible flooring must be supported by a full layer of hollow concrete blocks, from 8" to 12" thick and extending 12" (minimum) beyond the heater in all directions. The concrete blocks must provide an unbroken concrete surface under the heater with the hollows running continuously and horizontally. A 3/16 inch steel plate must cover the concrete blocks. See Figure 5.

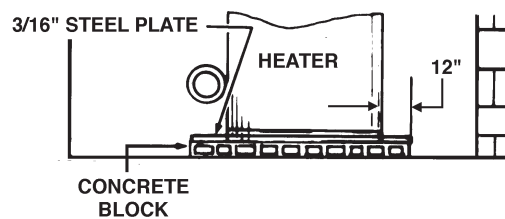

PROPER INSTALLATION ON COMBUSTIBLE FLOORING
FIGURE 5.

In all installations the minimum combustible clearances from barometric draft control surface or vent piping shall be 6" (152 mm). Vent piping passing through a combustible wall or ceiling must be a continuous run (no joints) and retain 6" (152 mm) clearance unless an approved reducing thimble is used.

A service clearance of 30" (762 mm) should be maintained from serviceable parts, such as relief valves, baffles, thermostats, cleanout openings or drain valves.

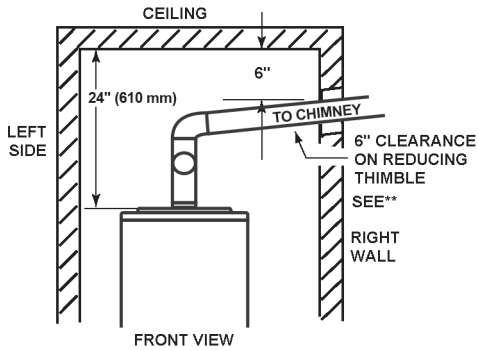

NOTES:
 * INCLUDES 6" FROM VENTING AND FLUE BAFFLE SERVICE CLEARANCE.
 ** ALL HORIZONTAL VENT PIPING SHALL HAVE A RISE OF 1/4" PER FOOT MINIMUM, SEE "VENTING".

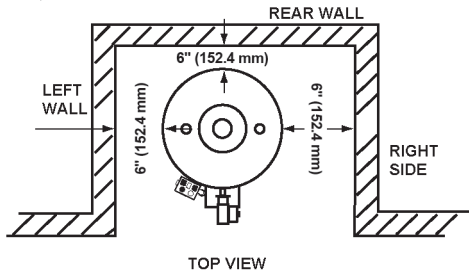

ILLUSTRATION OF MINIMUM COMBUSTIBLE CLEARANCES IN AN ALCOVE

FIGURE 6. & FIGURE 7.

INSULATION BLANKET

WARNING

Breathing Hazard - Carbon Monoxide Gas

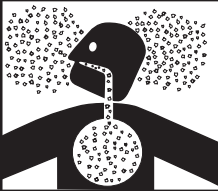

- Do not obstruct water heater air intake with insulating blanket.
- Gas and carbon monoxide detectors are available.
- Install water heater in accordance with the instruction manual.

Breathing carbon monoxide can cause brain damage or death. Always read and understand instruction manual.

Insulation blankets are available to the general public for external use on gas water heaters but are not necessary with these products. The purpose of an insulation blanket is to reduce the standby heat loss encountered with storage tank heaters. The water heaters covered by this manual meet or exceed the Energy Policy Act standards with respect to insulation and standby heat loss requirements, making an insulation blanket unnecessary.

Should you choose to apply an insulation blanket to this heater, you should follow these instructions. See the Features and Components section of this manual for identification of components mentioned below. Failure to follow these instructions can restrict the air flow required for proper combustion, potentially resulting in fire, asphyxiation, serious personal injury or death.

- **DO NOT** apply insulation to the top of the water heater, as this will interfere with safe operation of the draft control.
- **DO NOT** cover the gas control valve, thermostat or the Temperature-Pressure Relief Valve.
- **DO NOT** allow insulation to come within 2" (5 cm) of the burners, to prevent blockage of combustion air flow to the burners.

- **DO NOT** cover the instruction manual. Keep it on the side of the water heater or nearby for future reference.
- **DO** obtain new warning and instruction labels from the manufacturer for placement on the blanket directly over the existing labels.
- **DO** inspect the insulation blanket frequently to make certain it does not sag, thereby obstructing combustion air flow.

HARD WATER

Where hard water conditions exist, water softening or the threshold type of water treatment is recommended. This will protect the dishwashers, coffee urns, water heaters, water piping and other equipment.

See the Maintenance Section in this manual for sediment and lime scale removal procedures.

CIRCULATION PUMPS

A circulating pump is used when a system requires a circulating loop or there is a storage tank used in conjunction with the water heater. See Water Piping Diagrams in this manual for installation location of circulating pumps.

See the Circulation Pump Wiring Diagrams in this manual for electrical hookup information. Install in accordance with the current edition of the National Electrical Code, NFPA 70 or the Canadian Electrical Code, CSA C22.1.

All-bronze circulating pumps are recommended for used with commercial water heaters.

Some circulating pumps are manufactured with sealed bearings and do not require further lubrication. Some circulating pumps must be periodically oiled. Refer to the pump manufacturer's instructions for lubrication requirements.

CIRCULATING PUMP WIRING DIAGRAM STORAGE TANK OR BUILDING RECIRCULATION

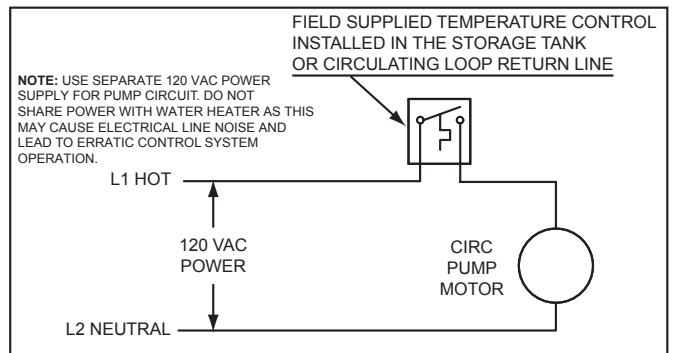

FIGURE 8.

CIRCULATING PUMP WIRING DIAGRAM DISHWASHER LOOP WITH TOGGLE SWITCH

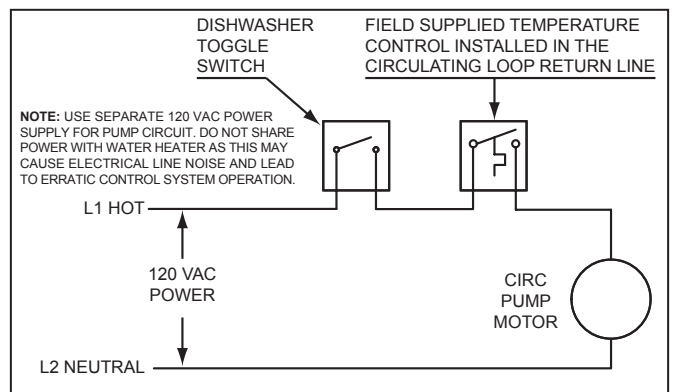



FIGURE 9.

HIGH ALTITUDE INSTALLATIONS

	⚠️ WARNING
	Fire and Explosion Hazard
	<ul style="list-style-type: none">• Under no circumstances should the input exceed the rate shown on the water heater's rating label.• Overfiring could result in fire or explosion.• Gas and carbon monoxide detectors are available.

Your A.O. Smith water heater has been designed to operate at altitudes below 2000 Ft. (609.6 m). For appliance installation locations with elevations above 2000 Ft. (609.6 m), special considerations need to be taken. Adjustments for high altitude can only be made by an A.O. Smith authorized BTP Start-up Agent. To ensure your water heater operates properly at high elevation, an A.O. Smith authorized BTP Start-up Agent will readjust the air-intake damper setting and the gas manifold pressure (if required).

NOTE: Some gas utility companies derate the heating value of the supplied gas at high elevation. Your authorized start-up agent must adjust for actual heating value of the gas at the time of start up.

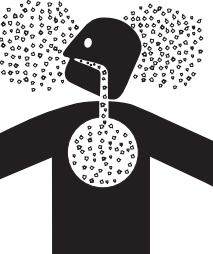
	⚠️ WARNING
	Breathing Hazard - Carbon Monoxide Gas
	<ul style="list-style-type: none">• Under no circumstances should the input exceed the rate shown on the water heater's rating label.• Overfiring could result in damage to the water heater and sooting.• Gas and carbon monoxide detectors are available.
Breathing carbon monoxide can cause brain damage or death. Always read and understand instruction manual.	

Printed on 2/9/2021 9:24 AM CT

INSTALLATION REQUIREMENTS

GAS SUPPLY SYSTEMS

Low pressure building gas supply systems are defined as those systems that cannot under any circumstances exceed 14" W.C. (1/2 PSI Gauge). These systems do not require pressure regulation. Measurements should be taken to insure that gas pressures are stable and fall within the requirements stated on the water heater rating plate. Readings should be taken with all gas burning equipment off (static pressure) and with all gas burning equipment running at maximum rate (dynamic pressure). The gas supply pressure must be stable within 1.5" W.C. from static to dynamic pressure to provide good performance. Pressure drops that exceed 1.5" W.C. may cause rough starting, noisy combustion or nuisance outages. Increases or spikes in static pressure during off cycles may cause failure to ignite or in severe cases damage to appliance gas valves. If your low pressure system does NOT meet these requirements, the installer is responsible for the corrections.

High Pressure building supply systems use pressures that exceed 14" W.C. (1/2 PSI Gauge). These systems must use field supplied regulators to lower the gas pressure to less than 14" W.C. (1/2 PSI Gauge). Water heaters require gas regulators that are properly sized for the water heater input and deliver the rating plate specified pressures. Gas supply systems where pressure exceeds 5 PSI often require multiple regulators to achieve desired pressures. Systems in excess of 5 PSI building pressure should be designed by gas delivery professionals for best performance. Water heaters connected to gas supply systems that exceed 14" W.C. (1/2 PSI Gauge) at any time must be equipped with a gas supply regulator.

All models require a minimum gas supply pressure of 8.0" W.C. for natural gas and propane gas. The minimum supply pressure is measured while gas is flowing (dynamic pressure). The supply pressure should never fall below 8.0" W.C. for natural gas. The supply pressure should be measured with all gas fired appliances connected to the common main firing at full capacity. If the supply pressure drops more than 1.5" W.C. as gas begins to flow to the water heater then the supply gas system including the gas line and/or the gas regulator may be restricted or undersized. See Supply Gas Regulator section and Gas Piping section of this manual. The gas valve on all models has a maximum gas supply pressure limit of 14" W.C. The maximum supply pressure is measured while gas is not flowing (static pressure).

SUPPLY GAS REGULATOR

The maximum allowable gas supply pressure for this water heater is 14" W.C. (3.48 kPa). Install a positive lock-up gas pressure regulator in the gas supply line if inlet gas pressure can exceed 14" W.C. (3.48 kPa) at any time. Regulators must be sized/used according to manufacturer's specifications.

If a positive lock-up regulator is required follow these instructions:

1. Positive lock-up gas pressure regulators must be rated at or above the input Btu/hr rating of the water heater they supply.
2. Positive lock-up gas pressure regulator(s) should be installed no closer than 3 equivalent feet (1 meter) and no farther than 8 equivalent feet (2.4 meters) from water heater's inlet gas connection.
3. After installing the positive lock-up gas pressure regulator(s), an initial nominal supply pressure setting of 8.0" W.C. (2 kPa) while water heater is operating is recommended and will generally provide good water heater operation. Some additional adjustment maybe required later to maintain a steady gas supply pressure.

4. When installing multiple water heaters in the same gas supply system it is recommended that individual positive lock-up gas pressure regulators be installed at each unit.

POWER SUPPLY

The water heaters covered in this manual require a 120 VAC, 1Ø (single phase), 60Hz, 15 amp power supply and must also be electrically grounded in accordance with local codes or, in the absence of local codes, with the National Electrical Code, ANSI/NFPA 70 or the Canadian Electrical Code, CSA C22.1.

WATER TEMPERATURE CONTROL AND MIXING VALVES

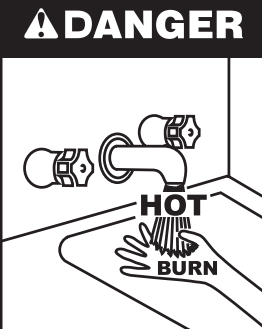

Water temperature over 125°F (52°C) can cause severe burns instantly resulting in severe injury or death.

Children, the elderly and the physically or mentally disabled are at highest risk for scald injury.

Feel water before bathing or showering.

Temperature limiting devices such as mixing valves must be installed when required by codes and to ensure safe temperatures at fixtures.

Water heated to a temperature which will satisfy clothes washing, dish washing, and other sanitizing needs can scald and cause permanent injury upon contact. Short repeated heating cycles caused by small hot water uses can cause temperatures at the point of use to exceed the water heater's temperature setting by up to 20°F (11°C).

Some people are more likely to be permanently injured by hot water than others. These include the elderly, children, the infirm and the physically/mentally disabled. Table 4 shows approximate time-to-burn relationship for normal adult skin. If anyone using hot water provided by the water heater being installed fits into one of these groups or if there is a local code or state law requiring a certain water temperature at the point of use, then special precautions must be taken.

In addition to using the lowest possible temperature setting that satisfies the demand of the application a Mixing Valve should be installed at the water heater (see Figure 10) or at the hot water taps to further reduce system water temperature.

Mixing valves are available at plumbing supply stores. Consult a Qualified Installer or Service Agency. Follow mixing valve manufacturer's instructions for installation of the valves.

TABLE 4.

Water Temperature °F	Time for 1st Degree Burn (Less Severe Burns)	Time for Permanent Burns 2nd & 3rd Degree (Most Severe Burns)
110	(normal shower temp.)	
116	(pain threshold)	
116	35 minutes	45 minutes
122	1 minute	5 minutes
131	5 seconds	25 seconds
140	2 seconds	5 seconds
149	1 second	2 seconds
154	instantaneous	1 second

(U.S. Government Memorandum, C.P.S.C., Peter L. Armstrong, Sept. 15, 1978)

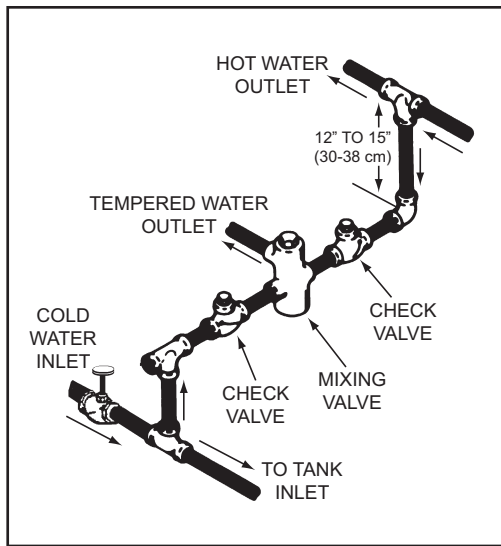

FIGURE 10.

DISHWASHING MACHINES

All dishwashing machines meeting the National Sanitation Foundation requirements are designed to operate with water flow pressures between 15 and 25 pounds per square inch (103 kPa and 173 kPa). Flow pressures above 25 pounds per square inch (173 kPa), or below 15 pounds per square inch (103 kPa), will result in improperly sanitized dishes. Where pressures are high, a water pressure reducing or flow regulating control valve should be used in the 180°F (82°C) line to the dishwashing machine and should be adjusted to deliver water pressure between these limits.

The National Sanitation Foundation also recommends circulation of 180°F (82°C) water. The circulation flow rate should be just enough to provide 180°F (82°C) water at the point of take-off to the dishwashing machine.

Adjust flow by throttling a full port ball valve installed in the circulating line on the outlet side of the pump. Never throttle flow on the suction side of a pump. See Water Piping Diagrams in this manual.

CLOSED WATER SYSTEMS

Water supply systems may, because of code requirements or such conditions as high line pressure, among others, have installed devices such as pressure reducing valves, check valves, and back flow preventers. Devices such as these cause the water system to be a closed system.

THERMAL EXPANSION

As water is heated, it expands (thermal expansion). In a closed system the volume of water will grow when it is heated. As the volume of water grows there will be a corresponding increase in water pressure due to thermal expansion. Thermal expansion can cause premature tank failure (leakage). This type of failure is not covered under the limited warranty. Thermal expansion can also cause intermittent Temperature-Pressure Relief Valve operation: water discharged from the valve due to excessive pressure build up. This condition is not covered under the limited warranty. The Temperature-Pressure Relief Valve is not intended for the constant relief of thermal expansion.

A properly sized thermal expansion tank must be installed on all closed systems to control the harmful effects of thermal expansion. Contact a local plumbing service technician to have a thermal expansion tank installed.

See Water Line Connections on page 24 and the Water Piping Diagrams beginning on page 41.

TEMPERATURE-PRESSURE RELIEF VALVE

	<h1>WARNING</h1>
	<h3>Explosion Hazard</h3>
	<ul style="list-style-type: none"> • Temperature-Pressure Relief Valve must comply with ANSI Z21.22- CSA 4.4 and ASME code. • Properly sized temperature-pressure relief valve must be installed in opening provided. • Can result in overheating and excessive tank pressure. • Can cause serious injury or death.

This water heater is provided with a properly rated/sized and certified combination Temperature-Pressure Relief Valve (T&P valve) by the manufacturer. The valve is certified by a nationally recognized testing laboratory that maintains periodic inspection of production of listed equipment of materials as meeting the requirements for Pressure Relief Valves for Hot Water Supply Systems, ANSI Z21.22 • CSA 4.4, and the code requirements of ASME.

If replaced, the new T&P valve must meet the requirements of local codes, but not less than a combination Temperature-Pressure Relief Valve rated/sized and certified as indicated in the above paragraph. The new valve must be marked with a maximum set pressure not to exceed the marked hydrostatic working pressure of the water heater (150 psi = 1,035 kPa) and a discharge capacity not less than the water heater Btu/hr or kW input rate as shown on the water heater's model rating label.

NOTE: In addition to the factory installed Temperature-Pressure Relief Valve on the water heater, each remote storage tank that may be installed and piped to a water heating appliance must also have its own properly sized, rated and approved Temperature-Pressure Relief Valve installed. Call the toll free technical support phone number listed on the back cover of this manual for technical assistance in sizing a Temperature-Pressure Relief Valve for remote storage tanks.

For safe operation of the water heater, the Temperature-Pressure Relief Valve must not be removed from its designated opening nor plugged. The Temperature-Pressure Relief Valve must be installed directly into the fitting of the water heater designed for the pressure relief valve. Install discharge piping so that any discharge will exit the pipe within 6 inches (15.2 cm) above an adequate floor drain, or external to the building. In cold climates it is recommended that it be terminated at an adequate drain inside the building. Be certain that no contact is made with any live electrical part. The discharge opening must not be blocked or reduced in size under any circumstances. Excessive length, over 30 feet (9.14 m), or use of more than four elbows can cause restriction and reduce the discharge capacity of the valve.

No valve or other obstruction is to be placed between the Temperature-Pressure Relief Valve and the tank. Do not connect discharge piping directly to the drain unless a 6" (15.2 cm) air gap is provided. To prevent bodily injury, hazard to life, or property damage, the relief valve must be allowed to discharge water in adequate quantities should circumstances demand. If the discharge pipe is not connected to a drain or other suitable means, the water flow may cause property damage.

CAUTION
Water Damage Hazard
<ul style="list-style-type: none"> • Temperature-Pressure Relief Valve discharge pipe must terminate at adequate drain.

T&P Valve Discharge Pipe Requirements:

- Shall not be smaller in size than the outlet pipe size of the valve, or have any reducing couplings or other restrictions.
- Shall not be plugged or blocked.
- Shall not be exposed to freezing temperatures.
- Shall be of material listed for hot water distribution.
- Shall be installed so as to allow complete drainage of both the Temperature-Pressure Relief Valve and the discharge pipe.
- Must terminate a maximum of six inches above a floor drain or external to the building. In cold climates, it is recommended that the discharge pipe be terminated at an adequate drain inside the building.
- Shall not have any valve or other obstruction between the pressure relief valve and the drain.

⚠ DANGER	<ul style="list-style-type: none"> • Burn hazard. • Hot water discharge. • Keep clear of Temperature-Pressure Relief Valve discharge outlet.

The Temperature-Pressure Relief Valve must be manually operated at least twice a year. Caution should be taken to ensure that (1) no one is in front of or around the outlet of the Temperature-Pressure Relief Valve discharge line, and (2) the water manually discharged will not cause any bodily injury or property damage because the water may be extremely hot. If after manually operating the valve, it fails to completely reset and continues to release water, immediately close the cold water inlet to the water heater, follow the draining instructions in this manual, and replace the Temperature-Pressure Relief Valve with a properly rated/sized new one.

NOTE: The purpose of a Temperature-Pressure Relief Valve is to prevent excessive temperatures and pressures in the storage tank. The T&P valve is not intended for the constant relief of thermal expansion. A properly sized thermal expansion tank must be installed on all closed systems to control thermal expansion, see Closed Water Systems and Thermal Expansion on page 14.

If you do not understand these instructions or have any questions regarding the Temperature-Pressure Relief Valve call the toll free number listed on the back cover of this manual for technical assistance.

CONTAMINATED AIR

⚠ WARNING	
Breathing Hazard - Carbon Monoxide Gas	
	<ul style="list-style-type: none"> • Install water heater in accordance with the Instruction Manual and NFPA 54 or CAN/CSA-B149.1. • To avoid injury, combustion and ventilation air must be taken from outdoors. • Do not place chemical vapor emitting products near water heater.
Breathing carbon monoxide can cause brain damage or death. Always read and understand instruction manual.	

Corrosion of the flue ways and vent system may occur if air for combustion contains certain chemical vapors. Such corrosion may result in failure and risk of asphyxiation.

Combustion air that is contaminated can greatly diminish the life span of the water heater and water heater components such as hot surface igniters and burners. Propellants of aerosol sprays, beauty shop supplies, water softener chemicals and chemicals used in dry cleaning processes that are present in the combustion, ventilation or ambient air can cause such damage.

Do not store products of this sort near the water heater. Air which is brought in contact with the water heater should not contain any of these chemicals. If necessary, uncontaminated air should be obtained from remote or outdoor sources. The limited warranty is voided when failure of water heater is due to a corrosive atmosphere. (See limited warranty for complete terms and conditions).

AIR REQUIREMENTS

⚠ WARNING	
Breathing Hazard - Carbon Monoxide Gas	
	<ul style="list-style-type: none"> • Install water heater in accordance with the Instruction Manual and NFPA 54 or CAN/CSA-B149.1. • To avoid injury, combustion and ventilation air must be taken from outdoors. • Do not place chemical vapor emitting products near water heater.
Breathing carbon monoxide can cause brain damage or death. Always read and understand instruction manual.	

For safe operation an adequate supply of fresh uncontaminated air for combustion and ventilation must be provided.

An insufficient supply of air can cause recirculation of combustion products resulting in contamination that may be hazardous to life. Such a condition often will result in a yellow, luminous burner flame, causing sooting of the combustion chamber, burners and flue tubes and creates a risk of asphyxiation.

Do not install the water heater in a confined space unless an adequate supply of air for combustion and ventilation is brought in to that space using the methods described in the Confined Space section that follows.

Never obstruct the flow of ventilation air. If you have any doubts or questions at all, call your gas supplier. Failure to provide the proper amount of combustion air can result in a fire or explosion and cause property damage, serious bodily injury or death.

UNCONFINED SPACE

An Unconfined Space is one whose volume IS NOT LESS THAN 50 cubic feet per 1,000 Btu/hr (4.8 cubic meters per kW) of the total input rating of all appliances installed in the space. Rooms communicating directly with the space, in which the appliances are installed, through openings not furnished with doors, are considered a part of the unconfined space.

Makeup air requirements for the operation of exhaust fans, kitchen ventilation systems, clothes dryers and fireplaces shall also be considered in determining the adequacy of a space to provide combustion, ventilation and dilution air.

UNUSUALLY TIGHT CONSTRUCTION

In unconfined spaces in buildings, infiltration may be adequate to provide air for combustion, ventilation and dilution of flue gases. However, in buildings of unusually tight construction (for example, weather stripping, heavily insulated, caulked, vapor barrier, etc.) additional air must be provided using the methods described in the Confined Space section that follows.

CONFINED SPACE

A Confined Space is one whose volume is less than 50 cubic feet per 1,000 Btu/hr (4.8 cubic meters per kW) of the total input rating of all appliances installed in the space.

Openings must be installed to provide fresh air for combustion, ventilation and dilution in confined spaces. The required size for the openings is dependent on the method used to provide fresh air to the confined space and the total Btu/hr input rating of all appliances installed in the space.

DIRECT VENT APPLIANCES

Appliances installed in a Direct Vent configuration that derive all air for combustion from the outdoor atmosphere through sealed intake air piping are not factored in the total appliance input Btu/hr calculations used to determine the size of openings providing fresh air into confined spaces.

EXHAUST FANS

Where exhaust fans are installed, additional air shall be provided to replace the exhausted air. When an exhaust fan is installed in the same space with a water heater, sufficient openings to provide fresh air must be provided that accommodate the requirements for all appliances in the room and the exhaust fan. Undersized openings will cause air to be drawn into the room through the water heater's vent system causing poor combustion. Sooting, serious damage to the water heater and the risk of fire or explosion may result. It can also create a risk of asphyxiation.

LOUVERS AND GRILLES

The free areas of the fresh air openings in the instructions that follow do not take in to account the presence of louvers, grilles or screens in the openings.

The required size of openings for combustion, ventilation and dilution air shall be based on the "net free area" of each opening. Where the free area through a design of louver or grille or screen is known, it shall be used in calculating the size of opening required to provide the free area specified. Where the louver and grille design and free area are not known, it shall be assumed that wood louvers will have 25% free area and metal louvers and grilles will have 75% free area. Non motorized louvers and grilles shall be fixed in the open position.

VENTING INSTALLATION

FRESH AIR OPENINGS FOR CONFINED SPACES

The following instructions shall be used to calculate the size, number and placement of openings providing fresh air for combustion, ventilation and dilution in confined spaces. The illustrations shown in this section of the manual are a reference for the openings that provide fresh air into confined spaces only. DO NOT refer to these illustrations for the purpose of vent installation. See Venting Installation on pages 17 through 23 for complete venting installation instructions.

OUTDOOR AIR THROUGH TWO OPENINGS

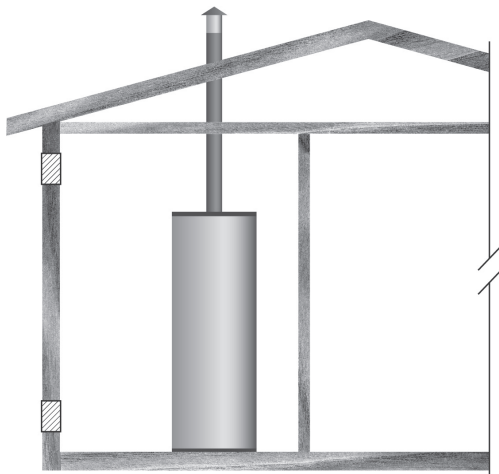

FIGURE 11.

The confined space shall be provided with two permanent openings, one commencing within 12 inches (300 mm) of the top

and one commencing within 12 inches (300 mm) of the bottom of the enclosure. The openings shall communicate directly with the outdoors. See Figure 11.

Each opening shall have a minimum free area of 1 square inch per 4,000 Btu/hr (550 mm² per kW) of the aggregate input rating of all appliances installed in the enclosure. Each opening shall not be less than 100 square inches (645 cm²).

OUTDOOR AIR THROUGH ONE OPENING

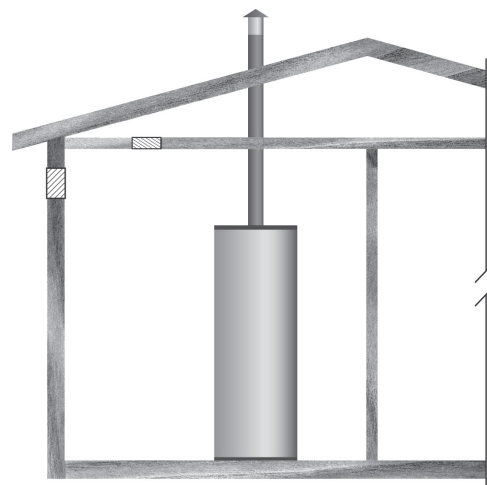

FIGURE 12.

Alternatively a single permanent opening, commencing within 12 inches (300 mm) of the top of the enclosure, shall be provided. See Figure 11. The water heater shall have clearances of at least 1 inch (25 mm) from the sides and back and 6 inches (150 mm) from the front of the water heater. The opening shall directly communicate with the outdoors or shall communicate through a

vertical or horizontal duct to the outdoors or spaces that freely communicate with the outdoors and shall have a minimum free area of the following:

1. 1 square inch per 3000 Btu/hr (733 mm² per kW) of the total input rating of all appliances located in the enclosure, and
2. Not less than the sum of the areas of all vent connectors in the space.

OUTDOOR AIR THROUGH TWO HORIZONTAL DUCTS

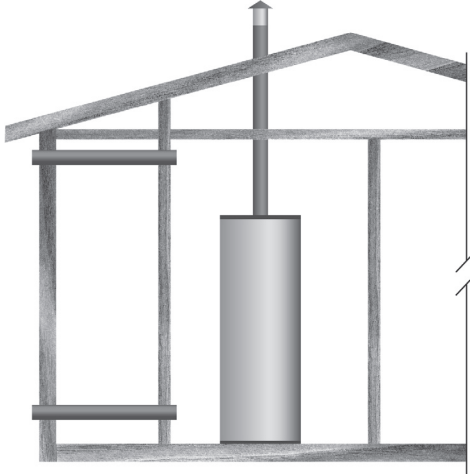

FIGURE 13.

The confined space shall be provided with two permanent horizontal ducts, one commencing within 12 inches (300 mm) of the top and one commencing within 12 inches (300 mm) of the bottom of the enclosure. The horizontal ducts shall communicate directly with the outdoors. See Figure 13.

Each duct opening shall have a minimum free area of 1 square inch per 2,000 Btu/hr (1100 mm² per kW) of the aggregate input rating of all appliances installed in the enclosure.

When ducts are used, they shall be of the same cross sectional area as the free area of the openings to which they connect. The minimum dimension of rectangular air ducts shall be not less than 3 inches.

OUTDOOR AIR THROUGH TWO VERTICAL DUCTS

The illustrations shown in this section of the manual are a reference for the openings that provide fresh air into confined spaces only.

Do not refer to these illustrations for the purpose of vent installation. See Venting Installation on pages 17-18 for complete venting installation instructions.

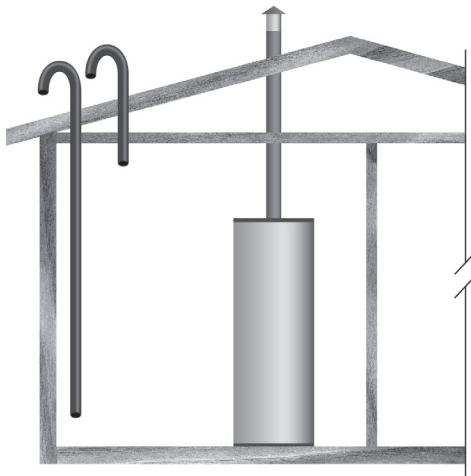

FIGURE 14.

The confined space shall be provided with two permanent vertical ducts, one commencing within 12 inches (300 mm) of the top and one commencing within 12 inches (300 mm) of the bottom of the enclosure. The vertical ducts shall communicate directly with the outdoors. See Figure 14.

Each duct opening shall have a minimum free area of 1 square inch per 4,000 Btu/hr (550 mm² per kW) of the aggregate input rating of all appliances installed in the enclosure.

When ducts are used, they shall be of the same cross sectional area as the free area of the openings to which they connect. The minimum dimension of rectangular air ducts shall be not less than 3" (76.2 mm).

AIR FROM OTHER INDOOR SPACES

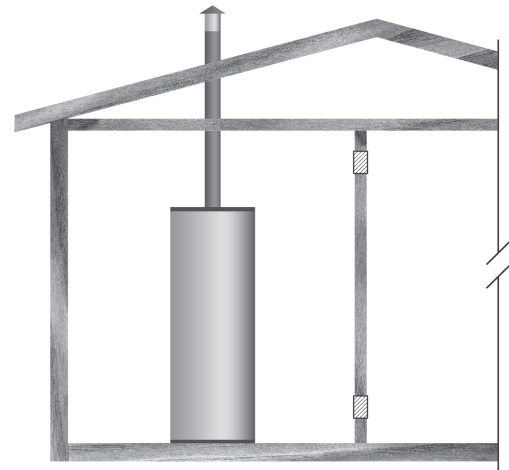

FIGURE 15.

The confined space shall be provided with two permanent openings, one commencing within 12 inches (300 mm) of the top and one commencing within 12 inches (300 mm) of the bottom of the enclosure. See Figure 15.

Each opening shall communicate directly with an additional room(s) of sufficient volume so that the combined volume of all spaces meets the criteria for an Unconfined Space.

Each opening shall have a minimum free area of 1 square inch per 1,000 Btu/hr (2200 mm² per kW) of the aggregate input rating of all appliances installed in the enclosure. Each opening shall not be less than 100 square inches (645 cm²).

VENTING

THE INSTRUCTIONS IN THIS SECTION ON VENTING MUST BE FOLLOWED TO AVOID CHOKED COMBUSTION OR RECIRCULATION OF FLUE GASES. SUCH CONDITIONS CAUSE SOOTING OR RISKS OF FIRE AND ASPHYXIATION.

Heater must be protected from freezing downdrafts.

Remove all soot or other obstructions from the chimney that will retard a free draft.

Water heaters covered by these instructions are Category 1, Natural Draft appliances. Type B venting is recommended with these heaters.

This water heater must be vented in compliance with all local codes, the current revision of the National Fuel Gas Code (ANSI-Z223.1) and with the Category I Natural Draft Venting Tables.

If any part of the vent system is exposed to ambient temperatures below 40°F (4.4°C) it must be insulated to prevent condensation.

- Do not connect the heater to a common vent or chimney with solid fuel burning equipment. This practice is prohibited by many local building codes as is the practice of venting gas fired equipment to the duct work of ventilation systems.

- Where a separate vent connection is not available and the vent pipe from the heater must be connected to a common vent with an oil burning furnace, the vent pipe should enter the smaller common vent or chimney at a point above the large vent pipe.

BAROMETRIC DRAFT CONTROL ASSEMBLY

A double-acting barometric draft control assembly is provided with each unit. The draft control assembly must be installed without alteration. This assembly is factory adjusted for horizontal application only and must be attached to the heater as shown in Figure 16. The outlet of the draft control assembly may be rotated to face in direction needed. The assembly must be fitted to the jacket cover such that it is plumb and level to the ground. Fasten the draft control assembly to the top cover using sheet metal screws at three locations, or more, as required.

Dampers or other obstructions must not be installed between the heater and the barometric draft control assembly.

Do not adjust settings on gate. Counterweight washers are factory adjusted and should result in breeching pressure measurements at the combustion test hole within the range shown in Table 3. See Figure 16.

NOTE: A negative draft 0.02" to 0.07" w.c. must be maintained in the vent piping. When installed, the damper gate must pivot freely in the ring guides. This gate will automatically adjust to regulate the chimney draft imposed on the heater.

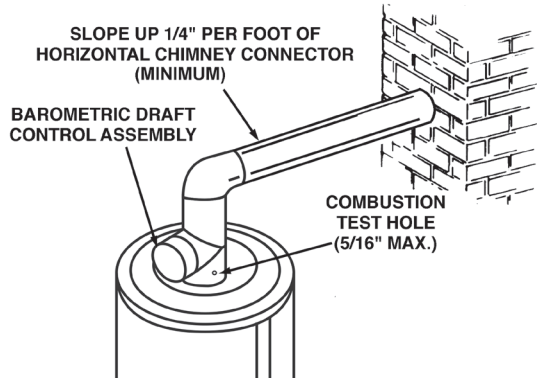

PROPER DRAFT CONTROLLER AND VENT PIPE INSTALLATION
FIGURE 16.

VENT CONNECTION

Vent connections must be made to an adequate stack or chimney. Refer to the National Fuel Gas Code (current edition) or to the vent pipe manufacturer's gas vent and chimney sizing table to properly design and size the venting system. Refer to Table 5 for the vent pipe size required for installation to the barometric draft control assembly outlet.

TABLE 5. BAROMETRIC DRAFT CONTROL ASSEMBLY OUTLET SIZE

Model	Flue Outlet
BTP-540A	9" (228.6 mm)
BTP-650A	9" (228.6 mm)
BTP-740A	9" (228.6 mm)

Where an existing chimney or vent is to be used, be sure that the chimney or vent has adequate capacity for the number and sizes of gas appliances being vented through it. Inspect the chimney or vent and remove all soot or other obstructions which will retard free draft.

Vent connectors making horizontal runs must have a minimum upward slope toward the chimney or vent of 1/4 inch per foot. Vent connector length should be kept as short as possible. Be sure that the vent pipe does not extend beyond the inside wall of a chimney.

In venting systems where a continuous or intermittent back (positive) draft is found to exist, the cause must be determined and corrected. In some cases, a special vent cap may be required. Do not install this unit on the positive draft side of a venting system being served by a power exhauster.

HORIZONTAL (SIDE-WALL) VENTING FOR BTPV MODELS

An exhaust vent hood, vent hood and a flue reducer are supplied with any unit intended for through-the-wall horizontal venting. These parts must be installed without alteration. The vent hood adapter is designed for use with Selkirk Metalbestos Model PS or Model G venting. See Figure 17.

Refer to Table 6 for limitations of venting system design for horizontal venting.

TABLE 6.

		BTPV-540A-740A
Flue Outlet Dia. (Inches/mm)		9" (228.6)
Flue Reducer Dimensions - Supplied (Inches/mm)		9" x 8" 228.6 x 203.2
Minimum Outlet Vent Dia. (Inches/mm)		8" (203.2)
Maximum Number Of Elbows	90°	4
	45°	8
Maximum Total Vent System Length, Equiv. Feet/Meters		75 (23 m)

When calculating the equivalent length of a venting system each 90° elbow is equivalent to 10 feet (3 m) of straight pipe. 45° elbow is equivalent to 5 feet (1.5 m) of straight pipe. In no case may the sum of the straight pipe lengths and the equivalent length of the elbows exceed 80 feet (24.3 m).

Note the minimum vent diameter in Table 2.

Refer to Table 7. for the correct vent terminal size for each heater. The dimensions noted in Table 7. refer to Figure 17.

TABLE 7.

Heater Model	Terminal Model	A	B	C	D	Rough-In Dimensions
BTPV 540A- 740A	VH-1-8"	19-7/8"	13"	10-9/16"	8-5/8"	11-1/16"

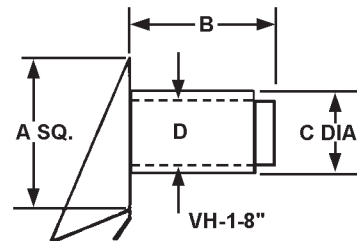

FIGURE 17.

Use only the sidewall vent terminal supplied with the heater. These terminals are specifically listed for use on these A.O. Smith heaters.

SIDEWALL TERMINATION INSTALLATION

1. If installing only vent (exhaust) piping in a Power Vent configuration through a sidewall; ensure that all exterior sidewall clearance requirements for the termination, shown in Figure 18A on page 20, are being maintained. These clearances and those cited by local and national codes must be maintained.
2. If installing both intake air and vent piping in a Direct Vent configuration through a sidewall; ensure that all exterior sidewall clearance requirements for the terminations, shown in Figure 18B on page 21, for the vent and intake air termination are being maintained. These clearances and those cited by local and national codes must be maintained.

VENT SYSTEM INSTALLATION

This heater is a category III appliance when horizontally vented through a wall using the supplied sidewall vent terminal. All national and local codes pertaining to the installation of such venting systems must be followed.

Horizontal portions of the vent system must be installed with a minimum upward slope of 1/4" per foot of length.

All joints and seams in the venting system must be sealed gas tight. If a silicone sealer is used, it must have a continuous temperature rating of at least 500°F (260°C); Dow Corning 736 or equivalent must be used.

CAUTION

Use only the vent hood supplied with this kit. Only supplied hood provides required clearances from combustibles, both through the wall and the exterior siding. Termination of a sidewall vent system with a device other than the supplied vent hood could affect system performance and result in a safety hazard.

IMPORTANT

Plan the layout of the vent system backward from the vent termination to the water heater.

1. Use the layout of the vent system backward from the vent termination to the water heater.

BEWARE OF CONCEALED WIRING AND PIPING INSIDE OF WALL. REFER TO TABLE 5 FOR THE MAXIMUM WALL THICKNESS "B" FOR EACH MODEL.

2. Slide hood through opening from outside. Fasten hood to exterior wall with anchors and screws supplied.
3. Install covers plate and fasten to inside wall with 4 screws.
4. Attach a seal ring (Meltalbestos SR or equivalent) to the vent hood collar, see Figures 6. & 7. Attach Selkirk Metalbestos model PS or model G venting to the seal ring following the venting manufacturer's instructions. For total safety, it is recommended that only venting listed for use with category III appliances (positive vent pressure, non-condensing) should be used between the heater and the vent hood, even through national or local codes may allow the use of type B or single-wall vent.
5. Install the remaining vent sections back to the heater, following the venting manufacturer's instructions on assembling and sealing joints. Follow good venting practice regarding properly supporting vent system and keeping the number of offsets to a minimum. See Table 2 for the maximum allowable number of elbows in venting system.

6. Install the flue reducer included with the exhaust hood between the vent system and the heater.
7. Seal all vent connections and venting with sealants supplied by vent pipe manufacturer or with a high-temperature silicone sealant suitable for continuous temperatures of 500°F (260°C). Acceptable sealant include Dow Corning 736 or equivalent.

DIRECT VENTING - FOR BTPV MODELS

All exhaust vent terminal, flue reducer, and intake vent terminal are supplied with any unit intended for direct venting. These parts must be installed without alteration.

This heater is category III appliance when used in a direct vent application. All national and local codes pertaining to the installation of such an appliance must be followed.

Horizontal portions of the exhaust vent system must be installed with a minimum upward slope of 1/4" (6.35 mm) per foot of length.

Selkirk metalbestos model PS or G vent is approved for use as exhaust venting on these models. Model PS is a double-wall vent with a 1" (25.4 mm) air space between pipes. Model G is a single-wall variation of model PS for use where combustible clearance is not a concern. See Table 8.

TABLE 8.

Selkirk Metalbestos Model PS Clearance to Combustibles	
Interior	6" (152.4 mm)
Exterior	6" (152.4 mm)

8" diameter PVC or galvanized pipe is approved for use as intake venting on these models. Class 63, 100, 125, 200, and schedule 40 pipe may be used for PVC pipe. Intake venting must be adequately supported to avoid unnecessary stress on vent hood, venting, or burner.

See Table 9. limitations on venting system design for direct vent installations.

TABLE 9.

Dimension in Inches (mm)	BTPV 540A-740A	
Flue Outlet Dia.	9 (229)	
Flue Reducer Dimension (Supplied)	9 x 8 (229 x 203)	
Min. Exhaust Vent Dia. Inch (mm)	8 (203)	
Min. Intake Vent Dia. Inch (mm)	8 (203)	
Maximum Number Of Elbows, Intake	90°	4
	45°	8
Maximum Number Of Elbows, Exhaust	90°	4
	45°	8
Total Intake Vent Length, Equiv. Ft.	Max.	75 (23 m)
	Min.	3 (1 m)
Total Exhaust Vent Length, Equiv. Ft.	Max.	75 (23 m)
	Min.	6 (1.8)

Note: Barometric draft control is not used in direct vent installations as the venting system must be sealed.

When calculating the equivalent length of a venting system each 90 elbow is equivalent to 10 feet of straight pipe. Each 45 elbow is equivalent to 5 feet (1.5 m) of straight pipe. Do not exceed the maximum number of elbows as shown in Table 5. In no case may the sum of the straight pipe lengths and the equivalent lengths of the elbows exceed the valves in Table 5.

TERMINATION CLEARANCES SIDEWALL POWER VENT

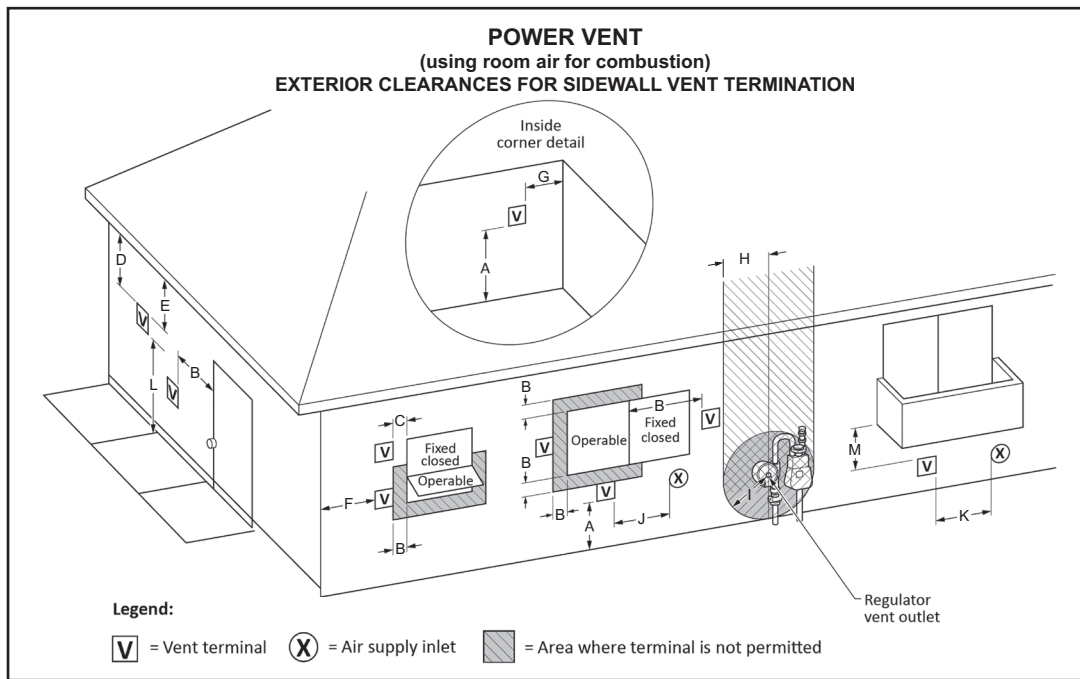

FIGURE 18A

Vent terminal clearances for “Power Vent” installations. Power Vent configurations use room air for combustion.

	CANADIAN INSTALLATIONS ¹		US INSTALLATIONS ²		CANADIAN INSTALLATIONS ¹		US INSTALLATIONS ²	
A	Clearance above grade, veranda, porch, deck or balcony	12 inches (30 cm)	12 inches (30 cm)	H	Clearance to each side of center line extended above meter/regulator assembly	Clearance in accordance with local installation codes and the requirements of the gas supplier	Clearance in accordance with local installation codes and the requirements of the gas supplier	
B	Clearance to window or door that may be opened	6 in (15 cm) for appliances ≤ 10,000 Btuh (3 kW), 12 in (30 cm) for appliances > 10,000 Btuh (3 kW) and ≤ 100,000 Btuh (30 kW), 36 in (91 cm) for appliances >100,000 Btuh (30 kW)	4 feet (1.2 m) below or to side of opening; 1 foot (30 cm) above opening	I	Clearance to service regulator vent outlet	Above a regulator within 3 ft (91 cm) horizontally of the vertical center line of the regulator vent outlet to a maximum vertical distance of 15 ft (4.5 m)	Clearance in accordance with local installation codes and the requirements of the gas supplier	
C	Clearance to permanently closed window	12 inches (30 cm)*	12 inches (30 cm)*	J	Clearance to a non mechanical air supply inlet into building or combustion air inlet to any other appliance	6 in (15 cm) for appliances ≤ 10,000 Btuh (3 kW), 12 in (30 cm) for appliances > 10,000 Btuh (3 kW) and ≤ 100,000 Btuh (30 kW), 36 in (91 cm) for appliances >100,000 Btuh (30 kW)	4 feet (1.2 m) below or to side of opening; 1 foot (30 cm) above opening.	
D	Vertical clearance to ventilated soffit located above the terminal within a horizontal distance of 2 feet (61 cm) from the center line of the terminal	12 inches (30 cm)*	12 inches (30 cm)*	K	Clearance to a mechanical air supply inlet	6 feet (1.83 m)	3 feet (91 cm) above if within 10 feet (3 m) horizontally	
E	Clearance to unventilated soffit	12 inches (30 cm)*	12 inches (30 cm)*	L	Clearance above paved sidewalk or paved driveway located on public property	7 feet (2.13 m)†	7 feet (2.13 m)	
F	Clearance to outside corner	2 feet (60 cm)*	2 feet (60 cm)*	M	Clearance under veranda, porch, deck, or balcony	12 inches (30 cm) ‡	12 inches (30 cm) ‡	
G	Clearance to inside corner	18 inches (45 cm)*	18 inches (45 cm)*					

¹ In accordance with the current CSA B149.1, Natural Gas and Propane Installation Code.

² In accordance with the current ANSI Z223.1/NFPA 54, National Fuel Gas Code.

† A vent shall not terminate directly above a sidewalk or paved driveway that is located between two single family dwellings and serves both dwellings. Where it may cause hazardous frost or ice accumulations on adjacent property surfaces.

‡ Permitted only if veranda, porch, deck, or balcony is fully open on a minimum of two sides beneath the floor.

* Clearance in accordance with local installation codes and the requirements of the gas supplier and the manufacturer's installation instructions.

Printed on 2/9/2021 9:24 AM CT

TERMINATION CLEARANCES SIDEWALL DIRECT VENT

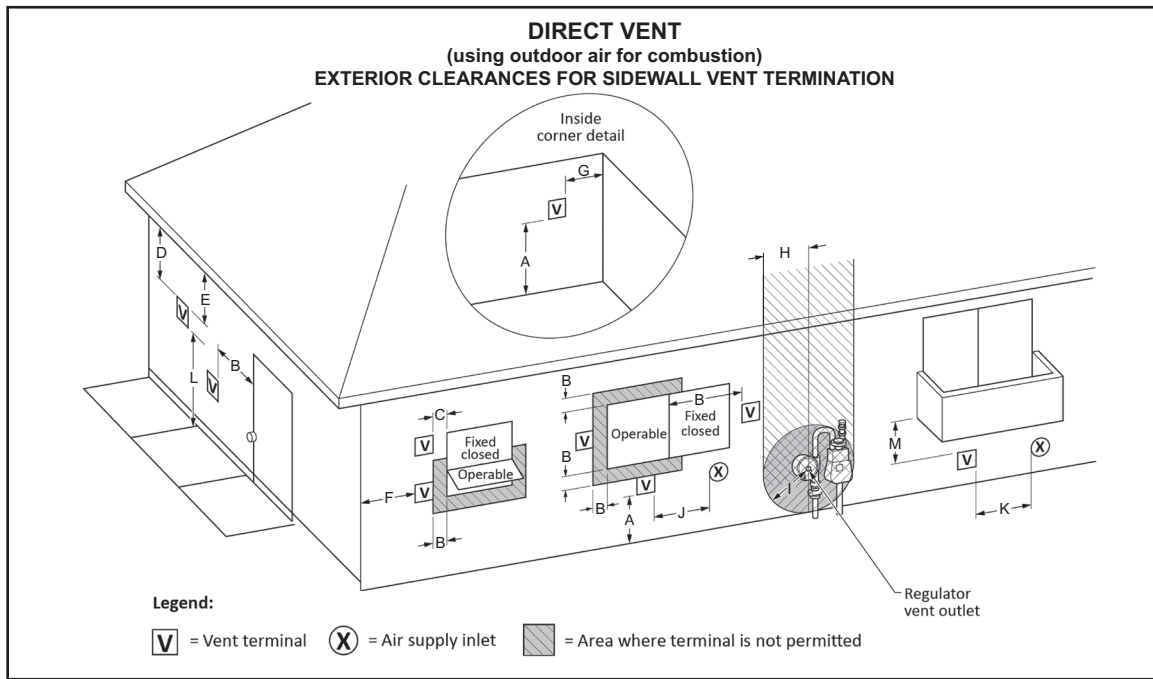

FIGURE 18B

Vent terminal clearances for “Direct Vent” installations. Direct Vent configurations use outdoor air for combustion.

		CANADIAN INSTALLATIONS ¹		US INSTALLATIONS ²		CANADIAN INSTALLATIONS ¹		US INSTALLATIONS ²	
A	Clearance above grade, veranda, porch, deck or balcony	12 inches (30 cm)	12 inches (30 cm)	H	Clearance to each side of center line extended above meter/regulator assembly	Clearance in accordance with local installation codes and the requirements of the gas supplier.	Clearance in accordance with local installation codes and the requirements of the gas supplier.		
B	Clearance to window or door that may be opened	6 in (15 cm) for appliances ≤ 10,000 Btuh (3 kW), 12 in (30 cm) for appliances > 10,000 Btuh (3 kW) and ≤ 100,000 Btuh (30 kW), 36 in (91 cm) for appliances > 100,000 Btuh (30 kW)	6 in (15 cm) for appliances ≤ 10,000 Btuh (3 kW), 9 in (23 cm) for appliances > 10,000 Btuh (3 kW) and ≤ 50,000 Btuh (15 kW), 12 in (30 cm) for appliances > 50,000 Btuh (15 kW)	I	Clearance to service regulator vent outlet	Above a regulator within 3 ft (91 cm) horizontally of the vertical center line of the regulator vent outlet to a maximum vertical distance of 15 ft (4.5 m)	Clearance in accordance with local installation codes and the requirements of the gas supplier		
C	Clearance to permanently closed window	6 inches (15 cm)*	6 inches (15 cm)*	J	Clearance to a non mechanical air supply inlet into building or combustion air inlet to any other appliance	6 in (15 cm) for appliances ≤ 10,000 Btuh (3 kW), 12 in (30 cm) for appliances > 10,000 Btuh (3 kW) and ≤ 100,000 Btuh (30 kW), 36 in (91 cm) for appliances > 100,000 Btuh (30 kW)	6 in (15 cm) for appliances ≤ 10,000 Btuh (3 kW), 9 in (23 cm) for appliances > 10,000 Btuh (3 kW) and ≤ 50,000 Btuh (15 kW), 12 in (30 cm) for appliances > 50,000 Btuh (15 kW)		
D	Vertical clearance to ventilated soffit located above the terminal within a horizontal distance of 2 feet (61 cm) from the center line of the terminal	12 inches (30 cm)*	12 inches (30 cm)*	K	Clearance to a mechanical air supply inlet	6 feet (1.83 m)	3 feet (91 cm) above if within 10 feet (3 m) horizontally		
E	Clearance to unventilated soffit	12 inches (30 cm)*	12 inches (30 cm)*	L	Clearance above paved sidewalk or paved driveway located on public property	7 feet (2.13 m)†	7 feet (2.13 m)†*		
F	Clearance to outside corner	2 feet (60 cm)*	2 feet (60 cm)*	M	Clearance under veranda, porch, deck, or balcony	12 inches (30 cm) ‡	12 inches (30 cm) ‡*		
G	Clearance to inside corner	18 inches (45 cm)*	18 inches (45 cm)*						

¹ In accordance with the current CSA B149.1, Natural Gas and Propane Installation Code.

² In accordance with the current ANSI Z223.1/NFPA 54, National Fuel Gas Code.

† A vent shall not terminate directly above a sidewalk or paved driveway that is located between two single family dwellings and serves both dwellings. Where it may cause hazardous frost or ice accumulations on adjacent property surfaces.

‡ Permitted only if veranda, porch, deck, or balcony is fully open on a minimum of two sides beneath the floor.

* Clearance in accordance with local installation codes and the requirements of the gas supplier and the manufacturer’s installation instructions.

DIRECT VENT SYSTEM INSTALLATION

Plan the vent system backwards from the vent hood to the heater.

1. Use the inside wall cover plate as a template to mark two holes in the appropriate places on the wall. Cut holes 1/2" (12.7 mm) larger to facilitate easy installation of vent hoods, see Figures 18B and 19.

BEWARE OF CONCEALED WIRING AND PIPING INSIDE WALL. REFER TO TABLE 3 FOR THE MAXIMUM WALL THICKNESS "B" FOR EACH MODEL.

2. Slide hoods through openings from outside. Fasten hoods to exterior wall with anchors and screws supplied.
3. Install cover plate and fasten to inside wall with 4 screws
4. Attach a seal ring (Selkirk Metalbestos Model SR or equivalent) to the vent hood collar, see Figure 19.
5. Attach a properly sized length of Selkirk Metalbestos model PS or model G venting to the exhaust vent adapter using the inner vee bands, see Figures 19 and 19B.
6. Fill the grooves in both inner vee bands with high-temp silicone sealant, Dow Corning 736 or equivalent.
7. Position the inner vee bands around the inner pipe flanges and tighten the screws securing the bands.
8. Align the outer channel band with the outer pipe grooves and tighten the screws securing the bands.
9. Repeat steps 6-8 for each successive pipe length until the venting reaches the heater.
10. Follow the manufacturer's instructions for proper support and guide spacing for horizontal runs of pipe, see Table 10.

11. Use an expansion joint between any two fixed points in the exhaust venting system wherever the expansion may exceed 1/4". Selkirk Metalbestos model PS and model G venting will expand by one inch per 100°F in gas temperature per 100 feet of vent length. The expansion can be calculated by the following formula:

$$\text{Expansion Inches} = \frac{\text{Vent length between two fixed points, feet}}{100} \times \frac{5}{100}$$

If the expansion calculated is greater than 1/4", an expansion joint must be used between the two fixed points.

12. Attach the flue reducer included in the exhaust vent hood package to the flue collar on the heater.
13. Attach the flue reducer to the vent system using a seal ring. Attach this ring to the venting using the inner vee bands as outlined in Steps 5-7.
14. Attach 8" air-intake connector to intake vent hood collar. It may be necessary to use a slip-slip coupling to fit the pipe to the intake vent hood.
15. Attach 8" air-intake connector back to the 6" burner air inlet with 8" x 6" reducer. Prime and cement each joint to assure gas-tight construction.
16. Seal all joints at the vent hoods with silicone sealant. Also seal the joints at the flue collar and air inlet adapter. Joint on the exhaust side must be sealed with high-temp silicone sealant, Dow Corning 736 or equivalent.

TABLE 10.

Vent Diameter	S	F
8" - BTP - 540A, 650A & 740A	15' 3"	15' 3"

S = Maximum spacing between two guides or a support and a guide in either a vertical or horizontal direction.

F = Maximum height above a guide or support for free standing system above a roof or parapet wall.

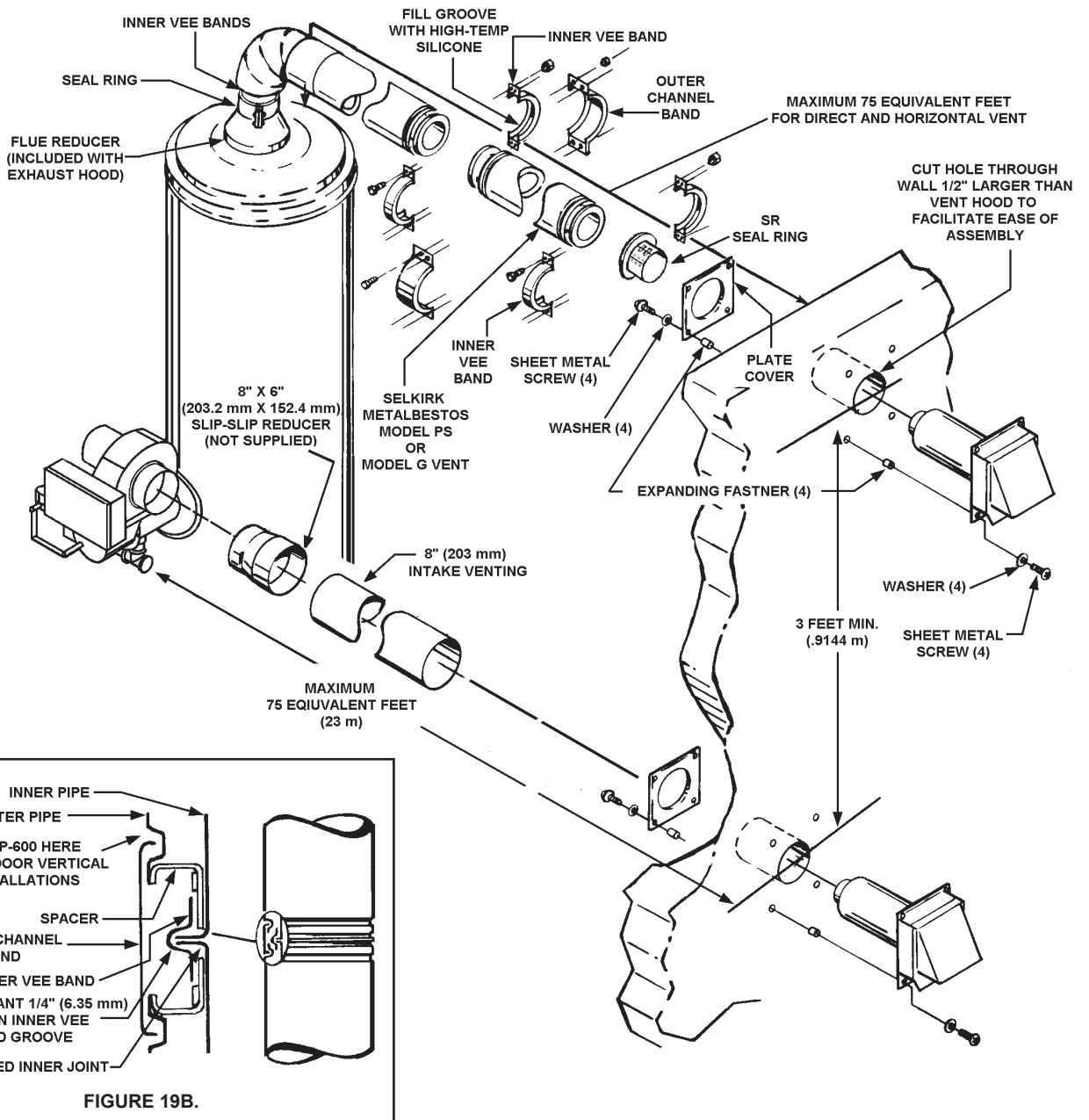

FIGURE 19.

WATER HEATER INSTALLATION

WATER LINE CONNECTIONS

The water piping installation must conform to these instructions and to all local code authority having jurisdiction. Good practice requires that all heavy piping be supported.

Read and observe all requirements in the following sections before installation of the water piping begins:

1. Water Temperature Control and Mixing Valves on page 13.
2. Dishwashing Machines on page 14.
3. Temperature-Pressure Relief Valve on page 14-15.
4. Closed Systems and Thermal Expansion on page 14.
5. For multiple water heater installations see Water Piping Diagrams beginning on page 41.

WATER (POTABLE) HEATING AND SPACE HEATING

1. All piping components connected to this unit for space heating applications shall be suitable for use with potable water.
2. Toxic chemicals, such as those used for boiler treatment, shall NEVER be introduced into this system.
3. This unit may NEVER be connected to any existing heating system or component(s) previously used with a non-potable water heating appliance.
4. When the system requires water for space heating at temperatures higher than required for domestic water purposes, a tempering valve must be installed. Please refer to installation diagrams beginning on page 39 of this manual for suggested piping arrangements.
5. These water heaters cannot be used in space heating applications only

THERMOMETERS (NOT SUPPLIED)

Thermometers should be obtained and field installed as shown in the installation diagrams.

Thermometers are installed in the system as a means of detecting the temperature of the outlet water supply.

WATER PIPING DIAGRAMS

This manual provides detailed water piping diagrams for typical methods of application for the water heaters, see Water Piping Diagrams beginning on page 39.

The water heater may be installed by itself, or with a separate storage tank. When used with a separate storage tank, the circulation may be either by gravity or by means of circulating pump. Adjust flow by throttling a full port ball valve installed in the circulating line on the outlet side of the pump. Never throttle flow on the suction side of a pump. See the Water Piping Diagrams beginning on page 39.

Call the toll free technical support phone number listed on the back cover of this manual for further assistance in sizing a T&P valve for remote storage tanks.

T&P VALVE DISCHARGE PIPE

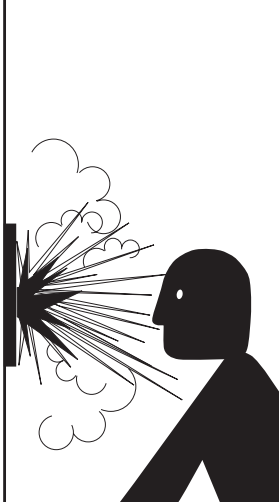
	! WARNING
	Explosion Hazard
	<ul style="list-style-type: none">• Temperature-Pressure Relief Valve must comply with ANSI Z21.22-CSA 4.4 and ASME code.• Properly sized temperature-pressure relief valve must be installed in opening provided.• Can result in overheating and excessive tank pressure.• Can cause serious injury or death.

This water heater is provided with a properly rated/sized and certified combination temperature - pressure (T&P) relief valve by the manufacturer. See Temperature-Pressure Relief Valve on pages 14-15 for information on replacement and other requirements.

CAUTION
Water Damage Hazard
<ul style="list-style-type: none">• Temperature-Pressure Relief Valve discharge pipe must terminate at adequate drain.

Install a discharge pipe between the T&P valve discharge opening and a suitable floor drain. Do not connect discharge piping directly to the drain unless a 6" (15.2 cm) air gap is provided. To prevent bodily injury, hazard to life, or property damage, the relief valve must be allowed to discharge water in adequate quantities should circumstances demand. If the discharge pipe is not connected to a drain or other suitable means, the water flow may cause property damage.

T&P VALVE DISCHARGE PIPE REQUIREMENTS:

- Shall not be smaller in size than the outlet pipe size of the valve, or have any reducing couplings or other restrictions.
- Shall not be plugged or blocked.
- Shall not be exposed to freezing temperatures.
- Shall be of material listed for hot water distribution.
- Shall be installed so as to allow complete drainage of both Temperature-Pressure Relief Valve and the discharge pipe.
- Must terminate a maximum of six inches above a floor drain or external to the building. In cold climates, it is recommended that the discharge pipe be terminated at an adequate drain inside the building.
- Shall not have any valve or other obstruction between the relief valve and the drain.

INSTALLATION DIAGRAMS - TOP INLET/OUTLET USAGE

Use of the top inlet water connection requires an inlet dip tube (refer to Figure 20). The tube is supplied in the heater. Follow caution labels if applying heat to this fitting. Do not allow pipe dope to contact the plastic tube during installation.

TUBE INLET INSTALLATION

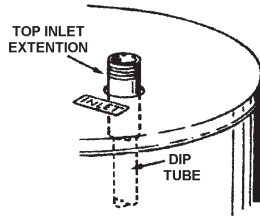

FIGURE 20.

HEATER WIRING

All electrical work must be installed in accordance with the current edition of the National Electrical Code ANSI/NFPA No. 70 or Canadian Electrical Code CSA C22.1 and must conform to all local code authority having jurisdiction. AN ELECTRICAL GROUND IS REQUIRED TO REDUCE RISK OF ELECTRICAL SHOCK OR POSSIBLE ELECTROCUTION.

If any of the original wire as supplied with the water heater must be replaced, use only type 105°C thermoplastic or equivalent 2500C type F must be used for the flame sensor and igniter leads.

The controls of this water heater are polarity sensitive. Be certain to properly wire the hot and neutral connections.

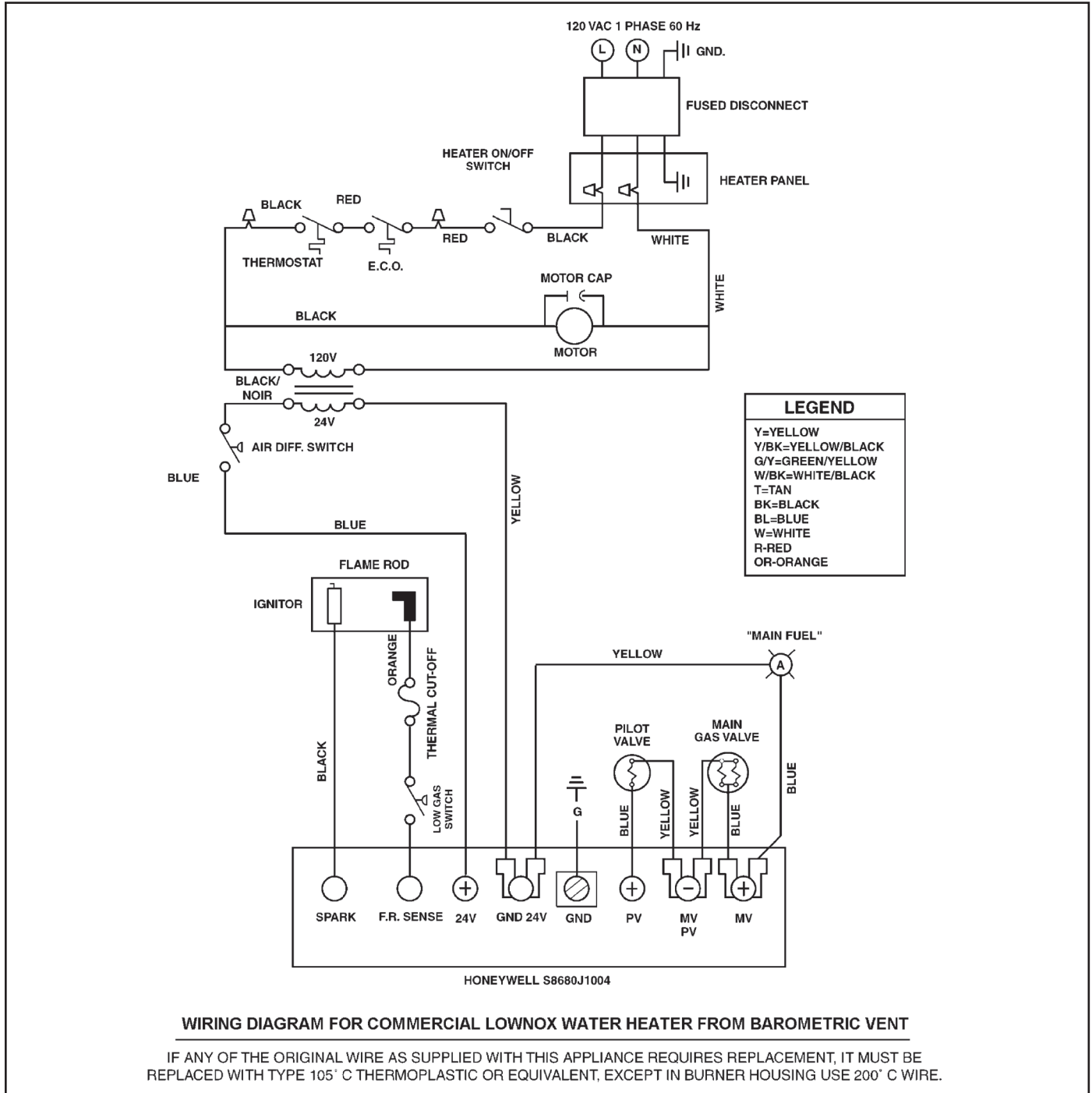
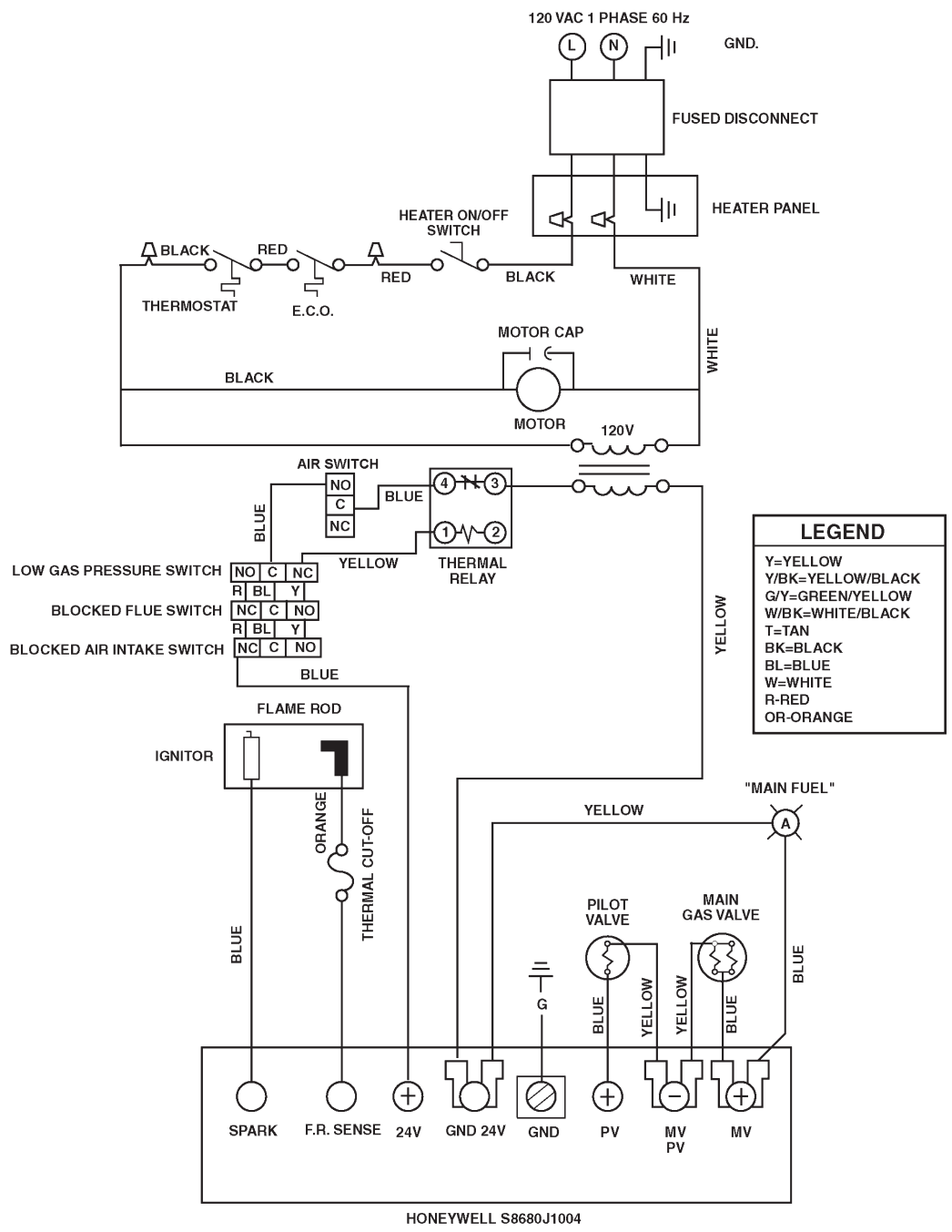

FIGURE 21.



WIRING DIAGRAM FOR COMMERCIAL LOWNOX WATER HEATER FOR HORIZONTAL & DIRECT VENT

IF ANY OF THE ORIGINAL WIRE AS SUPPLIED WITH THIS APPLIANCE REQUIRES REPLACEMENT, IT MUST BE REPLACED WITH TYPE 105° C THERMOPLASTIC OR EQUIVALENT, EXCEPT IN BURNER HOUSING USE 200° C WIRE.

FIGURE 22.

GAS PIPING

Contact your local gas service company to ensure that adequate gas service is available and to review applicable installation codes for your area.

Size the main gas line in accordance with Table 11. The figures shown are for straight lengths of pipe at 0.5 in. W.C. pressure drop, which is considered normal for low pressure systems. Note: Fittings such as elbows, tees and line regulators will add to the pipe pressure drop. Also refer to the latest version of the National Fuel Gas Code.

Schedule 40 Steel or Wrought Iron Pipe is the preferred material for the gas line of this water heater. It is imperative to follow the sizing recommendations in the latest version of the National Fuel Gas Code if Corrugated Stainless Steel Tubing (CSST) is used as the gas line for this water heater.

The heater is not intended for operation at higher than 14.0" W.C.- natural gas, (1/2 pound per square inch gage) supply gas pressure. Exposure to higher supply pressure may cause damage to the gas valve which could result in fire or explosion. If overpressure has occurred such as through improper testing of gas lines or

emergency malfunction of the supply system, the gas valve must be checked for safe operation. Make sure that the outside vents on the supply regulators and the safety vent valves are protected against blockage. These are parts of the gas supply system, not the heater. Vent blockage may occur during ice storms.

TABLE 11. MAXIMUM CAPACITY OF PIPE IN CUBIC FEET OF GAS PER HOUR

(Based upon a Pressure Drop of 0.5 inch Water Column and 0.6 Specific Gravity Gas and max. gas pressure of .5 psig)

LENGTH IN FEET	NOMINAL IRON PIPE SIZE (INCHES)								
	1/2	3/4	1	1 1/4	1 1/2	2	2 1/2	3	4
10	175	360	680	1,400	2,100	3,950	6,300	11,000	23,000
20	120	250	465	950	1,460	2,750	4,350	7,700	15,800
30	97	200	375	770	1,180	2,200	3,520	6,250	12,800
40	82	170	320	660	990	1,900	3,000	5,300	10,900
50	73	151	285	580	900	1,680	2,650	4,750	9,700
60	66	138	260	530	810	1,520	2,400	4,300	8,800
70	61	125	240	490	750	1,400	2,250	3,900	8,100
80	57	118	220	460	690	1,300	2,050	3,700	7,500
90	53	110	205	430	650	1,220	1,950	3,450	7,200
100	50	103	195	400	620	1,150	1,850	3,250	6,700
125	44	93	175	360	550	1,020	1,650	2,950	6,000
150	40	84	160	325	500	950	1,500	2,650	5,500
175	37	77	145	300	460	850	1,370	2,450	5,000
200	35	72	135	280	430	800	1,280	2,280	4,600

TABLE 11A.

LENGTH IN METERS	NOMINAL IRON PIPE SIZES, MILLIMETERS								
	1/2"	3/4"	1"	1 1/4"	1 1/2"	2"	2 1/2"	3"	4"
3.0	51	105	199	410	615	1160	1845	3221	6735
6.1	35	73	142	278	428	805	1277	2255	4626
9.1	28	59	110	225	346	644	1031	1830	3748
12.2	24	50	94	193	290	556	878	1552	3192
15.2	21	44	83	170	264	492	776	1391	2840
18.3	19	40	76	155	237	445	703	1259	2577
21.3	18	37	70	143	220	410	659	1142	2372
24.4	17	35	64	135	202	381	600	1083	2196
27.4	16	32	60	126	190	357	571	1010	2108
30.5	15	30	57	117	182	337	542	952	1962
38.1	13	27	51	105	161	299	483	864	1757
45.7	12	25	47	95	146	278	439	776	1610
53.3	11	23	42	88	135	249	401	717	1464
61.0	10	21	40	82	126	234	375	688	1347

It is important to guard against gas valve fouling from contaminants in gas ways. Such fouling may cause improper operation, fire or explosion.

If copper supply lines are used they must be internally tinned and certified for gas service. Before attaching the gas line, be sure that all gas pipe is clean on the inside.

To trap any dirt or foreign material in the gas supply line, a sediment trap must be incorporated in the piping (see Figure 23). The sediment trap must be readily accessible and not subject to freezing conditions. Install in accordance with recommendations of serving gas suppliers. Refer to the latest version of the National Fuel Gas Code.

To prevent damage, care must be taken not to apply too much torque when attaching gas supply pipe to gas valve inlet.

Apply joint compounds (pipe dope) sparingly and only to the male threads of pipe joints. Do not apply compounds to the first

two threads. Use compounds resistant to the action of liquefied petroleum gases.

GAS METER SIZE – NATURAL GASES ONLY

Be sure the gas meter has sufficient capacity to supply the full rated gas input of the water heater as well as the requirements of all other gas fired equipment supplied by the meter. If gas meter is too small, ask the gas company to install a larger meter having adequate capacity.

GAS PIPING AND SEDIMENT TRAP INSTALLATION

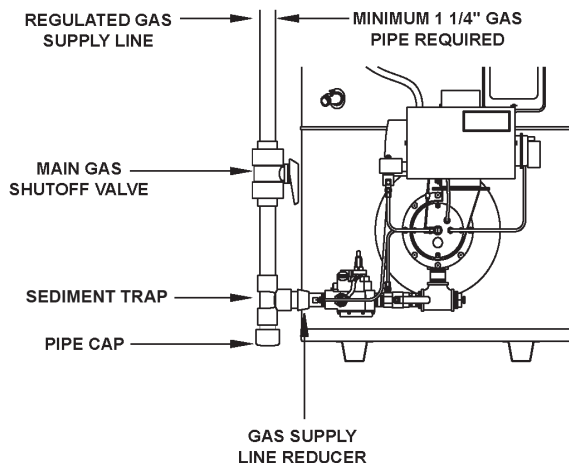

FIGURE 23.

GAS LINE LEAK TESTING

! WARNING

Fire and Explosion Hazard

- Use joint compound or Teflon tape compatible with propane gas.
- Leak test before placing the water heater in operation.
- Disconnect gas piping and main gas shutoff valve before leak testing.
- Install sediment trap in accordance with NFPA 54.

Any time work is done on the gas supply system perform a leak test to avoid the possibility of fire or explosion.

1. For test pressures exceeding 1/2 psi (3.45 kPa) disconnect the water heater and its Main Gas Shutoff Valve from the gas supply piping system during testing, see Figure 23. The gas supply line must be capped when disconnected from the water heater.
2. For test pressures of 1/2 psi (3.45 kPa) or less, the water heater need not be disconnected, but must be isolated from the supply gas line by closing the Main Gas Shutoff Valve during testing.
3. Coat all supply gas line joints and connections upstream of the water heater with a non-corrosive soap and water solution to test for leaks. Bubbles indicate a gas leak. Do not use matches, candles, flame or other sources of ignition for this purpose.
4. Repair any leaks before placing the water heater in operation.

PURGING

Gas line purging is required with new piping or systems in which air has entered.

Purging should be performed per the current edition of NFPA 54 the National Fuel Gas Code.

START-UP AND OPERATION

WARNING

Fire or Explosion Hazard

- Gas line purging is required with new piping or systems in which air has entered.
- To avoid risk of fire or explosion purge discharge must not enter into confined areas or spaces where ignition can occur.
- The area must be well ventilated and all sources of ignition must be deactivated or removed.



Read instruction manual before installing, using or servicing water heater.



- Attach a gas pressure gauge or manometer to upstream side of main gas cock and a gas pressure gauge or manometer to the manifold pressure tapping.
- Check voltage at disconnect switch to make certain that it matches that shown on the burner label.
- Apply a few drops of No. 20 SAE non-detergent oil to the motor bearings.
- Drill max. 5/16" hole in breeching as close as possible to flue connection on heater to install stack thermometer and combustion analyzing equipment. (See Figure 16).
- You are now ready to begin the burner start up procedure.

Installation and start up of this water heater requires abilities and skills equivalent to that of a licensed tradesman in the field involved, see Qualifications on page 6.

Do not place the water heater in operation if any part has been under water. Immediately call a qualified service technician to inspect the water heater and to replace any part of the control system and any gas control which has been under water.

Light the water heater in accordance with the Lighting and Operation Instruction label on the water heater and in this manual on pages 25.

Before attempting start up, thoroughly study and know the exact Sequence Of Operation. See written Sequence Of Operation on page 23 and Sequence Of Operation Flow Chart on page 24.

Be certain that the water heater is full of water, that air is purged from the gas and water lines and that there are no leaks in the gas and water lines. Ensure all inlet water valves are open.

FILLING THE WATER HEATER

Follow these steps to fill the water heater prior to start up.

1. Close the heater drain valve.
2. Open a nearby hot water faucet to permit air in system to escape.
3. Fully open the cold water inlet valve allowing the piping and water heater to fill with water.
4. Close hot water faucet opened in Step 2 as water starts to flow.

Read SEQUENCE OF OPERATION section of this manual prior to lighting and operating this water heater.

With above conditions satisfied, start the unit in accordance with the instructions on the operating label attached to the heater. For your convenience a copy of the instructions are shown on pages 25.

PRIOR TO START UP

This product requires a formal Start-Up by an authorized service/start-up provider that has been approved by the manufacturer for this specific product. Call 1-800-527-1953 to locate the nearest authorized start-up provider and arrange a factory start-up. Please provide as much notice as possible, preferably 2 weeks. Please have the model and serial number ready when you call.

This start-up is required to activate the warranty and ensure safe, efficient operation.

Warranty on this product is limited and could be void in the event the unit is not installed per the instructions in this manual and/or not started up by an authorized factory trained service/start-up provider.

The following test equipment should be on hand: (all test equipment must be acclimated to ambient temperature before calibration and use.)

1. CO₂ indicator (Fyrite or similar) or O₂ analyzer
2. CO indicator (Monoxor or similar)
3. Stack thermometer
4. Draft Gauge or inclined manometer
5. Two U-tube manometers or calibrated 0-10" and 0-35" w.c. pressure gauges.
6. Combination volt/ammeter.

SEQUENCE OF OPERATION

The following information will describe the Sequence of Operation for this water heater.

1. Power on.
2. Heater in standby mode.
3. Thermostat calls for heat.
4. Blower motor starts.
5. Blower operation closes the normally open blower prover / blocked outlet safety pressure switch.
6. On proof of airflow, Honeywell S8680J flame control module energized.
7. 45 seconds prepurge cycle begins.
8. Following prepurge cycle, the pilot gas valve is energized.
9. At the same time, the electronic spark generator in the module produces a high voltage spark pulse output.

10. The voltage generates a spark at the ignitor that lights the pilot.
11. If the pilot does not light (or flame signal is less than 1 micro A) within 15 seconds system locks out and must be reset by turning burner switch "OFF" for a minimum of 1 minute. During system lockout, blower still runs.
12. When the pilot flame is established (flame is sensed by flame rod), the main gas valve is energized.
13. Main gas flows to main burner where it's ignited by the pilot flame. Now heater is in Heating Mode.
14. During the Heating Mode:
 - If gas line pressure drops below the setting point, the flame module is de-energized, gas valves closed, blower still runs.
 - If gas line pressure drops below the setting point then gas line pressure increases to above the setpoint, heater starts again from purging cycle.

If gas line pressure fluctuates around the setpoint too quick (less than a second) burner may still run with excessive gas valve ON/OFF cycle you must turn off the unit immediately, re-adjust the gas line regulator and/or install a larger gas supply line!

If the blower inlet and/or intake hood, or flue outlet/hood is/ are blocked for any reason, the safety switches will open, which will de-energize the flame control module.

15. The spark generator is off.
16. The flame module monitors pilot flame current. Should the flame failure occur during the Heating Mode, the unit will start again from purging cycle.
17. Thermostat is satisfied, switch opens.
18. Power is interrupted to the flame control module and blower motor. Gas valves are closed.
19. Heater is in Standby Mode.
20. Thermostat is satisfied, switch opens.
21. Power is interrupted to burner, turning off blower and ignition control module. Solenoid and main gas valves are closed.
22. Insufficient blower pressure causes safety pressure switches to open.

Printed on 2/9/2021 9:24 AM CT

FOR YOUR SAFETY READ BEFORE LIGHTING





WARNING: If you do not follow these instructions exactly, a fire or explosion may result causing property damage, personal injury or loss of life.



BEFORE OPERATING: ENTIRE SYSTEM MUST BE FILLED WITH WATER AND AIR PURGED FROM ALL LINES.

A. This appliance is equipped with an ignition device which automatically lights the burner.
Do NOT try to light burner by hand.

B. **BEFORE LIGHTING:** Smell all around the appliance area for gas. Be sure to smell next to the floor because some gas is heavier than air and will settle on the floor.

WHAT TO DO IF YOU SMELL GAS:

- Do not try to light any appliance.
- Do not touch any electric switch; do not use any phone in your building.
- Immediately call your gas supplier from a neighbor's phone. Follow the gas supplier's instructions.

• If you cannot reach your gas supplier, call the fire department.

C. Use only your hand to push in or turn the gas control knob. Never use tools. If the knob will not push in or turn by hand, don't try to repair it, call a qualified service technician. Force or attempted repair may result in a fire or explosion.

D. Do not use this appliance if any part has been under water. Immediately call a qualified service technician to inspect the appliance and to replace any part of the control system and any gas control which has been under water.

E. Do not operate appliance unless unit is filled with water and inlet lines are fully open.

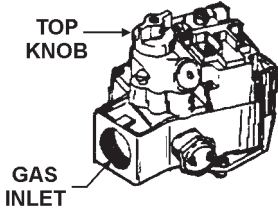
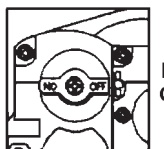
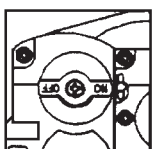

FIGURE "A"







"OFF POSITION"

FIGURE "B"



"ON POSITION"

OPERATING INSTRUCTIONS

1.  **STOP!** Read the safety information above on this label.
2. Remove appliance thermostat cover. Rotate thermostat dial counterclockwise  to lowest setting.
3. Turn off all electric power to the appliance.
4. This appliance is equipped an ignition device which automatically lights the burner. Do NOT try to light the burner by hand.
5. Refer to diagrams above. Turn top knob of gas control clockwise to "OFF" position (Figure A).
6. Wait five (5) minutes to clear out any gas. If you then smell gas,  **STOP!** Follow "B" in the safety information above on this label. If you don't smell gas, go to next step.
7. Turn top knob of gas control counterclockwise  to "ON" (Figure B).
8. Turn on all electric power to the appliance.
9. Set thermostat to desired setting.
10. Turn switch to "ON" position.
11. Heater will automatically begin operation. Blower motor will run approximately 40 seconds, then pilot gas valve will open. Upon confirming the pilot flame the main gas valve will open and the heater will operate in heating mode. Reference "Sequence of Operation" section of manual for details.
12. Heater is equipped with an ignition module which locks out after one (1) unsuccessful ignition attempt. Blower motor will continue to run. If lockout occurs, turn burner switch to "OFF" position for at least one minute, then turn the switch back to "ON". Heater will automatically begin operation.
13. Replace thermostat control cover.
14. If the appliance will not operate, follow the instructions "TO TURN OFF GAS APPLIANCE" and call your service technician or gas supplier.

TO TURN OFF GAS TO APPLIANCE

1. Remove thermostat control cover.
2. Set thermostat to lowest setting.
3. Turn burner switch to "OFF".
4. Turn off all electric power to the appliance if service is to be performed.
5. Turn top knob of gas control to the "OFF" position. Refer to Step 5 of 'OPERATING INSTRUCTION' above.
6. Replace thermostat control cover.

FIGURE 24. LABEL FOR NATURAL GAS MODELS

ADJUSTMENTS

A minimum dynamic gas supply pressure of 8" w.c. for natural gas is required before making any adjustment to the gas control pressure regulator. Attempts to adjust the regulator during periods of low gas supply pressure could result in overfiring of the heater when the gas supply pressure returns to normal.

1. Check gas line pressure with a manometer.

Set initial gas line pressure at 9-10" w.c. before turning the heater "ON".

Read gas line pressure and gas manifold pressure when the heater main gas is "ON".

Adjust gas line regulator setting if the gas line pressure drops below 8" w.c. when heater main gas is "ON".

Check heater gas manifold pressure (see Table 3) using a manometer connected to the manifold pressure tap on the Robertshaw gas control valve, see Figure 32.

Important Note: Use gas manifold pressure as initial setup only. The final air and gas settings should be based on fire rate and flue gas O₂/CO₂ reading, see Table 10 for normal O₂/CO₂ reading.

WARNING

Excessive gas line pressure drop and/or burner manifold pressure too low may cause burner start/operate with excessive noise!

2. Cycle the burner "ON" and "OFF" several times to check its operation. Make sure the gas line pressure is below 14" w.c. when burner is "OFF". If gas line pressure exceeds 14" w.c. when the burner is off, the gas supply line size must be increased to correct this problem (see Table 9 for gas pipe size).
3. Check the operation of the limiting and operating controls.
4. Check the vent system seams and joints and ensure that there is no discharge of flue products into the room. For standard vertical vent systems, check the barometric damper control to make sure it operates freely and there is no discharge of flue products into the room.
5. Check the input rate by clocking the gas meter.

ADJUSTMENT PROCEDURE FOR FIRE-RATE, LOW NOX AND HIGH ELEVATION (Fine-Tune)

An acceptable input rate is within 2% of the rated input for the model. Should it be necessary to adjust the gas pressure to the burner and/or air damper of the blower to obtain the full input rate, these steps should be followed:

WARNING

Never set burner combustion too lean (causing noisy operation) or too rich (causing combustion chamber premature failure) see Table 3 for proper settings.

WARNING

Never set the air damper outside of its adjustment range of the rated fire rate unless authorized by an A. O. Smith Service Center.

Important Note: Final gas and air settings should be based on flue gas CO₂ or O₂ reading (see Table 3). Increase burner manifold pressure will increase fire rate and flue gas CO₂ reading. Increase air damper setting will decrease fire rate and decrease flue gas CO₂ reading. Adjustable air damper is preset for the rated fire-rate prior to delivery, should not be re-adjusted unless it's a high elevation application and/or a direct vent (long air intake vent) application.

1. Fire Rate Adjustment (including direct vent installation).
 - a. Make sure the gas supply line pressure reads 8" w.c. (2 kPa) or higher when the heater is running.
 - b. Remove the pressure regulator cover screw (Figure 32) and adjust the pressure by tuning the adjustment screw w/a small screwdriver clockwise to increase gas pressure into the burner and fire rate. Counterclockwise to decrease gas pressure and input rate.
 - c. Clock gas meter, repeat above Step (b) to achieve the specific input rate.
 - d. Measure flue gas O₂ and/or CO₂ (see Table 10) for acceptable O₂/CO₂ range.

If the O₂ or CO₂ reading is within the acceptable range, then proceed to Step (f).

If the O₂ or CO₂ reading is out of range, adjust air damper is required.
 - e. Repeat Steps (b), (c), (d) if air damper is adjusted.
 - f. Cycle heater ON/OFF.
 - g. Replace the gas regulator cover, pressure tap and tighten the damper center bolt.

2. Adjustment for Low NOx Emission Application.

The water heater is preset at factory for Low Nox emission combustion. Due to the installation variations, fine-tune adjustments may be required. To lower NOx emission level (30PPM corrected at 3% O₂ or lower is required by SCAQMD), air damper setting may need to be slightly increased. To increase air damper setting, loosen the center nut of the inlet air damper, rotate the damper clockwise slightly, then tighten the center nut. After re-set the air damper, cycle heater ON/OFF and check fire-rate and flue gas CO₂/O₂ reading.

3. Adjustment for High Elevation Application

Installation above 2000 feet sea level requires new air damper settings. All final settings should be based on flue gas CO₂/O₂ reading, see Table 3. To increase air damper setting, loosen the center bolt of the inlet air damper, rotate the damper clockwise slightly, then tighten the center bolt. After re-setting the air damper, cycle heater ON/OFF and check fire-rate and flue gas CO₂/O₂ reading.

WARNING

UNDER NO CIRCUMSTANCES SHOULD THE INPUT RATE EXCEED THE INPUT RATE SHOWN IN THE HEATER RATING PLATE. OVERFIRING COULD RESULT IN DAMAGE OR SOOTING OF THE HEATER.

SHOULD OVERHEATING OCCUR OR GAS SUPPLY FAIL TO SHUT OFF, TURN OFF THE MANUAL GAS CONTROL VALVE TO THE APPLIANCE.

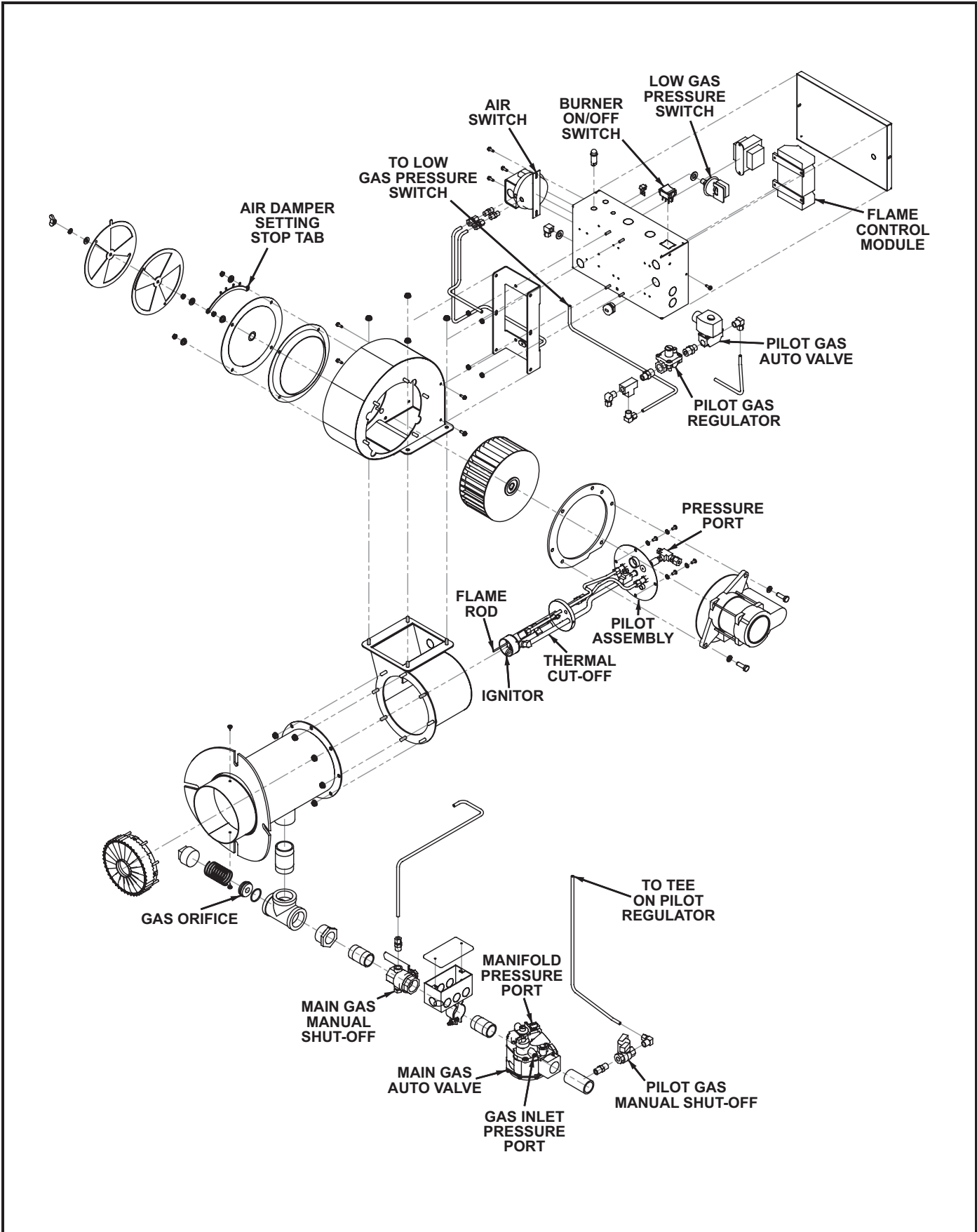

PREMIX LOW NO_x BURNER - EXPLODED VIEW FOR BTP MODELS
FIGURE 25.

For all parts on this burner contact: Power Flame www.powerflame.com

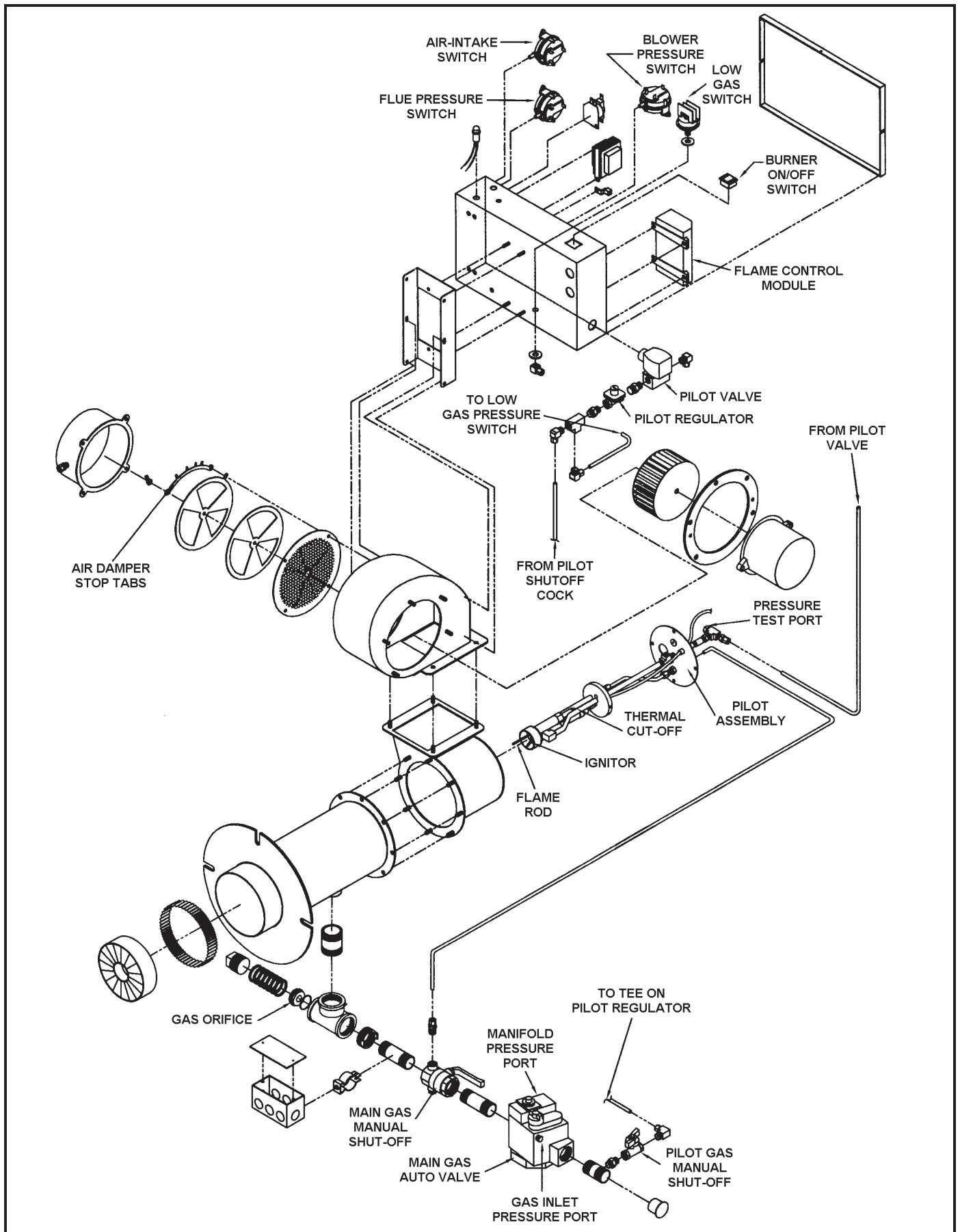

PREMIX LOW NO_x BURNER - EXPLODED VIEW FOR BTPV MODELS
FIGURE 26.

For all parts on this burner contact: Power Flame www.powerflame.com

MAINTENANCE

VENTING SYSTEM AND BAROMETRIC DRAFT CONTROL

The heater is equipped with a double acting barometric draft control. This control assembly is factory adjusted to automatically regulate the chimney draft imposed on the unit. The damper gate must pivot freely in the ring guides. See Figure 27.

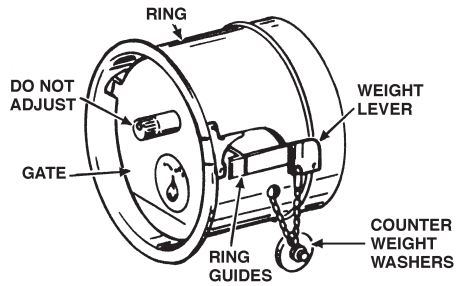

**BAROMETRIC DRAFT CONTROL
FIGURE 27.**

Examine the venting system every six months for obstructions and/or deterioration of the vent piping.

Remove all soot or other obstructions from chimney which will retard free draft.

GENERAL

Water heater maintenance includes periodic tank flushing and cleaning, and removal of lime scale. The power burner should be inspected and adjusted to maintain proper combustion. Refer to Table 12. A periodic inspection of the venting system and barometric damper should be made. Where used, the water heating system circulating pump should be oiled per manufacturer's instructions.

Following are the instructions for performing some of the recommended maintenance. Power burner inspection and adjustment should be performed by a competent technician.

**TABLE 12.
RECOMMENDED MAINTENANCE SCHEDULE
FOR THE BTP HEATER**

COMPONENTS	OPERATION	INTERNAL	REQUIRED
Tank	Flushing	Monthly	
	Sediments Removal	Semi-Annually	
	Lime Scale Removal	As Required	Unlime Delimer
Relief Valve	Inspect	Semi-Annually	
Circulating Pump and Power Burner Motor	Oiling	Quarterly	SAE No. 20 Non-Detergent Motor Oil
Power Burner and Ignition Device	Inspection and Adjustment	Semi-Annually	Combustion Test Kit and Test Specifications
Main Burner Vent System and	Inspect	Semi-Annually	
Barometric Damper	Inspect	Semi-Annually	Draft Gauge
Anode(s)	Inspect	Annually	

REMOTE STORAGE TANK TEMPERATURE CONTROL

Water temperature in remote storage tank (if used) is controlled by the storage tank temperature control. The sensing element is mounted in the hot water storage tank, see Water Piping Diagram section.

A change in water temperature in the storage tank lower than the tank temperature control setting will cause the sensor to activate the circulating pump. The pump then circulates the water through the

heater where the thermostat senses the drop in water temperature and activates main burner operation of the water heater.

If the storage tank temperature control is out of calibration, replace with new control.

SHOULD OVERHEATING OCCUR OR THE GAS SUPPLY FAIL TO SHUT OFF, TURN OFF THE MANUAL GAS CONTROL VALVE TO THE Water heater.

TEMPERATURE-PRESSURE RELIEF VALVE TEST

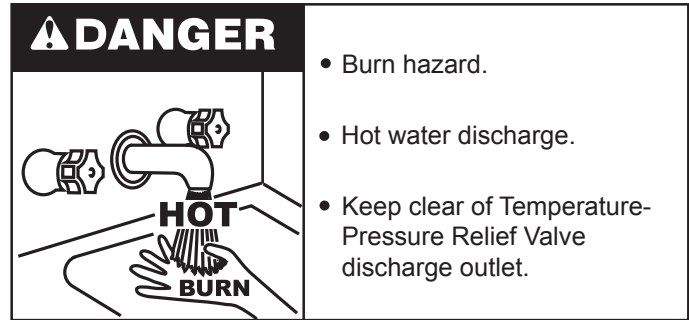

It is recommended that the Temperature-Pressure Relief Valve should be checked to ensure that it is in operating condition every 6 months.

When checking the Temperature-Pressure Relief Valve operation, make sure that (1) no one is in front of or around outlet of Temperature-Pressure Relief Valve discharge line, and (2) that water discharge will not cause any property damage, as water may be extremely hot. Use care when operating valve as valve may be hot.

To check the pressure relief valve, lift lever at the end of valve several times, see Figure 28. The valve should seat properly and operate freely.

If after manually operating the valve, it fails to completely reset and continues to release water, immediately close the cold water inlet to the water heater and drain the water heater, see Draining And Flushing on page 32. Replace the Temperature-Pressure Relief

Valve with a properly rated/sized new one, see Temperature-Pressure Relief Valve on pages 14-15 for instructions on replacement.

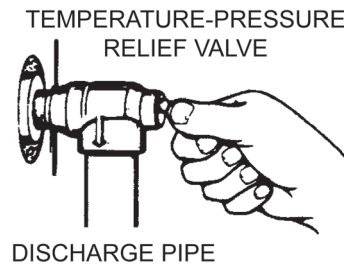

FIGURE 28.

If the Temperature-Pressure Relief Valve on water heater weeps or discharges periodically, this may be due to thermal expansion.

NOTE: Excessive water pressure is the most common cause of Temperature-Pressure Relief Valve leakage. Excessive water system pressure is most often caused by "thermal expansion" in a "closed system." See Closed Water Systems and Thermal Expansion on page 14. The Temperature-Pressure Relief Valve is not intended for the constant relief of thermal expansion.

Temperature-Pressure Relief Valve leakage due to pressure build up in a closed system that does not have a thermal expansion tank installed is not covered under the limited warranty. Thermal expansion tanks must be installed on all closed water systems.

DO NOT PLUG THE TEMPERATURE-PRESSURE RELIEF VALVE OPENING. THIS CAN CAUSE PROPERTY DAMAGE, SERIOUS INJURY OR DEATH.

Printed on 2/9/2021 9:24 AM CT

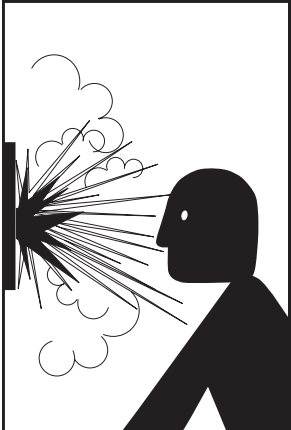
	<h1>WARNING</h1>
	<h2>Explosion Hazard</h2> <ul style="list-style-type: none"> • Temperature-Pressure Relief Valve must comply with ANSI Z21.22- CSA 4.4 and ASME code. • Properly sized temperature-pressure relief valve must be installed in opening provided. • Can result in overheating and excessive tank pressure. • Can cause serious injury or death.

ANODE ROD INSPECTION

<h1>CAUTION</h1>
<h2>Property Damage Hazard</h2>
<ul style="list-style-type: none"> • Avoid water heater damage. • Inspection and replacement of anode rod required.

The anode rod is used to protect the tank from corrosion. Most hot water tanks are equipped with an anode rod. The submerged rod sacrifices itself to protect the tank. Instead of corroding tank, water ions attack and eat away the anode rod. This does not affect water's taste or color. The rod must be maintained to keep tank in operating condition.

Anode rod deterioration depends on water conductivity, not necessarily water condition. A corroded or pitted anode rod indicates high water conductivity and should be checked and/or replaced more often than an anode rod that appears to be intact. Replacement of a depleted anode rod can extend the life of your water heater. Inspection should be conducted by a qualified technician, and at a minimum should be checked annually after warranty period.

Artificially softened water is exceedingly corrosive because the process substitutes sodium ions for magnesium and calcium ions. Use of a water softener may decrease the life of water heater tank.

The anode rod should be inspected after a maximum of three years and annually thereafter until condition of anode rod dictates its replacement. Anode replacement is not covered by warranty. NOTE: artificially softened water requires the anode rod to be inspected annually.

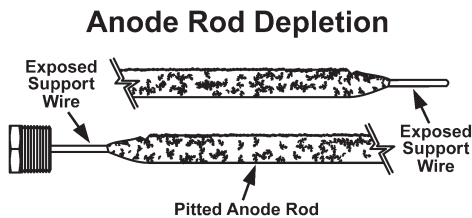

DRAINING AND FLUSHING

	<h1>DANGER</h1>
	<ul style="list-style-type: none"> • Burn hazard. • Hot water discharge. • Keep hands clear of drain valve discharge.

It is recommended that the water heater storage tank be drained and flushed every 6 months to reduce sediment buildup. The water heater should be drained if being shut down during freezing temperatures. See Features And Components in this manual for the location of the water heater components described below.

TO DRAIN THE WATER HEATER STORAGE TANK:

1. Turn off the electrical supply to the water heater.
2. Turn off the gas supply at the Main Gas Shutoff Valve if the water heater is going to be shut down for an extended period.
3. Ensure the cold water inlet valve is open.
4. Open a nearby hot water faucet and let the water run until the water is no longer hot.
5. Close the cold water inlet valve to the water heater.
6. Connect a hose to the water heater drain valve and terminate it to an adequate drain.
7. Open the water heater drain valve and allow all the water to drain from the storage tank.
8. Close the water heater drain valve when all water in the storage tank has drained.
9. Close the hot water faucet opened in Step 4.
10. If the water heater is going to be shut down for an extended period, the drain valve should be left open.

TO FLUSH THE WATER HEATER STORAGE TANK:

1. Turn off the electrical supply to the water heater.
2. Ensure the cold water inlet valve is open.
3. Open a nearby hot water faucet and let the water run until the water is no longer hot. Then close the hot water faucet.
4. Connect a hose to the drain valve and terminate it to an adequate drain.
5. Ensure the drain hose is secured before and during the entire flushing procedure. Flushing is performed with system water pressure applied to the water heater.
6. Open the water heater drain valve to flush the storage tank.
7. Flush the water heater storage tank to remove sediment and allow the water to flow until it runs clean.
8. Close the water heater drain valve when flushing is completed.
9. Remove the drain hose.
10. Fill the water heater - see Filling The Water Heater in this manual.
11. Turn on electrical supply to place water heater back in operation.
12. Allow the water heater to complete several heating cycles to ensure it is operating properly.

RECOMMENDED PROCEDURE FOR PERIODIC REMOVAL OF LIME DEPOSITS FROM TANK TYPE COMMERCIAL WATER HEATERS

The amount of calcium carbonate (lime) released from water is in direct proportion to water temperature and usage, see chart. The higher the water temperature or water usage, the more lime deposits are dropped out of the water. This is the lime scale which forms in pipes, heaters and on cooking utensils.

Lime accumulation not only reduces the life of equipment but also reduces efficiency of the heater and increases fuel consumption.

The usage of water softening equipment greatly reduces the hardness of the water. However, this equipment does not always remove all of the hardness (lime). For this reason it is recommended that a regular schedule for deliming be maintained.

The time between cleaning will vary from weeks to months depending upon water conditions and usage.

The depth of lime buildup should be measured periodically. Heaters equipped with cleanouts will have about 2" of lime buildup when the level of lime has reached the bottom of the cleanout opening. A schedule for deliming should then be set up, based on the amount of time it would take for a 1" buildup of lime. It is recommended that the water heater initially be inspected after 6 months.

Example 1:

Initial inspection after 6 months shows 1/2" of lime accumulation. Therefore, the heater should be delimed once a year.

Example 2:

Initial inspection after 6 months shows 2" of lime accumulation. Therefore, the heater should be delimed every 3 months.

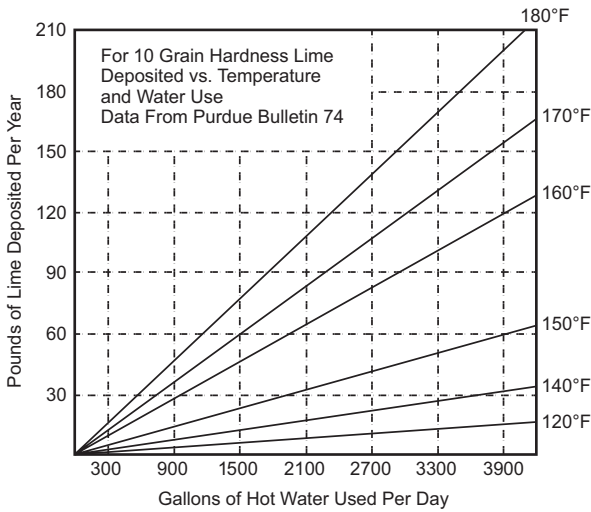

FIGURE 29.

DELIMING SOLVENTS

UN•LIME is recommended for deliming. UN•LIME is a patented food grade acid which is safe to handle and does not create the harmful fumes which are associated with other products.

UN•LIME may be obtained from your dealer, distributor or water heater manufacturer. Order Part Number 100110459, 1 gallon, packed 4 gallons per case or Part Number 100110460, 5 gallon container.

NOTE: Un•Lime is not available for use in Canada.

Hydrochloric base acids are not recommended for use on glass lined tanks.

Observe handling instructions on label of product being used.

TANK CLEANOUT PROCEDURE

The following practices will ensure longer life and enable the unit to operate at its designed efficiency:

1. Once a month the heater should be flushed. Open drain valve and allow two gallons of water to drain from heater. Inlet water valve should remain open to maintain pressure in tank.
2. A cleanout opening is provided for periodic cleaning of the tank. Gas must be shut off and heater drained before opening cleanout.

To clean heater through cleanout opening, proceed as follows:

3. Drain heater.
4. Remove outer cover plate from lower side of heater jacket.
5. Remove six (6) hex head screws securing tank cleanout plate and remove plate.
6. Remove lime, scale, or sediment using care not to damage the glass lining.
7. Inspect cleanout plate gasket, if new gasket is required, replace with part no. 100109686.
8. Install cleanout plate. Be sure to draw plate up tight by tightening screws securely.
9. Replace outer jacket cover plate.

In some water areas the sediment might not be removed by this method and may result in the water heater making rumbling or boiling noises. To dissolve and remove these more stubborn mineral deposits, UN•LIME Professional Delimer should be used.

DELIMING USING FLO-JUG METHOD

UN•LIME in the 5 gallon size is recommended for delimiting of all models. Contact your local dealer, distributor or, water heater manufacturer:

Prepare the Water Heater

To delime the water heater using the Flo-Jug method, first prepare the heater for delimiting.

	<h1>! WARNING</h1>
	<h2>Explosion Hazard</h2> <ul style="list-style-type: none"> • Flammable hydrogen gases may be present. • Keep all ignition sources away from faucet when turning on hot water.

Do not smoke or have open flame or sparks in vicinity of heater. Do not mix UN•LIME with other chemicals. Do not allow contact with magnesium, aluminum or galvanized metals.

	<h1>! CAUTION</h1>
	<h2>Chemical Hazard</h2> <ul style="list-style-type: none"> • Product contains phosphoric acid. • Keep out of reach of children. • Use rubber or neoprene gloves.

Contains phosphoric acid. In case of external contact, flush with cool water. If irritation persists, get medical attention. If swallowed, give 1 or 2 glasses of water or milk and call physician.

Get immediate medical attention for eyes. Keep out of reach of children.

NOTE: THE USE OF RUBBER OR NEOPRENE GLOVES IS RECOMMENDED, ESPECIALLY IF YOU HAVE ANY OPEN SORES OR CUTS TO AVOID UNNECESSARY IRRITATION OR DISCOMFORT.

1. Turn off fuel and/or power supply to heater. Also, turn off power to any electrical device or equipment, which is attached, or part of the system.
2. Open hot water side of faucet closest to heater and allow water to run until it is cool enough to handle safely.
3. Close cold water inlet valve to heater.
4. Connect hose to drain valve at bottom of heater and start draining heater into suitable floor drain area.
5. Remove pressure relief valve while heater is draining. NOTE: Do not replace pressure relief valve until delimiting is completed. Pressure relief valve opening will also act as a vent in case of possible contact between the delimer and the anode rod(s), which may produce flammable hydrogen-air mixtures.
6. If pressure relief valve appears to be limed-up, place it in a clean glass or plastic container adequate in size so that you can pour enough UN•LIME® into container to cover the valve and allow space for foaming. When foaming stops, run fresh cool water into the container and rinse the pressure relief valve for a few minutes.
7. If heater does not drain completely after a reasonable length of time, turn off the main water supply valve to stop water from entering the tank due to a by-pass problem or defective cold water inlet valve. Also, check for clogged drain valve opening. Heater must be completely drained before introducing UN•LIME.
8. Remove the cleanout cover and place a clean plastic bucket next to the cleanout opening. Partially open the cold water inlet valve to allow time to accomplish the following and then close the valve.

While the water is being run through the tank, insert a stiff wire, copper tube flattened at one end or an opened wire coat hanger through the cleanout opening and scrape out any loose deposits of scale or sediment. This is an economical way to avoid unnecessary usage of the deliming solution.

Repeat the opening and closing of the cold water inlet valve as necessary but be sure the heater is completely drained when ready to introduce the UN•LIME.

Upon completion, reinstall the cleanout cover and use a new cleanout cover gasket (part number 100109686).

Remove the drain valve.

9. Install the long plastic male adapter insert fitting into the drain valve opening of heater after applying Teflon tape or paste to threads. Tighten firmly by hand and use wrench or adjustable pliers to check for secure connection. Do not over tighten to avoid damage to threads and fittings.

Prepare the Up-N-Down Transfer Kit

The next step is the preparation on the Up-N-Down Transfer Kit, if you have not already done so:

1. With the 5 gallon Up-N-Down container in the vertical position, unscrew the plastic vent cap in the handle and pierce the plastic membrane over the vent boss under the cap to allow the container to vent.

Note: If your container does not have the vent cap and vent boss, drill a 3/16" hole in the handle. When you have finished delimiting you will be able to plug this drilled vent with the stainless steel screw that is supplied with the kit.

2. Remove the container's cap and cut the plastic membrane located in the 3/4" IPT opening in the cap. Take care to not damage the threads.
3. Find the 3/4" male adapter, apply teflon tape to the threaded end and screw it into the 3/4" IPT opening in the cap.
4. Put cap with male adapter back on the container and slide 3/4" hose over end of male adapter and fasten in place using hose clamp provided.

Delime using Flo-Jug Method

5. Slide the hose clamp over end of hose and slide hose over the male adapter in the water heater drain opening and secure in place using hose clamp.
6. Lift container to the "Pour" Position, see Figure 30, being careful to keep the vent in the handle above the liquid level and pour the UN•LIME into the heater.
7. Lower container, you may have to place the container on its empty carton to prevent the UN•LIME from flowing back into the container.
8. Let UN•LIME remain in the heater for 5 minutes and then lower the container to the "Drain" Position, see Figure 30.
9. Delimiting activity is indicated by foaming on the surface of the UN•LIME. If there is delimiting activity, repeat steps 6 thru 8.

Normally, lime removal will be completed within one hour. Severe build-up of lime may take longer than an hour to complete descaling.

Note: To check UN•LIME for continued use, place some scale or white chalk in a glass with a small amount of UN•LIME. If the material is vigorously dissolved by the UN•LIME, it can be reused; if not, the UN•LIME should be replaced.

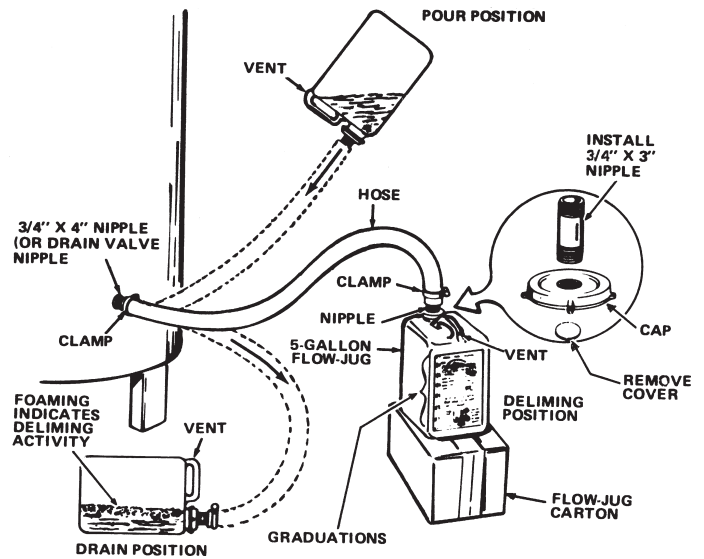
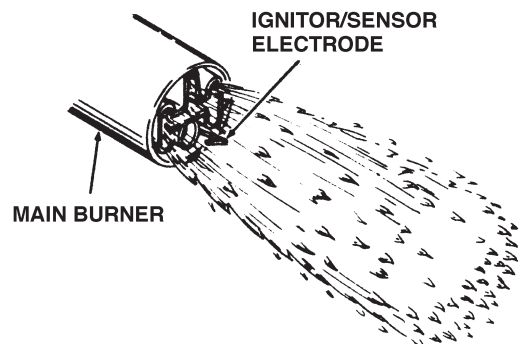

FIGURE 30.

POWER BURNER

Keep the area around the burner clear and free of combustible materials, gasoline or other flammable liquids or vapors. Do not obstruct burner air openings or ventilation grilles for combustion air.



TYPICAL MAIN BURNER FLAME
FIGURE 31.

The main burner flames (Figure 31) should be visually checked once a year for proper operation. This can be observed through the observation port on the burner housing. Burner flame should be blue. DO NOT use the observation port on the side of the tank to inspect the burner flame.

1. At least annually, contact a qualified service technician for a burner readjustment, cleaning and other than routine maintenance. Should the main burner or burner air openings require cleaning, remove the burner and clean with a soft brush. Clean main burner orifice with a suitable soft material.

GAS CONTROL VALVE

Figure 32 shows the combination gas control valves used on these heaters.

If gas control valve becomes defective, repairs should not be attempted. A new valve should be installed in place of defective one.

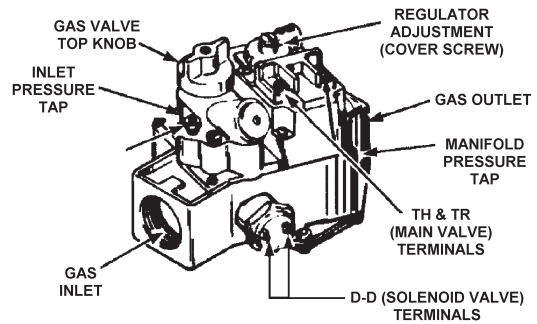

FIGURE 32.

SERVICE

The installer may be able to observe and correct certain problems which may arise when the unit is put into operation. HOWEVER, it is recommended that only a qualified service technician or qualified agencies, using appropriate test equipment, be allowed to service the heater.

As preliminary step, check wiring against diagram, check for grounded, broken or loose wires. Check all wire ends to be sure that they are making good contact.

ELECTRICAL SERVICING

LABEL ALL WIRES PRIOR TO DISCONNECTION WHEN SERVICING CONTROLS. WIRING ERRORS CAN CAUSE IMPROPER AND DANGEROUS OPERATION.

VERIFY PROPER OPERATION AFTER SERVICING.

TROUBLESHOOTING

⚠ WARNING

JUMPING OUT COMPONENTS AND/OR CIRCUITS DURING TROUBLESHOOTING CAN CAUSE SERIOUS PROBLEMS WITH THE POWER BURNER'S OPERATING SEQUENCE AND IGNITION SAFETY. IF YOU DO NOT HAVE THE PROPER TEST EQUIPMENT, I.E. A VOLT-OHM METER AND A MICRO-AMMETER DO NOT ATTEMPT TO TROUBLESHOOT OR REPAIR A. O. SMITH EQUIPMENT.

ALTERING THE IGNITION MODULE AND/OR CONTROL BOX WIRING IN ANY WAY COULD RESULT IN INTERNAL DAMAGE TO THE MODULE CIRCUITS, POSSIBLY ALTERING THE IGNITION SEQUENCE ALLOWING GAS VALVES TO OPEN BEFORE THE HOT SURFACE IGNITER IS UP TO IGNITION TEMPERATURE.

NOTE: ANY BYPASS OR ALTERATION OF UNITS SAFETIES WILL RESULT IN VOIDING APPLIANCE WARRANTY.

Before performing any troubleshooting familiarize yourself with the particular appliance. A. O. Smith power burners are supplied with Honeywell® ignition control systems and Robertshaw® gas control valves, see Figures 25 and 32.

Refer to the SEQUENCE OF OPERATION and burner exploded view, see Figure 22 and the wiring diagram located on page 24, and the troubleshooting section of burner manual before continuing.

Make sure the appliance is connected to a 120 Vac power supply, burner switch is "ON" and manual gas valve is in the "ON" position, and all electrical connections are secure before continuing to troubleshoot this appliance.

MOTOR WILL NOT RUN

1. Confirm 120 Vac. Also, to verify correct polarity, check for 120 Vac between black wire and G.

If there is no voltage, check for a loose connection or open switch at the high limit or thermostat.

2. If there is 120 volts between black wire and white wire, check for

loose connections or a locked rotor. If the rotor cannot be freed the motor and blower assembly must be replaced.

BURNER LOCKOUT ONCE IN A WHILE

Under this condition, the burner operates properly for days, and burner lockout occurs once in a while. The root causes for the burner occasional lockout include: (1) Gas inlet pressure too low; (2) Condensation over the ignitor area; (3) the pilot flame is too weak to light the main flame reliably; (4) the pilot air/gas ratio is out of range causing pilot flame to be unreliable.

1. Turn burner switch to "OFF" position and turn off the main gas valve (Robertshaw®).
2. Install manometers for gas inlet pressure, manifold pressure, and pilot gas pressure, see Figure 32 for the pressure ports location).
3. Check for the gas inlet pressure, reset the service regulator (if required) to get 8" w.c. (2.0 kPa) - 10" w.c. (2.4 kPa) inlet pressure while the burner is in the "OFF" position.
4. Turn the burner "ON",
 - Take blower pressure at the pressure port during the purge cycle, see Figure 25 for location.
 - Take the pilot gas pressure at the same pressure port during the ignition period (following 45 seconds purge cycle).
 - The pilot gas pressure should be 0.6" - 0.9" w.c. higher than blower pressure, if not, adjust the pilot gas regulator (during the ignition cycle, see Figure 25).
 - If burner lights on during the ignition cycle, cycle the unit on/off several times to ensure pilot system is reliable. Turn off the burner, then follow Step 6.
5. Turn the burner "OFF", follow burner manual instructions to remove the pilot assembly (also refer to Figure 25 in this manual) and procedures to check pilot assembly. Items to check for the pilot system include:
 - Check for condensation over ignitor area.
 - Check for the ignitor gap (1/8" - 3/16").
 - Check for the thermal cutoff continuity by ohm meter, replace it if the thermal cutoff is open.
 - Check for the low gas pressure switch by ohm meter (while pilot gas pressure is 7" w.c. [1.7 kPa] or higher).

- Check for the continuity between the flame rod and sensor connection at Honeywell flame control module by the ohm meter.
 - Check for ignitor wire connections and spark leakage (call AOS service center for steps of spark leakage checking).
 - Following burner manual instructions to re-install the pilot assembly.
6. Turn on the Robertshaw gas valve, turn the burner switch to “ON” position. Cycle the heater ON/OFF several times to ensure the problem is solved.

MOTOR RUNS CONTINUOUSLY, PREPURGE TIME ELAPSES BUT MAIN FLAME NOT ESTABLISHED (BURNER LIGHT NEVER ON)

1. When the heater is first installed, gas line must be purged properly prior to start-up. This heater is equipped with a flame control module that only allows one “trial for ignition” for 15 seconds and locks out if no flame signal is detected. For initial start-up, two or more resets may be required to ensure that all the air has been purged from the gas pilot line. To reset the heater, turn the burner power switch to “OFF” position for at least one minute, then turn it back “ON”.
 2. Check for gas supply line manual valves in “ON” position, and line pressure. Make sure the pilot manual gas cock (nearby the main gas valve) is fully open.
 3. After the 45-seconds prepurge cycle, the pilot gas valve (mounted on the panel) “click” sound should be heard. If you hear the pilot gas energized, proceed to Step 5.
 4. Check 24 Vac control circuit in the following systematic approach:
 - Check for 24V between “24V” and “GND” of Honeywell Flame Control Module, which is located inside the burner control panel. If voltage is OK, proceed to Step 5.
 - If there’s no voltage, check for 24V between the air switch “COM” terminal and GND (the air switch is mounted on the control panel, the switch cover needs to be removed to access the wiring terminal “COM” and “NO”). If there’s no 24 V, check for a loose connection between the 24V transformer and air switch, or a defective transformer.
 - If there’s 24V at “COM” terminal, check for 24V between the air switch terminal “NO” (normally open) and GND. If there’s no 24V, the air switch pressure may be set too high or a defective air switch or loose connections of pressure sensing tubings. To lower the air switch setting, make sure the blower is running and blower wheel and air inlet are free from dirt, counterclockwise turn the switch setting-screw until the switch is closed. Call the A.O. Smith Technical Center before you reset the switch.
 - If there’s 24V at “NO” terminal of the air switch, check for 24V at the air intake pressure switch connectors, (this switch is only supplied for direct vent systems). If there’s no 24V at the switch connectors, check for loose connections, air intake blockage, or a defective air switch.
 - Do not proceed to Step 5 unless 24V is detected at “24V” terminal of the Honeywell Module.
 5. As soon as the pilot gas valve is energized, check for the burner pilot flame through the burner peek-hole. If the pilot flame is established inside the burner, then proceed to Step 6.
 - Turn the burner switch to “OFF” position for at least one minute to reset the heater.
 - Check for 24V between “PV” terminal and “MV/PV” terminal after 45 seconds prepurge cycle (this 24V may only last 15 seconds starting after 45S prepurge). If there’s no 24V at the “PV” terminal ever, and there’s 24V at “24V” terminal, the Honeywell flame control module needs to be replaced.
- If 24V is detected for a period of 15 seconds, check for the changes of gas supply line pressure when the pilot gas valve is energized. If no visible pressure change during the pilot ignition period, check for loose connection of the pilot valve or a defective pilot gas valve.
 - Adjust the pilot gas regulator setting during the pilot ignition period (15 seconds window). Do not set too much or too little pilot gas. This adjustment should only be performed during the 15 seconds ignition period. A clockwise or counter-clockwise 0.5 to 1 turn should be able to correct the problem. Refer to burner manual for detailed pilot gas setting procedure.
 - If still no pilot flame inside the burner, check for the spark ignitor wiring, ignitor tip location and visually check the spark (burner pilot assembly needs to be taken out for the visual check). Refer to the burner manual for detailed spark ignition troubleshooting procedures.
6. Pilot flame established but not detected by the flame control module. Use Micro Amp meter to measure flame signal during the pilot ignition period. Refer to burner manual for testing procedures.
 - If pilot flame is confirmed visually through the burner peek hole, and the flame signal is zero, the thermal-cutoff safety switch (mounted nearby the flame rod, inside the burner mixing chamber) may be broken or check for loose wire connections or low gas switch (mounted inside control panel) may be broken. If the thermal cutoff switch or low gas switch is broken (by checking the switch continuity), the switches must be replaced before the heater can operate again.
 - If it’s confirmed that the thermal cutoff switch is damaged (open), call the A.O. Smith Technical Center to analyze the root cause (too lean combustion) and proper gas/air ratio adjustment. Flashback will cause the thermal cutoff switch to be broken (open).
 - If the flame signal is not zero but below 1 μ A, relocate flame rod or replace flame rod will be required. Refer to burner manual for detailed procedure of replacing flame rod.

MOTOR RUNS CONTINUOUSLY, BURNER LIGHTS ON MOMENTARILY THEN LOCKS OUT OR EXCESSIVE ON/OFF CYCLE

Under this condition, the burner will start the purge cycle again, then pilot ignition and main flame cycle. If main flame cannot be sustained:

1. Make sure main manual gas valve (right after the Robertshaw gas valve) is fully open;
2. Check for 24V at the Robertshaw gas valve when the main gas light is on. If there’s no 24V at the valve, check loose wire connection.
3. Check for gas supply line pressure. The gas line pressure before the valve should be maintained at minimum 8” w.c. when main flame is “ON”. If the gas line pressure drops below 8” w.c. (2 kPa), the service regulator pressure setting must be increased to keep 8” w.c. (2 kPa) minimum gas pressure. After adjusting the gas regulator setting, turn off the heater, make sure the gas line pressure does not exceed 14” w.c. (3.5 kPa) if it does exceed 14” w.c. (3.5 kPa) static pressure, the gas supply line size must be increased accordingly to avoid gas line pressure exceeding 14” w.c. (3.5 kPa)
4. Check the gas valve manifold pressure (refer to Table 10), see ADJUSTMENT PROCEDURE to adjust the manifold pressure.
5. Check for defective gas valve for failing to open or shut off.
6. Verify that the air supply is adequate. The air inlet screen or blower wheel may be restricted.
7. Check the installation for proper ventilation, see AIR REQUIREMENTS.

8. Verify the air switch setting is not too high.
9. Check the venting system for the correct sizing, excessive or insufficient draft, and proper operation of the barometric draft control, see VENTING.

NOISY BURNER OPERATION

1. Check for flue gas excess O₂ or CO₂ reading (refer to Table 3). If combustion is too lean (flue gas O₂ reads more than 7.5%), the combustion flame front may not be stable, which will cause noisy operation. See ADJUSTMENT.
2. Check the venting system for the correct sizing, excess or insufficient draft, and proper operation of the barometric draft control, see VENTING.
3. If the burner operation is still noisy, then remove the burner, examine the burner diffuser, blast-tube tip, anti-flashback corrugated tube, center mixing, refer to the burner manual for details.

GAS FAILS TO SHUT OFF

Check for defective gas valve or thermostat. If operation is incorrect, replace.

REPLACEMENT PARTS

Replacement parts may be ordered through A. O. Smith dealers, unauthorized servicers or distributors. Refer to the Yellow Pages for where to call or contact A.O. Smith, 500 Tennessee Waltz Parkway, Ashland City, TN 37015, 1-800-433-2545 or visit our website at www.aosmithwaterheaters.com When ordering parts be sure to state the quantity, part number and description of the items including the complete model and serial number as it appears on the product. Refer to the parts list for more information.

FOR YOUR INFORMATION

START UP CONDITIONS

SMOKE/ODOR

It is not uncommon to experience a small amount of smoke and odor during the initial start-up. This is due to burning off of oil from metal parts, and will disappear in a short while.

STRANGE SOUNDS

Possible noises due to expansion and contraction of some metal parts during periods of heat-up and cool-down do not necessarily represent harmful or dangerous conditions.

Condensation causes sizzling and popping within the burner area during heating and cooling periods and should be considered normal. See "Condensation" section in this manual.

CONDENSATION

Whenever the water heater is filled with cold water, some condensate will form while the burner is on. A water heater may appear to be leaking when in fact the water is condensation. This usually happens when:

- a. A new water heater is filled with cold water for the first time.
- b. Burning gas produces water vapor in water heaters, particularly high efficiency models where flue temperatures are lower.
- c. Large amounts of hot water are used in a short time and the refill water in the tank is very cold.

Moisture from the products of combustion condense on the cooler tank surfaces and form drops of water which may fall onto the burner or other hot surfaces to produce a "sizzling" or "frying" noise.

OPERATIONAL CONDITIONS

HOT WATER ODOR

In each water heater there is installed at least one anode rod for corrosion protection of the tank. Certain water conditions will cause a reaction between this rod and the water. The most common complaint associated with the anode rod is one of a "rotten egg smell" in the hot water. The smell is a result of four factors which must all be present for the odor to develop:

- a. A concentration of sulfate in the supply water.
- b. Little or no dissolved oxygen in the water.

- c. A sulfate reducing bacteria which has accumulated within the water heater (this harmless bacteria is nontoxic to humans).
- d. An excess of active hydrogen in the tank. This is caused by the corrosion protective action of the anode rod.

Smelly water may be eliminated or reduced in some water heater models by replacing the anode rod(s) with one of less active material, and then chlorinating water heater tank and all water lines.

Contact the local water heater supplier or service agency for further information concerning an Anode Rod Replacement Kit and this chlorination treatment.

If smelly water persists after anode rod replacement and chlorination treatment, we can only suggest that chlorination or aeration of the water supply be considered to eliminate the water problem.

Do not remove the anode rod leaving the tank unprotected. By doing so, all warranty on the water heater tank is voided.

"AIR" IN HOT WATER FAUCETS

HYDROGEN GAS: Hydrogen gas can be produced in a hot water system that has not been used for a long period of time (generally two weeks or more). Hydrogen gas is extremely flammable and explosive. To prevent the possibility of injury under these conditions, we recommend the hot water faucet, located farthest away, be opened for several minutes before any electrical appliances which are connected to the hot water system are used (such as a dishwasher or washing machine). If hydrogen gas is present, there will probably be an unusual sound similar to air escaping through the pipe as the hot water faucet is opened. There must be no smoking or open flame near the faucet at the time it is open.









HIGH WATER TEMPERATURE SHUT OFF SYSTEM

This water heater is equipped with a manual reset type high limit (Energy Cutout) switch. The high limit switch interrupts the main burner gas flow should water temperature reach 203°F (95°C).

In the event of high limit switch operation, the water heater cannot be restarted unless the water temperature is reduced to approximately 120F (49C). The high limit reset button on the front of the thermostat then needs to be depressed. See Figure 2 for the location of the reset button.

WATER PIPING DIAGRAMS

LEGEND

	TEMPERATURE & PRESSURE RELIEF VALVE		FULL PORT BALL VALVE
	PRESSURE RELIEF VALVE		CHECK VALVE
	CIRCULATING PUMP		TEMPERATURE GAGE
	TANK TEMPERATURE CONTROL		WATER FLOW SWITCH
	DRAIN		

MULTI FLUE - (1 UNIT) WITH VERTICAL STORAGE TANK



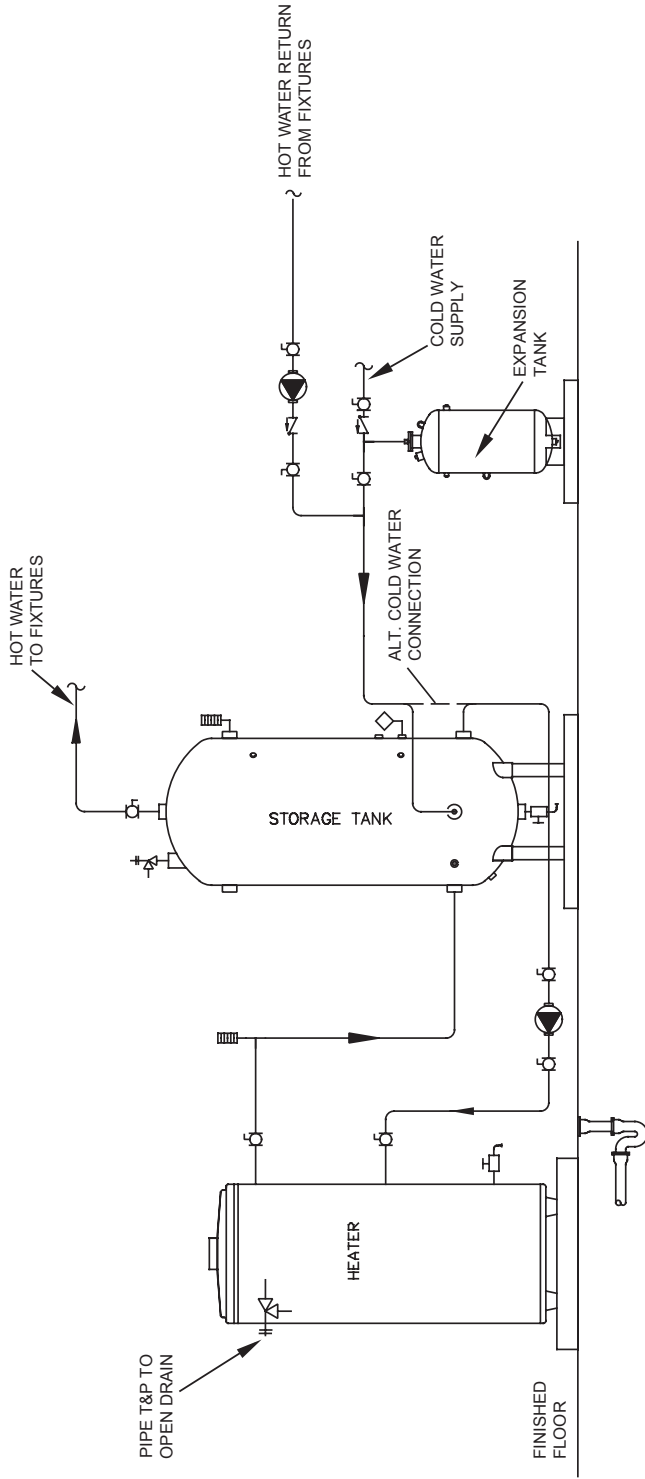





WARNING: THIS DRAWING SHOWS SUGGESTED PIPING CONFIGURATION AND OTHER DEVICES; CHECK WITH LOCAL CODES AND ORDINANCES FOR ADDITIONAL REQUIREMENTS.



NOTES:

1. Preferred piping diagram.
2. The temperature and pressure relief valve setting shall not exceed pressure rating of any component in the system.
3. Service valves are shown for servicing unit. However, local codes shall govern their usage.
4. The Tank Temperature Control should be wired to and control the pump between the water heater(s) and the storage tank(s).
5. The water heater's operating thermostat should be set 5 degrees F higher than the Tank Temperature Control.

LEGEND

	TEMPERATURE & PRESSURE RELIEF VALVE		FULL PORT BALL VALVE
	PRESSURE RELIEF VALVE		CHECK VALVE
	CIRCULATING PUMP		TEMPERATURE GAGE
	TANK TEMPERATURE CONTROL		WATER FLOW SWITCH
	DRAIN		

MULTI FLUE - (1 UNIT) WITH HORIZONTAL STORAGE TANK

WARNING: THIS DRAWING SHOWS SUGGESTED PIPING CONFIGURATION AND OTHER DEVICES; CHECK WITH LOCAL CODES AND ORDINANCES FOR ADDITIONAL REQUIREMENTS.

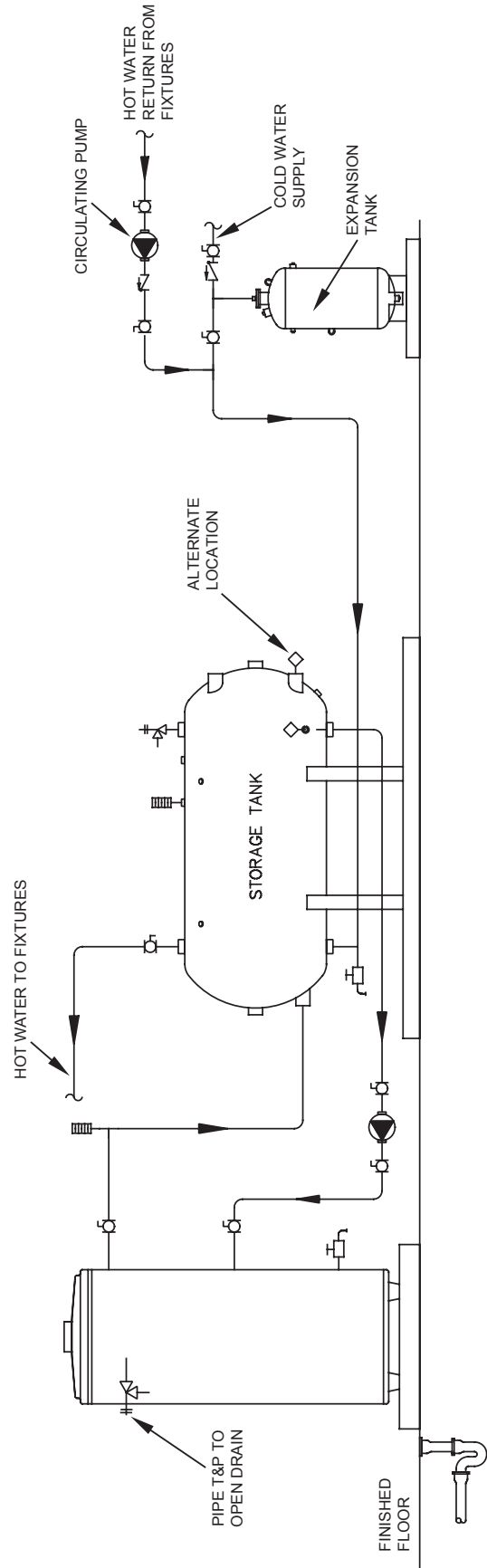

NOTES:

1. Preferred piping diagram.
2. The temperature and pressure relief valve setting shall not exceed pressure rating of any component in the system.
3. Service valves are shown for servicing unit. However, local codes shall govern their usage.
4. The Tank Temperature Control should be wired to and control the pump between the water heater(s) and the storage tank(s).
5. The water heater's operating thermostat should be set 5 degrees F higher than the Tank Temperature Control.

MULTI FLUE - (1 UNIT) WITH MIXING VALVE TWO TEMPERATURE

WARNING: THIS DRAWING SHOWS SUGGESTED PIPING CONFIGURATION AND OTHER DEVICES; CHECK WITH LOCAL CODES AND ORDINANCES FOR ADDITIONAL REQUIREMENTS.

LEGEND

- TEMPERATURE & PRESSURE RELIEF VALVE
- PRESSURE RELIEF VALVE
- CIRCULATING PUMP
- TANK TEMPERATURE CONTROL
- DRAIN
- FULL PORT BALL VALVE
- CHECK VALVE
- TEMPERATURE GAGE
- WATER FLOW SWITCH

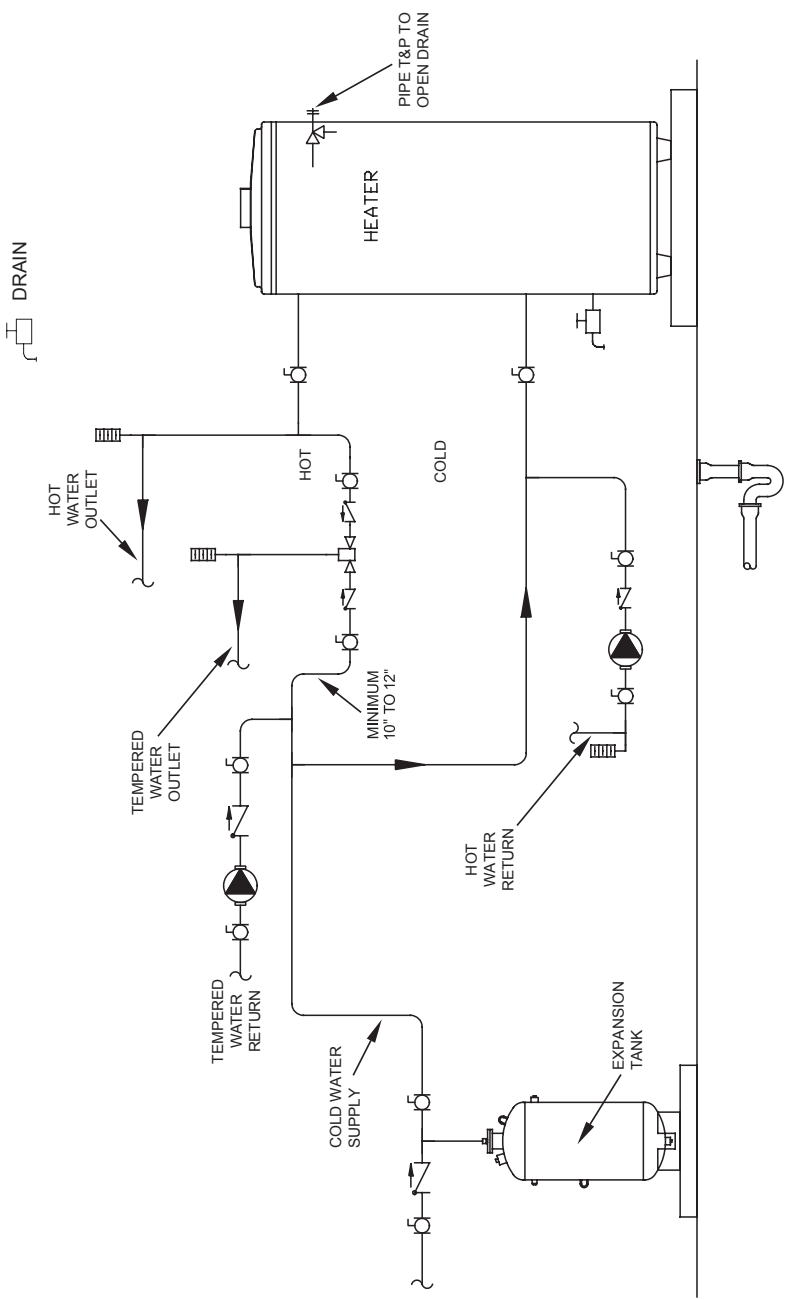

- NOTES:**
1. Preferred piping diagram.
 2. The temperature and pressure relief valve setting shall not exceed pressure rating of any component in the system.
 3. Service valves are shown for servicing unit. However, local codes shall govern their usage.

LEGEND

- TEMPERATURE & PRESSURE RELIEF VALVE
- PRESSURE RELIEF VALVE
- CIRCULATING PUMP
- TANK TEMPERATURE CONTROL
- DRAIN
- FULL PORT BALL VALVE
- CHECK VALVE
- TEMPERATURE GAGE
- WATER FLOW SWITCH

MULTI FLUE - (2 UNITS)



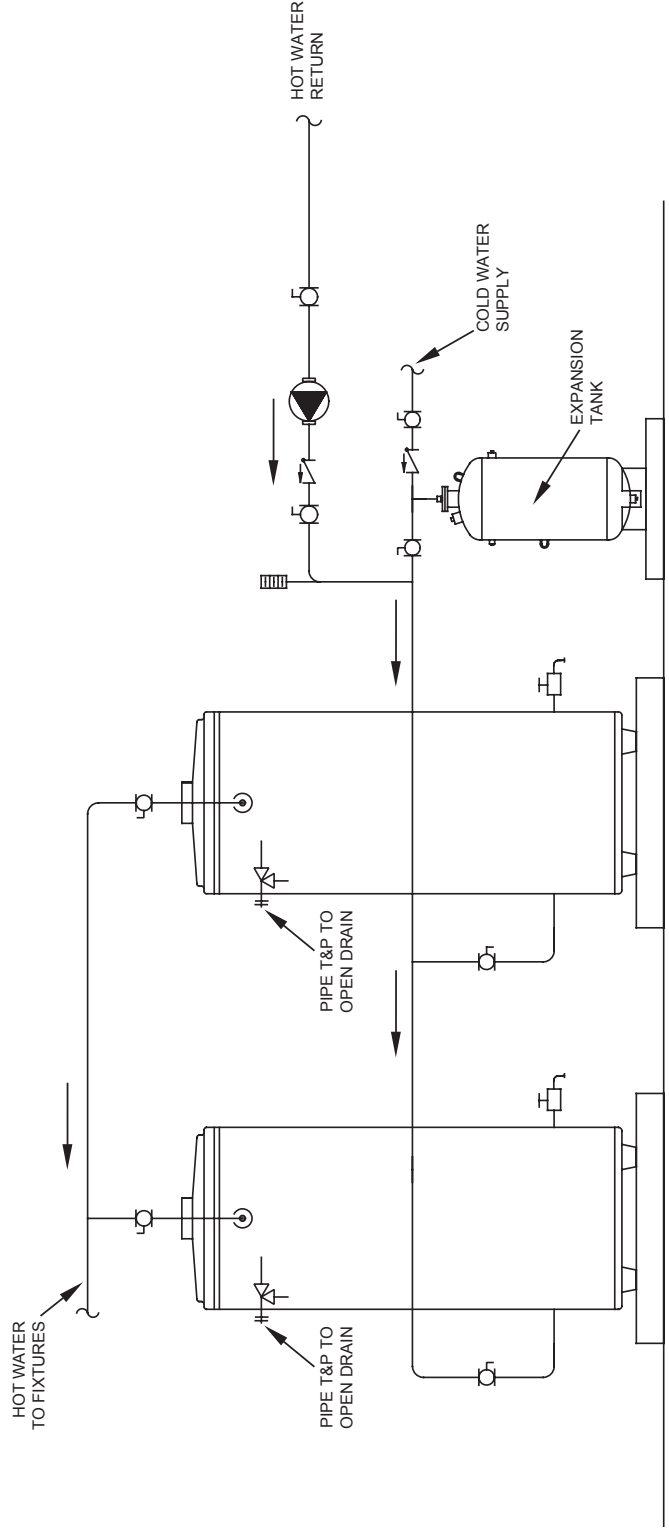





WARNING: THIS DRAWING SHOWS SUGGESTED PIPING CONFIGURATION AND OTHER DEVICES; CHECK WITH LOCAL CODES AND ORDINANCES FOR ADDITIONAL REQUIREMENTS.



NOTES:

1. Preferred piping diagram.
2. The temperature and pressure relief valve setting shall not exceed pressure rating of any component in the system.
3. Service valves are shown for servicing unit. However, local codes shall govern their usage.

LEGEND

	TEMPERATURE & PRESSURE RELIEF VALVE		FULL PORT BALL VALVE
	PRESSURE RELIEF VALVE		CHECK VALVE
	CIRCULATING PUMP		TEMPERATURE GAGE
	TANK TEMPERATURE CONTROL		WATER FLOW SWITCH
	DRAIN		

MULTI FLUE - (2 UNITS) WITH VERTICAL STORAGE TANK

WARNING: THIS DRAWING SHOWS SUGGESTED PIPING CONFIGURATION AND OTHER DEVICES; CHECK WITH LOCAL CODES AND ORDINANCES FOR ADDITIONAL REQUIREMENTS.

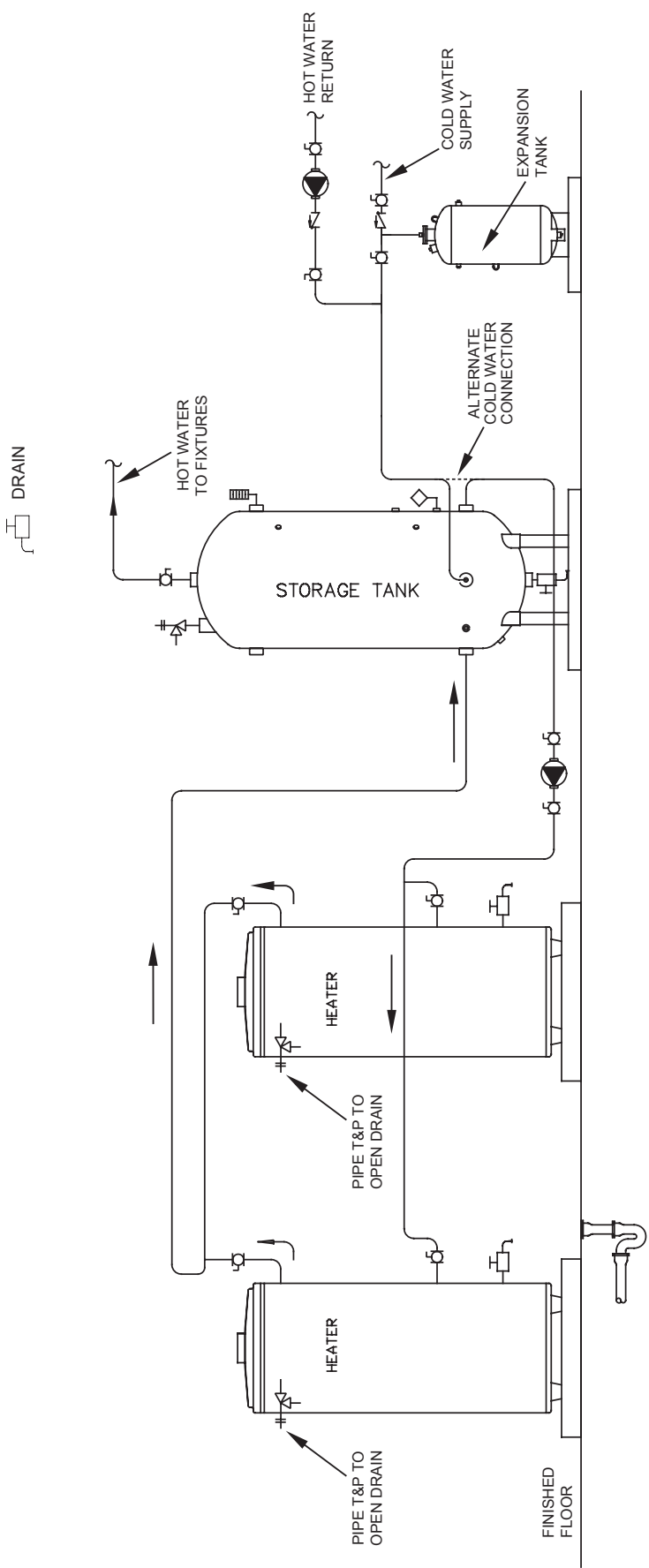

NOTES:

1. Preferred piping diagram.
2. The temperature and pressure relief valve setting shall not exceed pressure rating of any component in the system.
3. Service valves are shown for servicing unit. However, local codes shall govern their usage.
4. The Tank Temperature Control should be wired to and control the pump between the water heater(s) and the storage tank(s).
5. The water heater's operating thermostat should be set 5 degrees F higher than the Tank Temperature Control.

MULTI FLUE - (2 UNITS) WITH VERTICAL STORAGE TANK

WARNING: THIS DRAWING SHOWS SUGGESTED PIPING CONFIGURATION AND OTHER DEVICES; CHECK WITH LOCAL CODES AND ORDINANCES FOR ADDITIONAL REQUIREMENTS.

LEGEND



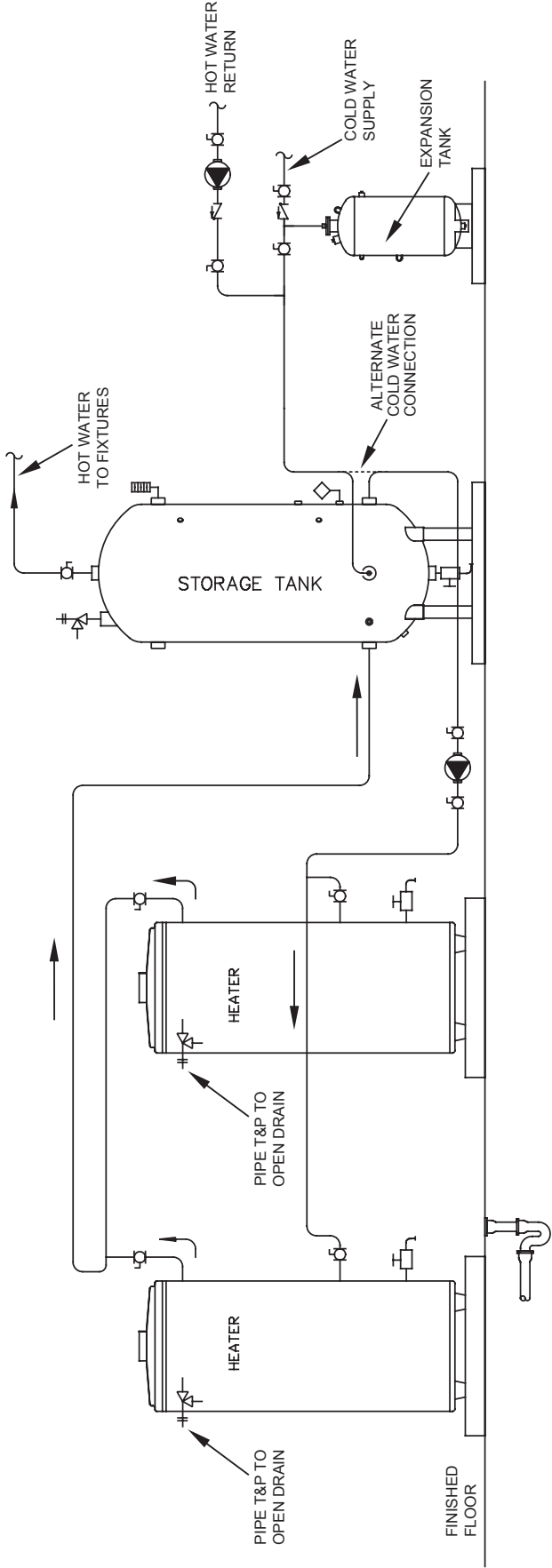





- TEMPERATURE & PRESSURE RELIEF VALVE
- PRESSURE RELIEF VALVE
- CIRCULATING PUMP
- TANK TEMPERATURE CONTROL
- DRAIN
- FULL PORT BALL VALVE
- CHECK VALVE
- TEMPERATURE GAGE
- WATER FLOW SWITCH



NOTES:

1. Preferred piping diagram.
2. The temperature and pressure relief valve setting shall not exceed pressure rating of any component in the system.
3. Service valves are shown for servicing unit. However, local codes shall govern their usage.
4. The Tank Temperature Control should be wired to and control the pump between the water heater(s) and the storage tank(s).
5. The water heater's operating thermostat should be set 5 degrees F higher than the Tank Temperature Control.

LEGEND

	TEMPERATURE & PRESSURE RELIEF VALVE		FULL PORT BALL VALVE
	PRESSURE RELIEF VALVE		CHECK VALVE
	CIRCULATING PUMP		TEMPERATURE GAGE
	TANK TEMPERATURE CONTROL		WATER FLOW SWITCH
	DRAIN		

MULTI FLUE - (2 UNITS) WITH HORIZONTAL STORAGE TANK

WARNING: THIS DRAWING SHOWS SUGGESTED PIPING CONFIGURATION AND OTHER DEVICES; CHECK WITH LOCAL CODES AND ORDINANCES FOR ADDITIONAL REQUIREMENTS.

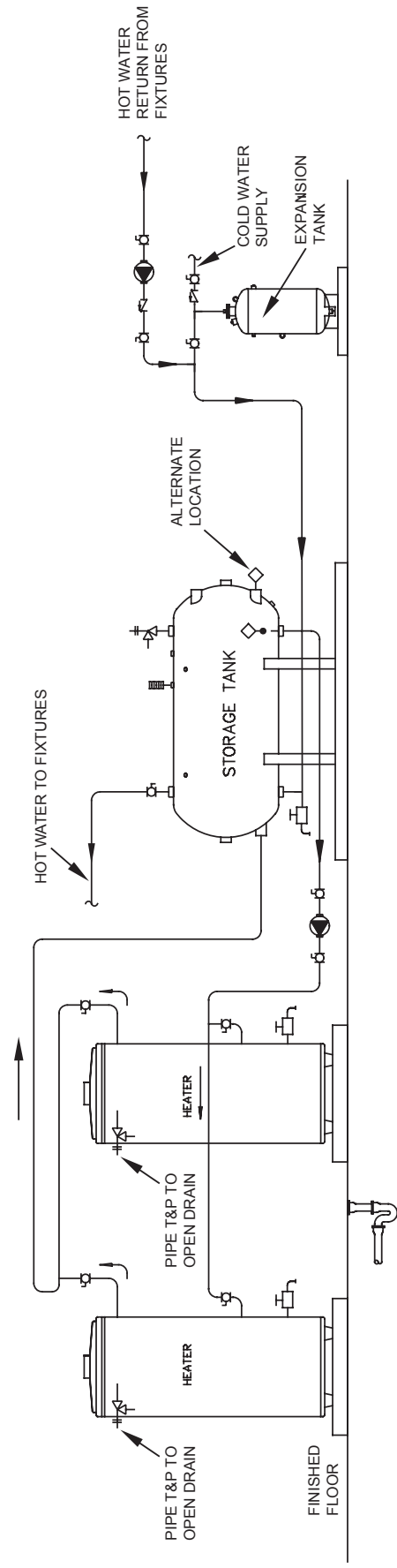

NOTES:

1. Preferred piping diagram.
2. The temperature and pressure relief valve setting shall not exceed pressure rating of any component in the system.
3. Service valves are shown for servicing unit. However, local codes shall govern their usage.
4. The Tank Temperature Control should be wired to and control the pump between the water heater(s) and the storage tank(s).
5. The water heater's operating thermostat should be set 5 degrees F higher than the Tank Temperature Control.

MULTI FLUE (2 UNITS) TWO TEMPERATURE

WARNING: THIS DRAWING SHOWS SUGGESTED PIPING CONFIGURATION AND OTHER DEVICES; CHECK WITH LOCAL CODES AND ORDINANCES FOR ADDITIONAL REQUIREMENTS.





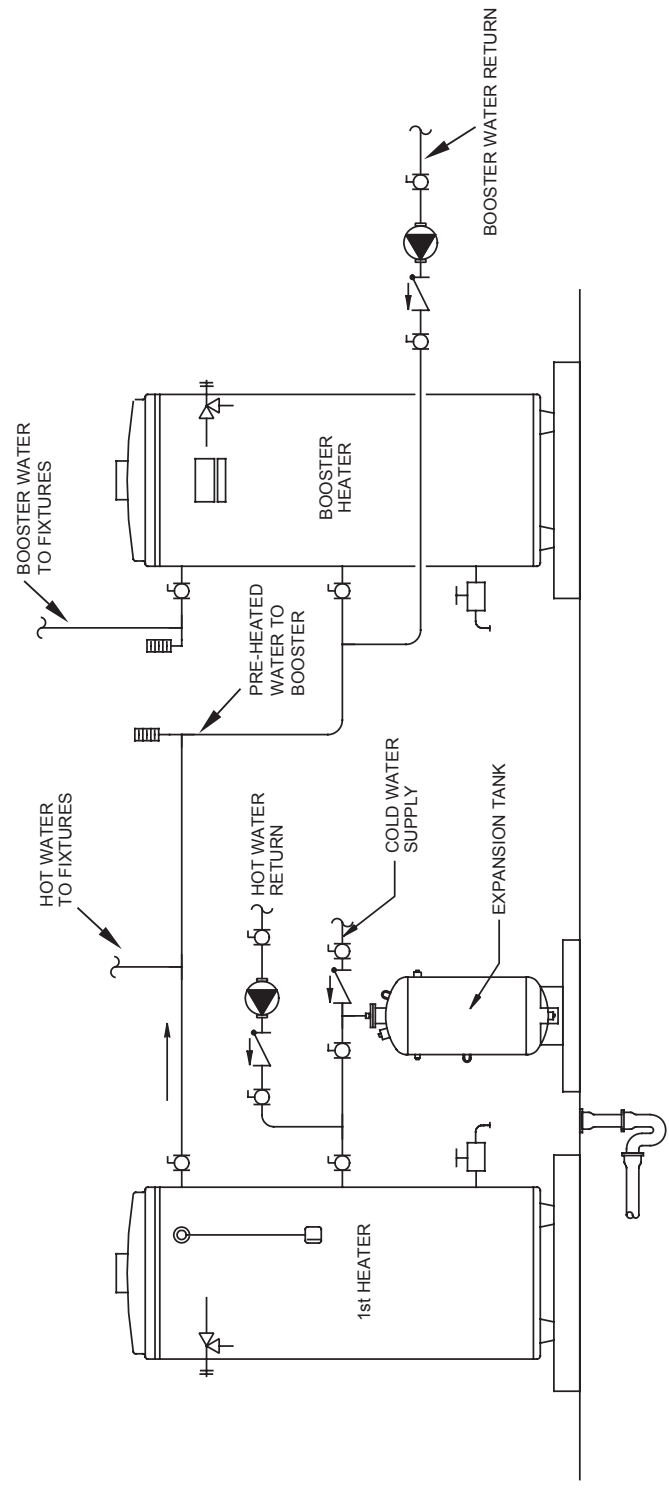



LEGEND

- TEMPERATURE & PRESSURE RELIEF VALVE
- PRESSURE RELIEF VALVE
- CIRCULATING PUMP
- TANK TEMPERATURE CONTROL
- DRAIN
- FULL PORT BALL VALVE
- CHECK VALVE
- TEMPERATURE GAGE
- WATER FLOW SWITCH



- NOTES:**
1. Preferred piping diagram.
 2. The temperature and pressure relief valve setting shall not exceed pressure rating of any component in the system.
 3. Service valves are shown for servicing unit. However, local codes shall govern their usage.

LEGEND

	TEMPERATURE & PRESSURE RELIEF VALVE		FULL PORT BALL VALVE
	PRESSURE RELIEF VALVE		CHECK VALVE
	CIRCULATING PUMP		TEMPERATURE GAGE
	TANK TEMPERATURE CONTROL		WATER FLOW SWITCH
	DRAIN		

MULTI FLUE (2 UNITS) WITH BOOSTER TWO TEMPERATURE



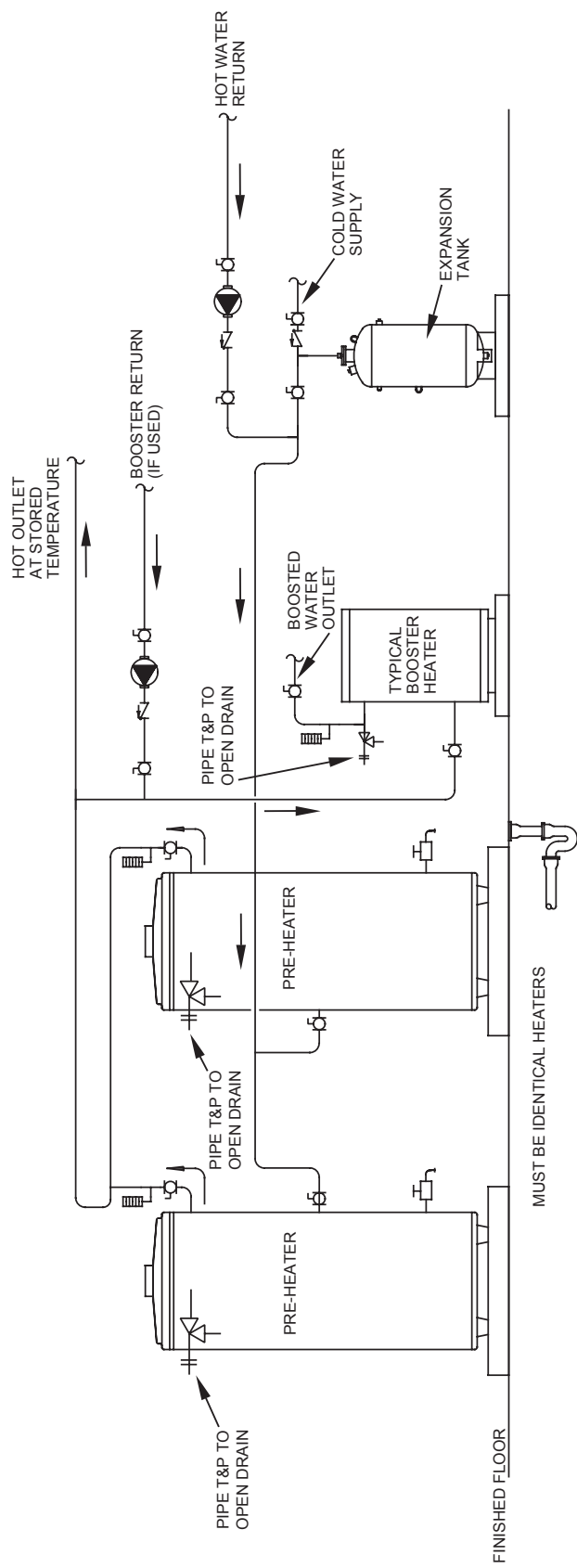





WARNING: THIS DRAWING SHOWS SUGGESTED PIPING CONFIGURATION AND OTHER DEVICES; CHECK WITH LOCAL CODES AND ORDINANCES FOR ADDITIONAL REQUIREMENTS.



NOTES:

1. Preferred piping diagram.
2. The temperature and pressure relief valve setting shall not exceed pressure rating of any component in the system.
3. Service valves are shown for servicing unit. However, local codes shall govern their usage.

LEGEND

	TEMPERATURE & PRESSURE RELIEF VALVE		FULL PORT BALL VALVE
	PRESSURE RELIEF VALVE		CHECK VALVE
	CIRCULATING PUMP		TEMPERATURE GAGE
	TANK TEMPERATURE CONTROL		WATER FLOW SWITCH
	DRAIN		

MULTI-FLUE (3 UNITS)



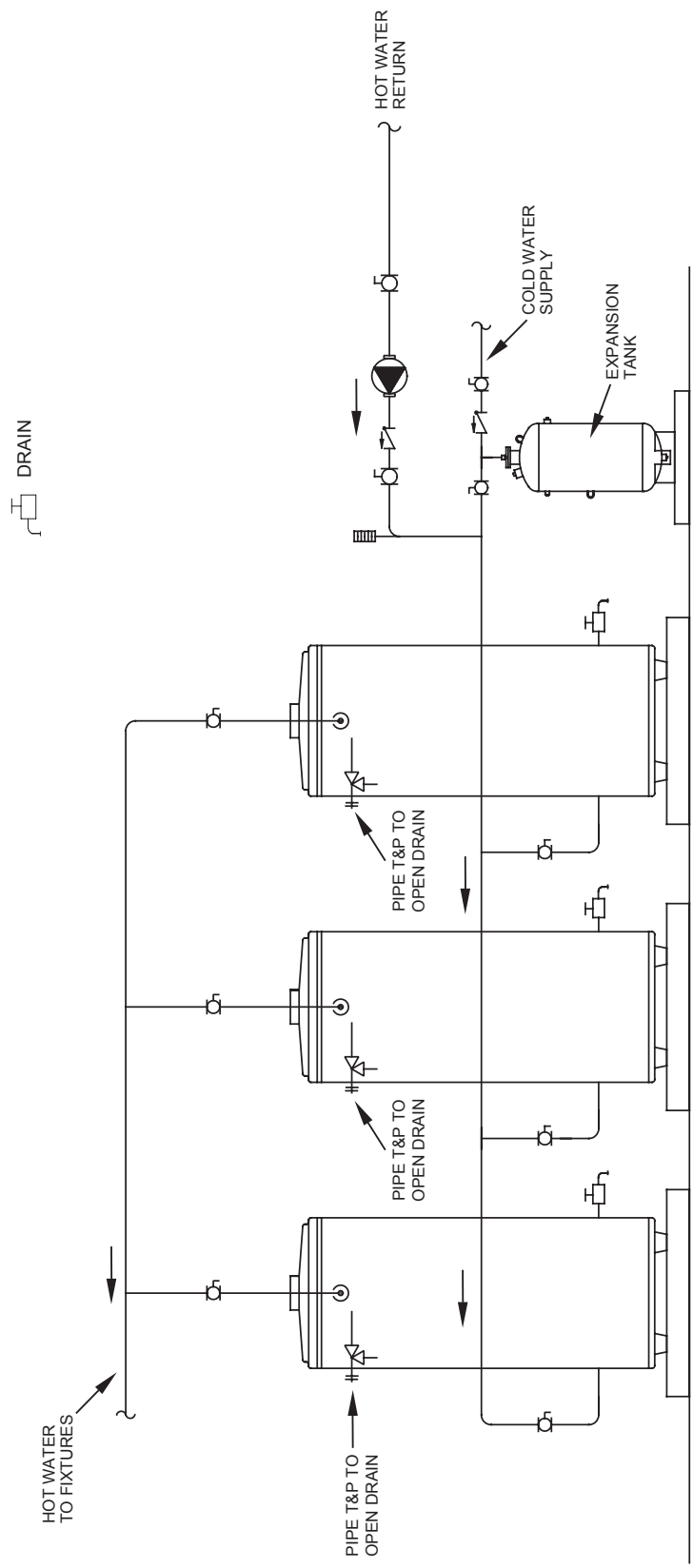





WARNING: THIS DRAWING SHOWS SUGGESTED PIPING CONFIGURATION AND OTHER DEVICES; CHECK WITH LOCAL CODES AND ORDINANCES FOR ADDITIONAL REQUIREMENTS.



NOTES:

1. Preferred piping diagram.
2. The temperature and pressure relief valve setting shall not exceed pressure rating of any component in the system.
3. Service valves are shown for servicing unit. However, local codes shall govern their usage.

LEGEND

	TEMPERATURE & PRESSURE RELIEF VALVE		FULL PORT BALL VALVE
	PRESSURE RELIEF VALVE		CHECK VALVE
	CIRCULATING PUMP		TEMPERATURE GAGE
	TANK TEMPERATURE CONTROL		WATER FLOW SWITCH
	DRAIN		

MULTI-FLUE (3 UNITS) WITH VERTICAL STORAGE TANK



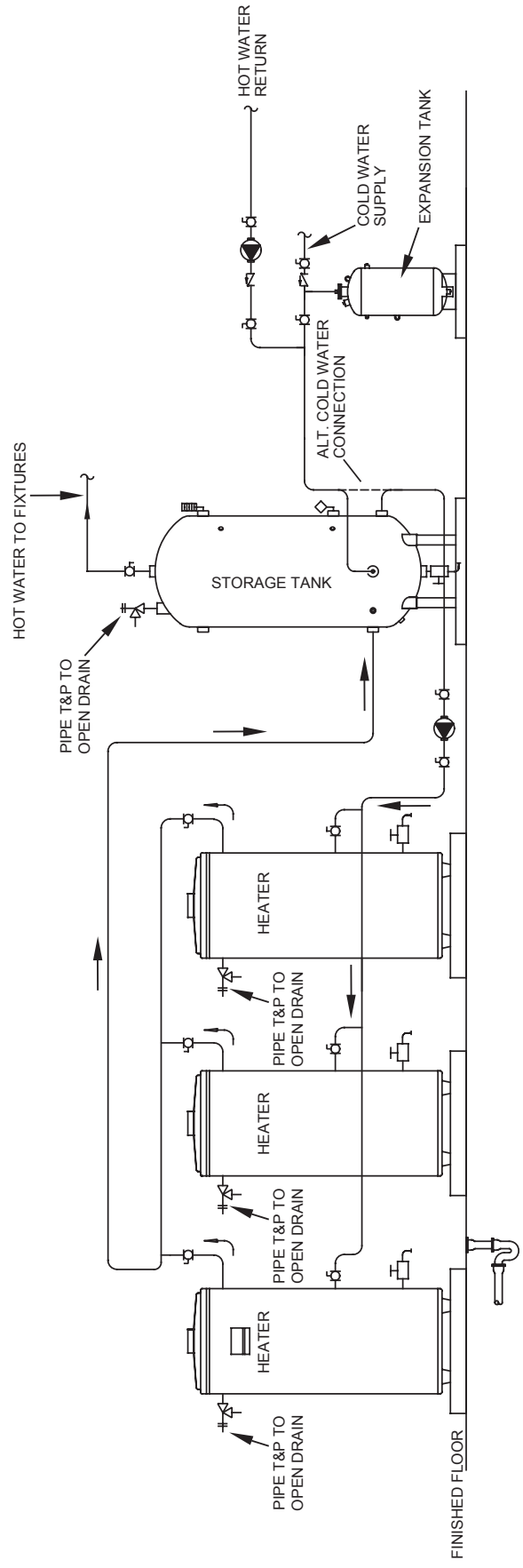





WARNING: THIS DRAWING SHOWS SUGGESTED PIPING CONFIGURATION AND OTHER DEVICES; CHECK WITH LOCAL CODES AND ORDINANCES FOR ADDITIONAL REQUIREMENTS.



NOTES:

1. Preferred piping diagram.
2. The temperature and pressure relief valve setting shall not exceed pressure rating of any component in the system.
3. Service valves are shown for servicing unit. However, local codes shall govern their usage.
4. The Tank Temperature Control should be wired to and control the pump between the water heater(s) and the storage tank(s).
5. The water heater's operating thermostat should be set 5 degrees F higher than the Tank Temperature Control.

LEGEND

	TEMPERATURE & PRESSURE RELIEF VALVE		FULL PORT BALL VALVE
	PRESSURE RELIEF VALVE		CHECK VALVE
	CIRCULATING PUMP		TEMPERATURE GAGE
	TANK TEMPERATURE CONTROL		WATER FLOW SWITCH
	DRAIN		

MULTI-FLUE (3 UNITS) WITH HORIZONTAL STORAGE TANK



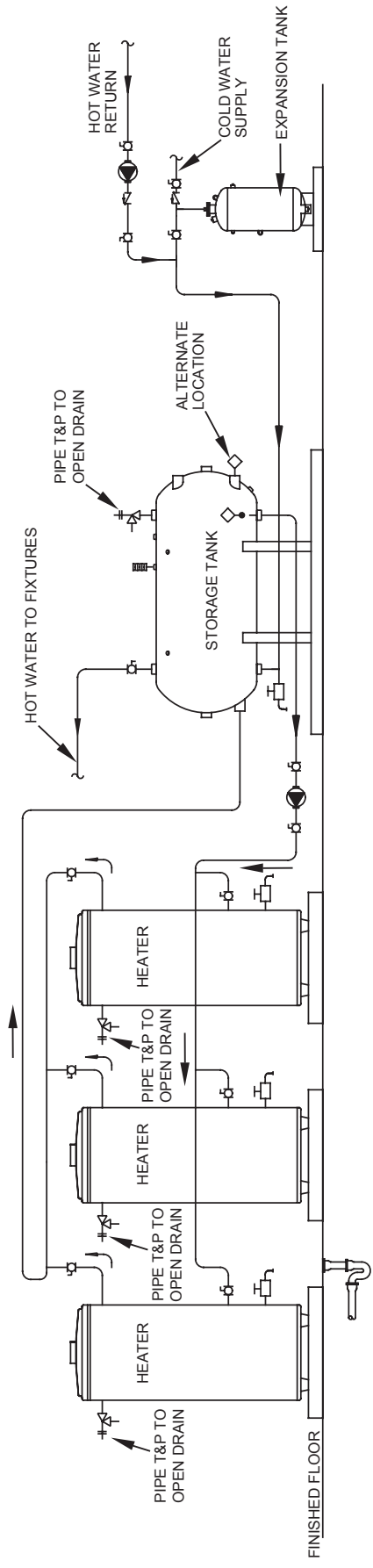





WARNING: THIS DRAWING SHOWS SUGGESTED PIPING CONFIGURATION AND OTHER DEVICES; CHECK WITH LOCAL CODES AND ORDINANCES FOR ADDITIONAL REQUIREMENTS.



NOTES:

1. Preferred piping diagram.
2. The temperature and pressure relief valve setting shall not exceed pressure rating of any component in the system.
3. Service valves are shown for servicing unit. However, local codes shall govern their usage.
4. The Tank Temperature Control should be wired to and control the pump between the water heater(s) and the storage tank(s).
5. The water heater's operating thermostat should be set 5 degrees F higher than the Tank Temperature Control.

LEGEND

	TEMPERATURE & PRESSURE RELIEF VALVE		FULL PORT BALL VALVE
	PRESSURE RELIEF VALVE		CHECK VALVE
	CIRCULATING PUMP		TEMPERATURE GAGE
	TANK TEMPERATURE CONTROL		WATER FLOW SWITCH
	DRAIN		





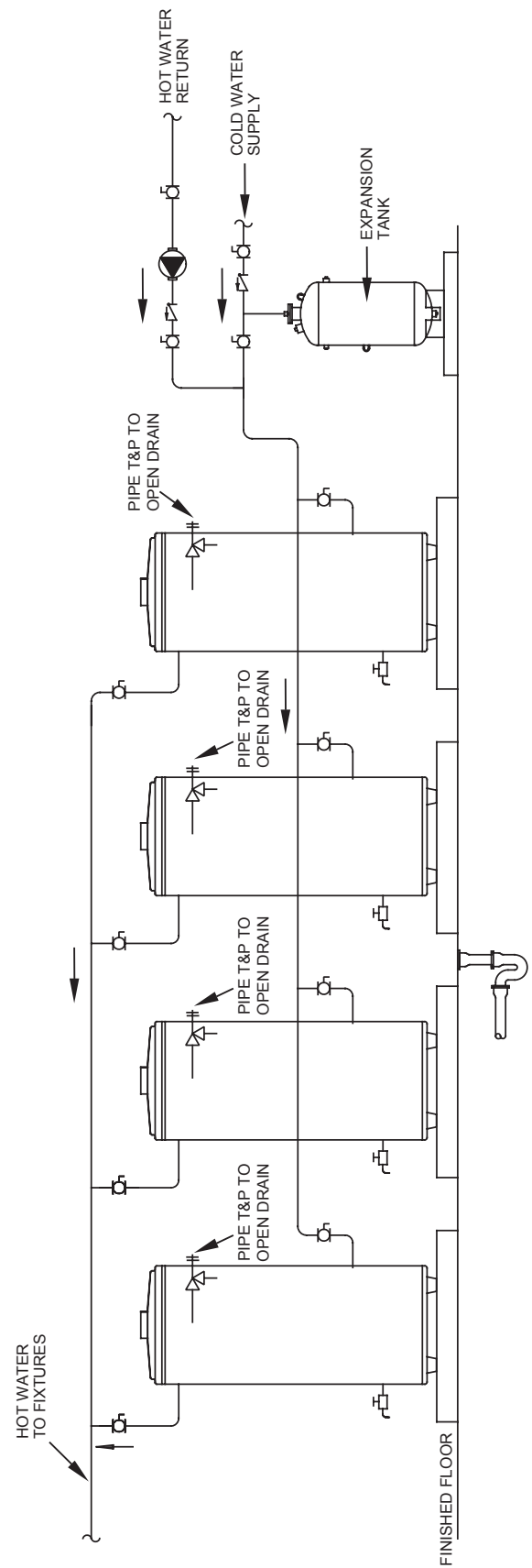



MULTI FLUE FLUE (4 UNITS)

WARNING: THIS DRAWING SHOWS SUGGESTED PIPING CONFIGURATION AND OTHER DEVICES; CHECK WITH LOCAL CODES AND ORDINANCES FOR ADDITIONAL REQUIREMENTS.



- NOTES:**
1. Preferred piping diagram.
 2. The temperature and pressure relief valve setting shall not exceed pressure rating of any component in the system.
 3. Service valves are shown for servicing unit. However, local codes shall govern their usage.

LEGEND

	TEMPERATURE & PRESSURE RELIEF VALVE		FULL PORT BALL VALVE
	PRESSURE RELIEF VALVE		CHECK VALVE
	CIRCULATING PUMP		TEMPERATURE GAGE
	TANK TEMPERATURE CONTROL		WATER FLOW SWITCH
	DRAIN		

MULTI-FLUE (4 UNITS) WITH VERTICAL STORAGE TANK



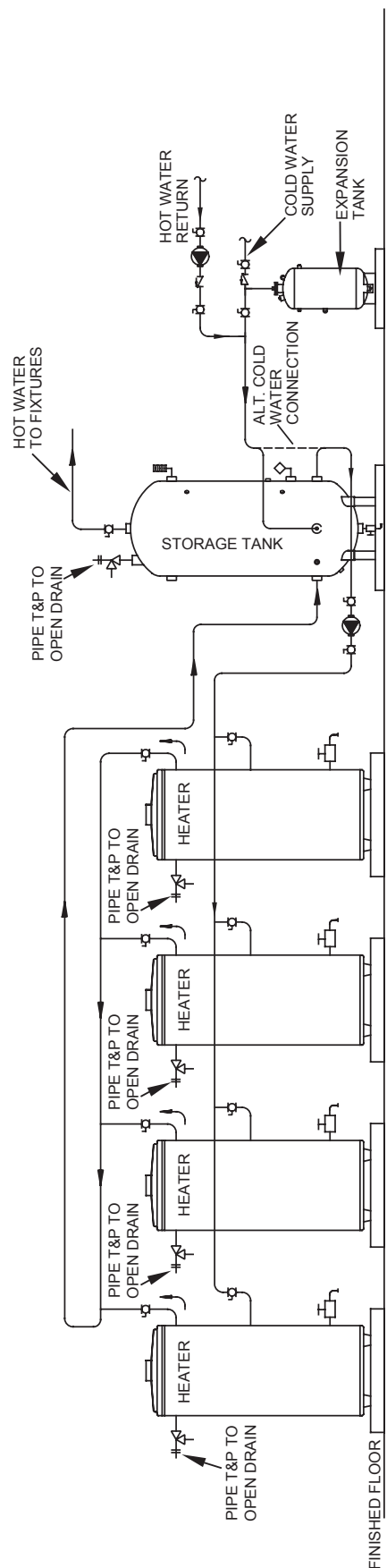





WARNING: THIS DRAWING SHOWS SUGGESTED PIPING CONFIGURATION AND OTHER DEVICES; CHECK WITH LOCAL CODES AND ORDINANCES FOR ADDITIONAL REQUIREMENTS.



NOTES:

1. Preferred piping diagram.
2. The temperature and pressure relief valve setting shall not exceed pressure rating of any component in the system.
3. Service valves are shown for servicing unit. However, local codes shall govern their usage.
4. The Tank Temperature Control should be wired to and control the pump between the water heater(s) and the storage tank(s).
5. The water heater's operating thermostat should be set 5 degrees F higher than the Tank Temperature Control.

LEGEND

	TEMPERATURE & PRESSURE RELIEF VALVE		FULL PORT BALL VALVE
	PRESSURE RELIEF VALVE		CHECK VALVE
	CIRCULATING PUMP		TEMPERATURE GAGE
	TANK TEMPERATURE CONTROL		WATER FLOW SWITCH
	DRAIN		

MULTI-FLUE (4 UNITS) WITH HORIZONTAL STORAGE TANK

WARNING: THIS DRAWING SHOWS SUGGESTED PIPING CONFIGURATION AND OTHER DEVICES; CHECK WITH LOCAL CODES AND ORDINANCES FOR ADDITIONAL REQUIREMENTS.

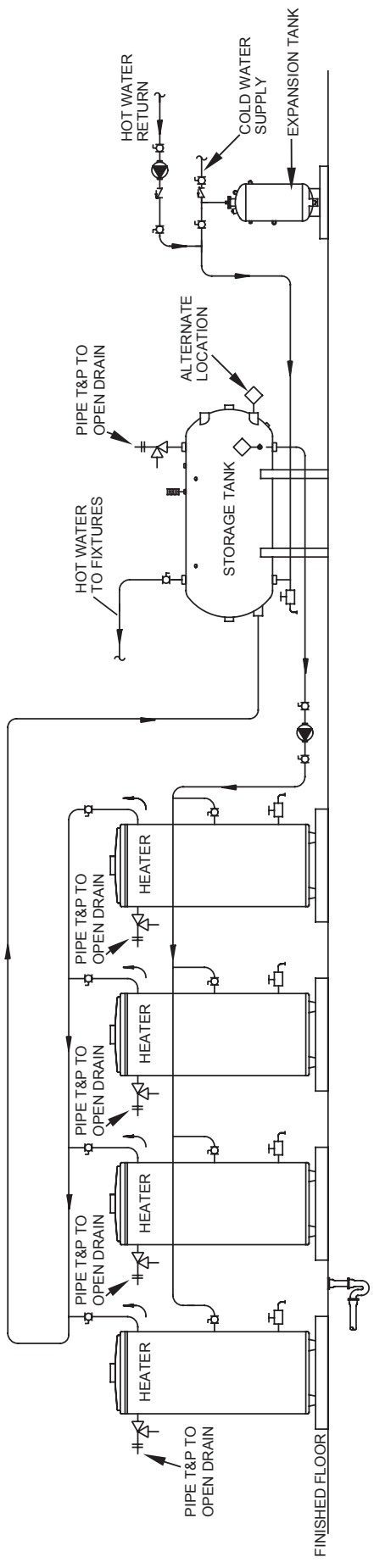

NOTES:

1. Preferred piping diagram.
2. The temperature and pressure relief valve setting shall not exceed pressure rating of any component in the system.
3. Service valves are shown for servicing unit. However, local codes shall govern their usage.
4. The Tank Temperature Control should be wired to and control the pump between the water heater(s) and the storage tank(s).
5. The water heater's operating thermostat should be set 5 degrees F higher than the Tank Temperature Control.

MANIFOLD KITS

Dimensions shown are for minimum space occupied by the water heaters assemblies.

Space for the barometric draft control assemblies, combustion clearances and servicing must be added.

PRIOR TO START UP

IMPORTANT

Factory Start-Up is required for activating warranty and assuring maximum operating performance. Contact your local sales representatives or Authorized Start-Up Agent to arrange a FREE Certified Start-Up.

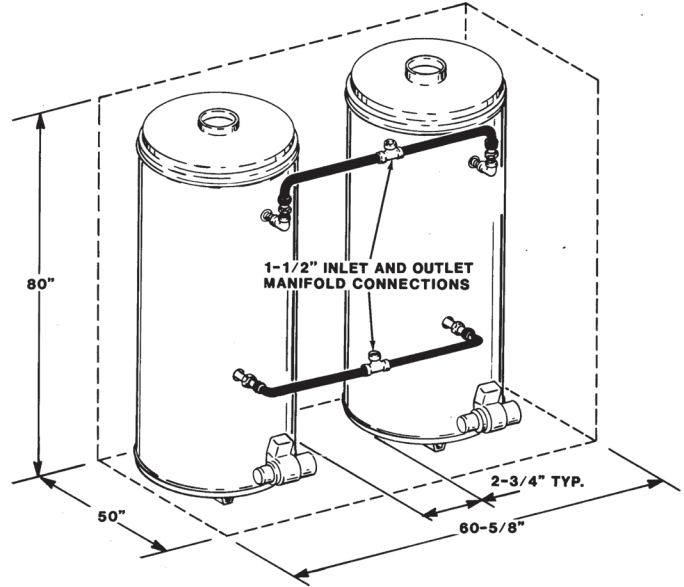

TWO UNIT MANIFOLD KIT
(100109228)

THREE UNIT MANIFOLD KIT
(100109229)

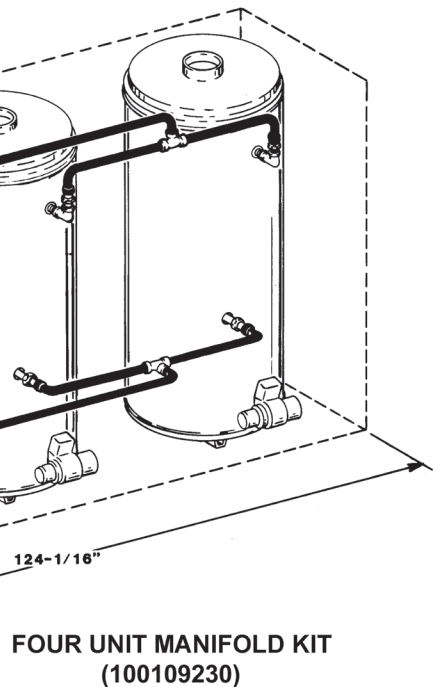
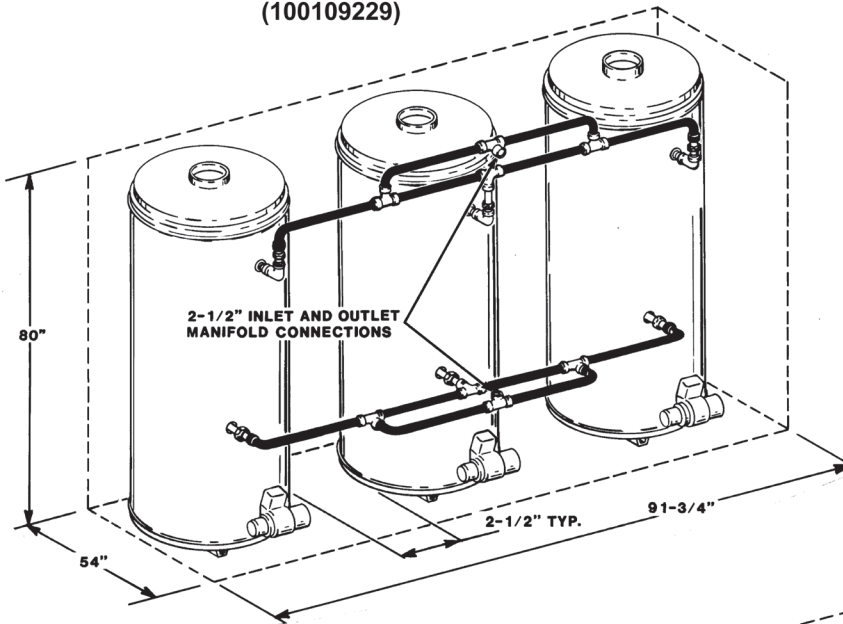

FOUR UNIT MANIFOLD KIT
(100109230)

NOTES

NOTES

Printed on 2/9/2021 9:24 AM CT

**COMMERCIAL
WATER HEATER
LIMITED WARRANTY**



EFFECTIVE

For 3 Years, in the event of a tank leak, we will repair or, at our discretion, replace the defective water heater.

For 1 Year, in the event of part failure, we will repair or, at our discretion, replace the defective part.

We warrant this product against defects in materials or workmanship as described in this document if installed within the United States or Canada and provided the product remains at its original place of installation.

Warranty coverage begins the date of installation OR the date of manufacture if installation cannot be verified.

WHAT'S COVERED

Subject to these terms, in the event of defect in materials and/or workmanship resulting in a **tank leak** during the **first three years**, we will:

- Replace the water heater should the tank leak.

Subject to these terms, in the event of a defect in materials and/or workmanship appearing during the **first year**, we will:

- Repair or, at our discretion, replace any part of the water heater covered under this limited warranty excluding parts subject to normal maintenance (Example: non-electronic anode rod, filter, etc)

Service/labor, shipping, delivery, installation, handling or any other costs are not covered at any time under this warranty.

Any replacement part or product will be warranted only for the unexpired portion of the original water heater's limited warranty period.

If an identical model is no longer available due to a change in law, regulation, or standard, we will replace the product with one having comparable capacity and input. In these instances, the owner will have the option of paying the difference between what was paid for the original model and the new model with the additional features, or receiving a refund of the portion of the purchase price, on a pro-rata basis allocable to the unexpired portion of the warranty.

WHAT'S NOT COVERED

- Problems caused by improper: gas supply line sizing, gas type, venting, connections, combustion air, voltage, wiring, or fusing
- Failure to follow applicable codes
- Failure to follow printed instructions
- Abuse, misuse, accident, fire, flood, Acts of God
- Improper installation, sizing, delivery, or maintenance
- Claims related to rust, noise, smell, or taste of water
- Failure to conduct authorized factory start up if required
- Alterations to the water heater
- Non-outdoor heaters installed outdoors
- Damages due to a failure to allow for thermal expansion
- Heat exchanger failure due to lack of adequate / proper supply of water
- Heaters moved from their original location
- Service trips to explain proper installation, use, or maintenance of the product/unit or to describe compliance requirements under applicable codes and regulations
- Charges related to accessing your heater including but not limited to door/wall removal, equipment rental, etc.
- Replacement parts after expiration of this warranty

LIMITATIONS

NOTWITHSTANDING ANYTHING ELSE TO THE CONTRARY, THIS IS YOUR SOLE AND EXCLUSIVE WARRANTY. ALL OTHER WARRANTIES INCLUDING A WARRANTY OF MERCHANTABILITY OR FITNESS FOR PARTICULAR PURPOSE ARE EXPRESSLY DISCLAIMED. SELLER SHALL NOT BE LIABLE FOR ANY CONSEQUENTIAL, INCIDENTAL, SPECIAL, PUNITIVE OR OTHER INDIRECT DAMAGES. TOTAL LIABILITY ARISING AT ANY TIME SHALL NOT EXCEED THE PURCHASE PRICE PAID WHETHER BASED ON CONTRACT, TORT, STRICT LIABILITY OR ANY OTHER LEGAL THEORY.

SERVICE INQUIRIES:

For service inquiries call the telephone number listed below. Be prepared to provide the following information: name, address, and telephone number; the model and serial number of the water heater; proof of installation; and a clear description of the problem.

For your records, fill in the product:

Serial: _____

Model: _____

U.S. Customers:

A. O. Smith Corporation
500 Tennessee Waltz Parkway
Ashland City, Tennessee 37015
800-527-1953
www.hotwater.com

Canadian Customers:

A. O. Smith Corporation
599 Hill Street W
Fergus, ON N1M 2X1
888-479-8324



500 Tennessee Waltz Parkway, Ashland City, TN 37015
Technical Support: 800-527-1953 • Parts: 800-433-2545
www.hotwater.com